

## ELEMENTI ZA MONTAZU

# Em

PODNOZJA ZA INTEGRISANA KOLA  
PODNOZJA ZA TRANZISTORE  
PODMETAČI  
IZOLATORI ZA TRANZISTORE  
DRZAČI ZA TRANZISTORE  
VIJCI, NAVRTKE I PODMETAČI  
ODSTOJNICI  
KONTAKTNE STOPICE  
UŠICE  
TRNOVI  
MASKE ZA DISPLEJE  
REDNE KLEME  
SISTEM KLEME  
HLADNJACI  
PERTINAKS PLOČE

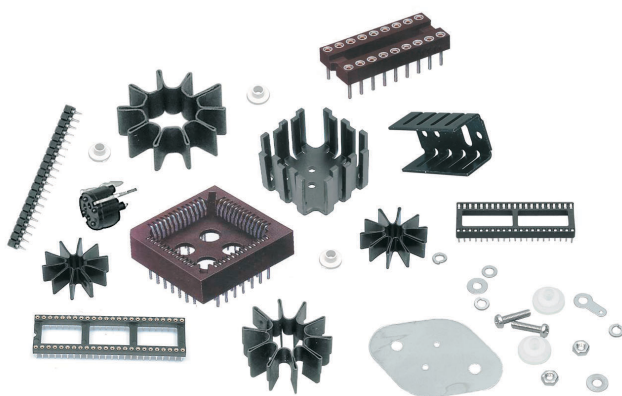

**PODNOZJA ZA INTEGRISANA KOLA . . . . . EMPOIC**  
**STANDARDNA PODNOZJA . . . . . EMPOICS**
**Tehnički podaci:**

Temperaturni opseg:	-55°C ... +125°C
Dubina kontakta:	3,7 mm
Sila kontakta, tipična:	1,8 N/kontaktu
Sila vađenja (čupanja):	0,9 N/kontaktu, tipična
Prelazni otpor:	≤ 10 mΩ/kontaktu
Napon:	100 V RMS / 150 V DC
Kapacitet:	0,3 pF max.
Temperatura lemljenja:	max. 260°C, 5 sec.
Materijal:	Poliester
Pin:	Mesing Nikl, Cink
Kontaktna površina:	Berilijumbakar Nikl
Raster:	2,54 mm

Tip	Pol	Cena
06	6	0,25
08	8	0,12
14	14	0,15
16	16	0,18
18	18	0,20
20	20	0,22
22	22	0,30
24	24	0,32
24U	24	0,35
28	28	0,35
28U	28	0,40
32	32	0,45
40	40	0,60
48	48	0,90
64	64	1,40

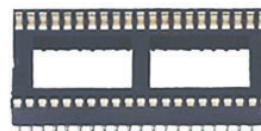

**PROFESIONALNA PODNOZJA . . . . . EMPOICP**
**Tehnički podaci:**

Temperaturni opseg:	-55°C ... +125°C
Dubina kontakta:	3,7 mm
Sila kontakta, tipična:	1,8 N/kontaktu
Sila vađenja (čupanja):	0,9 N/kontaktu, tipična
Prelazni otpor:	≤ 10 mΩ/kontaktu
Napon:	100 V RMS / 150 V DC
Kapacitet:	0,3 pF max.
Temperatura lemljenja:	max. 260°C, 5 sec.
Materijal:	Poliester
Pin:	Mesing Nikl, Cink
Kontaktna površina:	Berilijumbakar Nikl
Raster:	2,54 mm

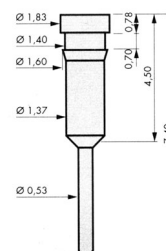
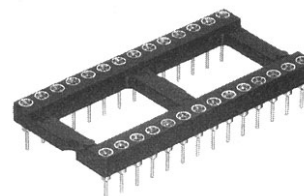
Tip	Pol	Cena
06	6	0,40
08	8	0,50
14	14	0,80
16	16	0,90
18	18	1,00
20	20	1,10
22	22	1,30
24	24	1,40
24U	24	1,40
28	28	1,50
28U	28	1,50
32	32	1,80
40	40	2,20
42	42	3,50
48	48	3,00
64	64	3,50

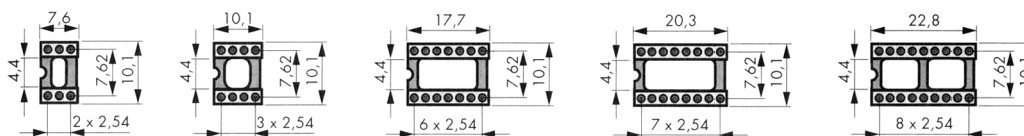

**PODNOZJA ZA INTEGRISANA KOLA . . . . . EMPOIC**  
**DIMENZIJE**



6pol.                      8pol.                      14pol.                      16pol.                      18pol.

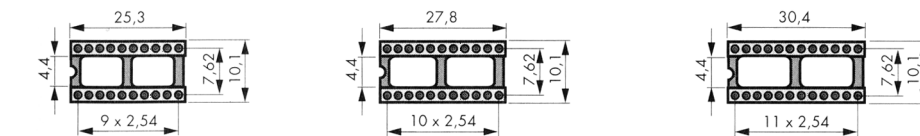

20pol.                      22U                      24U

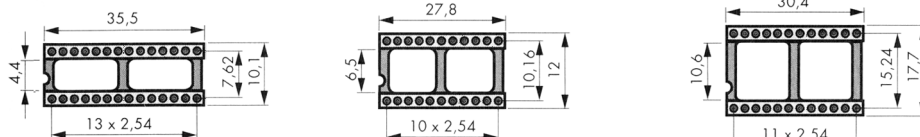

28U                      22pol.                      24pol.

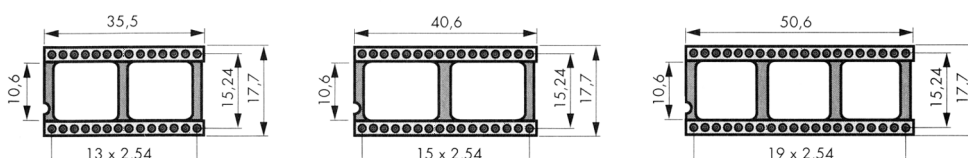

28pol.                      32pol.                      40pol.

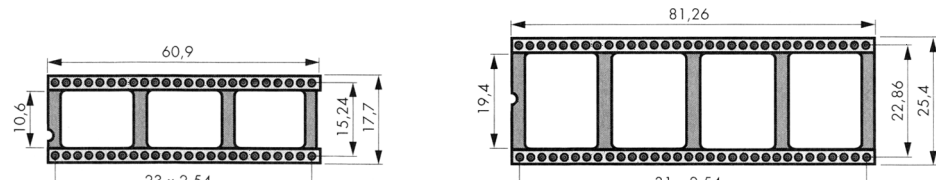

48pol.                      64pol.



**PODNOZJA ZA INTEGRISANA KOLA . . . . . EMPOIC**  
**PODNOZJA RASTER 1,778 mm . . . . . EMPOICU**

**Tehnički podaci:**

Temperaturni opseg: -55°C ... +125°C  
 Dubina kontakta: 3,7 mm  
 Sila kontakta, tipična: 1,8 N/kontaktu  
 Sila vađenja (čupanja): 0,9 N/kontaktu, tipična  
 Prelazni otpor: ≤ 10 mΩ/kontaktu  
 Napon: 100 V RMS / 150 V DC  
 Kapacitet: 0,3 pF max.  
 Temperatura lemljenja: max. 260°C, 5 sec.  
 Materijal: Poliester  
 Pin: Mesing  
 Nikl, Cink  
 Kontaktna površina: Berilijumbakar  
 Nikl  
 Raster: 1,778 mm

Tip	Pol	Cena
24	24	1,80
28	28	2,00
30	30	2,50
40	40	3,00
42	42	3,50
48	48	4,50
52	52	4,50
56	56	4,50
64	64	4,50

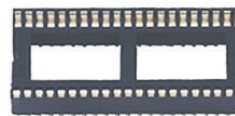

**TEST PODNOZJA . . . . . EMPOICT**

**Tehnički podaci:**

Temperaturni opseg: -55°C ... +125°C  
 Dubina kontakta: 3,7 mm  
 Sila kontakta, tipična: 1,8 N/kontaktu  
 Sila vađenja (čupanja): 0,9 N/kontaktu, tipična  
 Prelazni otpor: ≤ 10 mΩ/kontaktu  
 Napon: 100 V RMS / 150 V DC  
 Kapacitet: 0,3 pF max.  
 Temperatura lemljenja: max. 260°C, 5 sec.  
 Materijal: Poliester  
 Pin: Mesing  
 Nikl, Cink  
 Kontaktna površina: Berilijumbakar  
 Nikl

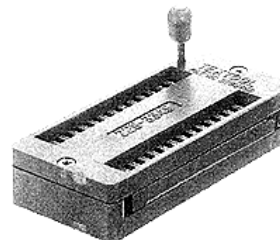

Tip	Pol	Cena	Dimenzije u mm				
			A	B	C	D	Z
14	14	26,00	33,0	15,2	28,2	7,62	6
16	16	30,00	35,3	15,2	30,7	7,62	7
18	18	32,00	37,8	15,2	33,3	7,62	8
20	20	32,00	40,4	15,2	35,8	7,62	9
24	24	34,00	45,5	22,9	40,9	15,24	11
28	28	36,00	50,5	22,9	46,2	15,24	13
40	40	56,00	66,0	22,9	61,5	15,24	19

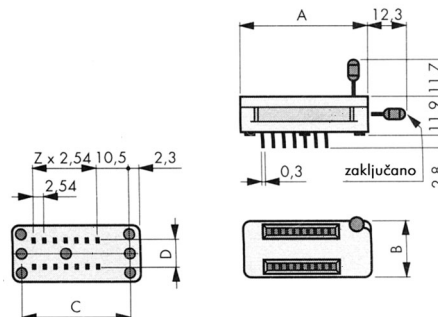

**PODNOZJA ZA INTEGRISANA KOLA . . . . . EMPOIC**  
**PLCC CHIP PODNOZJA . . . . . EMPOICCHIP**

**Tehnički podaci:**

Temperaturni opseg: -55°C ... +105°C  
 Prelazni otpor: 5 mΩ tipično  
 Otpor izolacije: > 1000 MΩ  
 Napon: > 500 V RMS  
 Struja: 1 A  
 Kontakt površina: Fosfor-Bronza  
 Zink preko Bakra

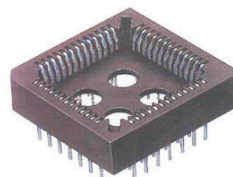

Tip	Pol	Cena	Dimenzije u mm			
			A	B	C	D
20	20	2,30	5,08	15,58	18,30	10,16
28	28	2,40	7,62	18,12	21,87	12,70
32	32	2,60	7,62	17,66	23,60	15,24
44	44	2,70	12,70	22,80	29,00	17,78
52	52	2,90	15,24	26,92	32,57	20,32
68	68	3,00	20,32	30,60	39,70	25,40
84	84	3,50	25,40	35,70	46,90	30,48

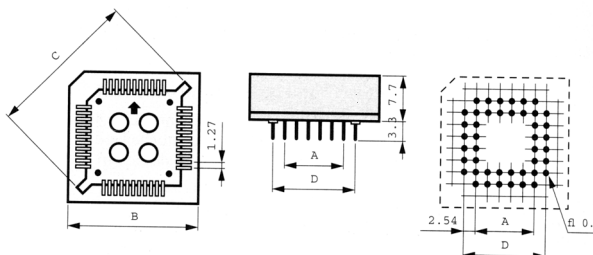

**PLCC SMD PODNOZJA . . . . . EMPOICPLCC**

**Tehnički podaci:**

Temperaturni opseg: -55°C ... +105°C  
 Prelazni otpor: 5 mΩ tipično  
 Otpor izolacije: > 1000 MΩ  
 Napon: > 500 V RMS  
 Struja: 1 A  
 Kontakt površina: Fosfor-Bronza  
 Zink preko Bakra

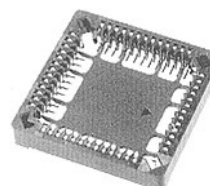

Tip	Pol	Cena	Dimenzije u mm			
			A	B	C	D
20	20	2,50	5,08	16,70	16,70	5,08
28	28	2,60	7,62	18,12	20,30	7,62
32	32	2,80	7,62	18,12	22,50	10,16
44	44	3,00	12,70	23,20	27,50	12,70
52	52	3,50	15,24	25,74	31,10	15,24
68	68	4,00	20,32	30,82	38,30	20,32
84	84	4,20	25,40	35,90	45,50	25,40

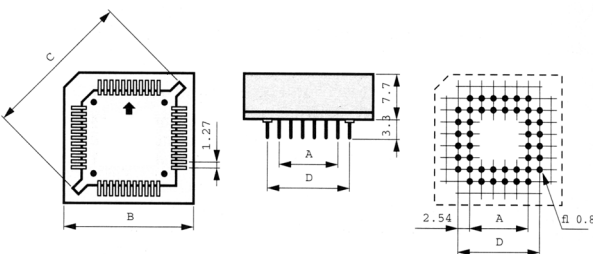

**PODNOZJA ZA INTEGRISANA KOLA . . . . . EMPOIC**  
**PODNOZJA ZA IC TO . . . . . EMPOICTO**

**Tehnički podaci:**

Temperaturni opseg: -55°C ... +105°C  
 Prelazni otpor: 5 mΩ tipično  
 Otpor izolacije: > 1000 MΩ  
 Napon: > 500 V RMS  
 Struja: 1 A

Tip	Pol	Cena
99	8	6,00
100	10	7,00

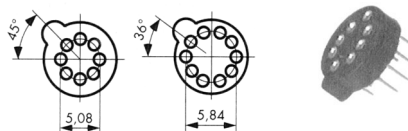

**SIL PODNOZJA . . . . . EMPOICSIL**

**Tehnički podaci:**

Temperaturni opseg: -55°C ... +105°C  
 Prelazni otpor: 5 mΩ tipično  
 Otpor izolacije: > 1000 MΩ  
 Napon: > 500 V RMS  
 Struja: 1 A

**ZENSKA**

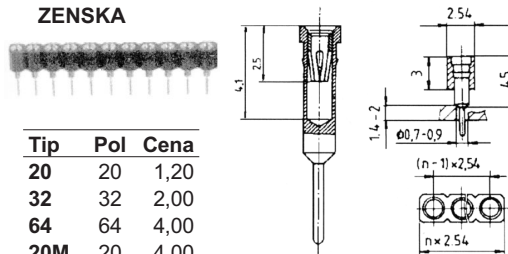

Tip	Pol	Cena
20	20	1,20
32	32	2,00
64	64	4,00
20M	20	4,00

**KONTAKTNI PINOVI**

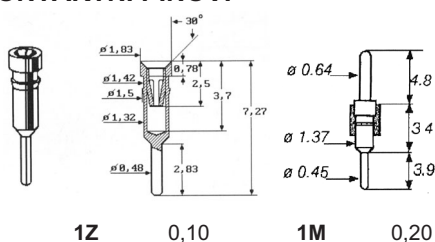

**1Z** 0,10      **1M** 0,20

**MUŠKA**

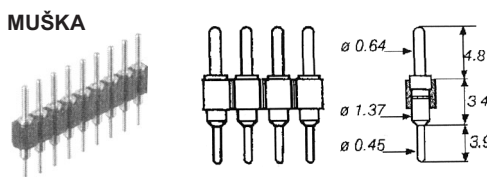

**PODNOZJA ZA TRANZISTORE . . . . . EMPOTR**

**Tehnički podaci:**

Temperaturni opseg: -55°C ... +105°C  
 Prelazni otpor: 5 mΩ tipično  
 Otpor izolacije: > 1000 MΩ  
 Napon: > 500 V RMS  
 Struja: 1 A  
 Kontakt površina: Fosfor-Bronza  
 Zink preko Bakra

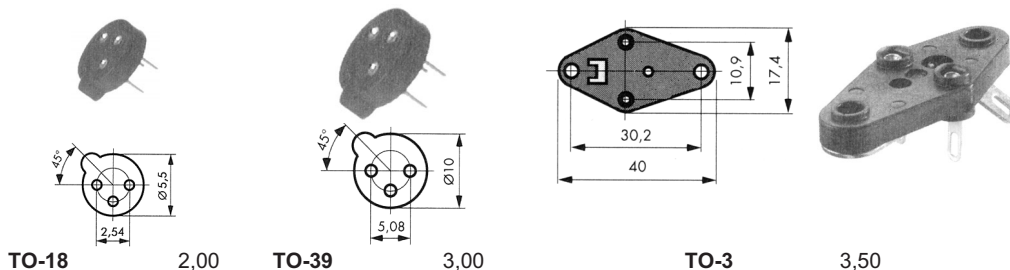

**TO-18** 2,00      **TO-39** 3,00      **TO-3** 3,50

18000 Niš, Jovana Ristića 7, P.O.Box 135, Tel: 018 / 520-455, 522-814, 522-965, fax: 522-660  
<http://www.MGelectronic.co.yu> e-mail: [office@MGelectronic.co.yu](mailto:office@MGelectronic.co.yu)

## ELEMENTI ZA MONTAZU

EM

**PODMETAČI** . . . . . **EMPOD**

**PODMETAČI ZA DIODE** . . . . . **EMPODD**

**Tehnički podaci:**

Materijal: Polyamid  
Radna temperatura: +145°C

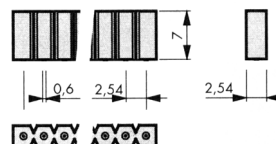

Cena: 0,40

**PODMETAČI ZA INTEGRISANA KOLA** . . . . . **EMPODIC**

**Tehnički podaci:**

Materijal: Polyamid  
Radna temperatura: +145°C

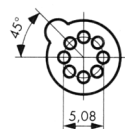

TO-99 0,50

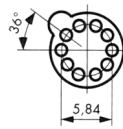

TO-100 0,60



**PODMETAČI ZA TRANZISTORE** . . . . . **EMPODTR**

**Tehnički podaci:**

Materijal: Polyamid  
Radna temperatura: +145°C

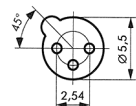

TO-18 0,35

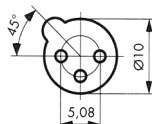

TO-39 0,40



**IZOLATORI ZA TRANZISTORE** . . . . . **EMIZ**

**PLASTIČNI IZOLATORI** . . . . . **EMIZPL**

**Tehnički podaci:**

Temperaturni opseg: -55°C ... +105°C  
Prelazni otpor: 5 mΩ tipično  
Otpor izolacije: > 1000 MΩ



Tip	Cena	Dimenzije u mm				
		D	d <sub>1</sub>	d <sub>2</sub>	H	S
TO3 / TOP3	0,10	7,1	3,1	3,8	3,5	1,0
TO126	0,17	8,0	2,6	3,0	4,4	2,1
TO220	0,10	6,0	3,1	3,5	2,2	1,0

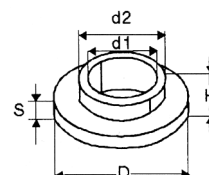

**IZOLATORI ZA TRANZISTORE . . . . . EMIZ**  
**LISKUNSKI IZOLATORI . . . . . EMIZLI**

**Tehnički podaci:**

Probojni napon: 2,4 kV  
Dielektrična konstanta: 3,5 (10<sup>6</sup> Hz)  
Zapreminska otpornost: 10<sup>13</sup> ... 10<sup>17</sup> Ω/cm  
Tačka topljenja: 1260°C ... 1290°C

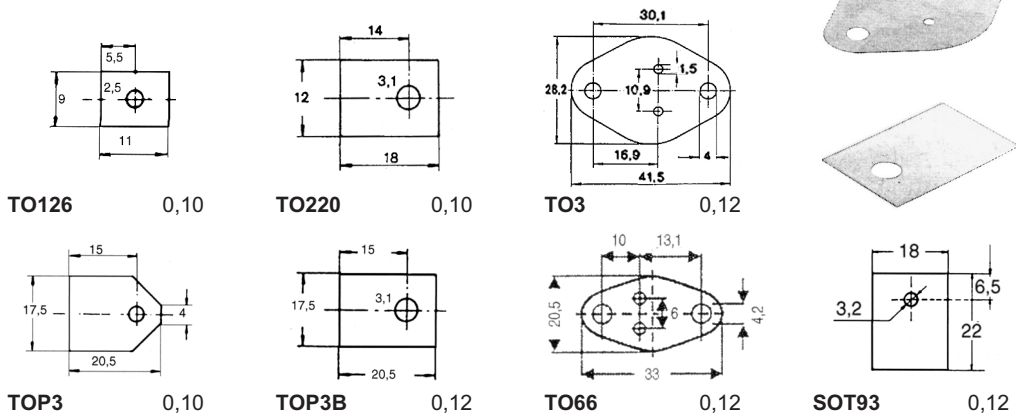

**SILIKONSKI IZOLATORI . . . . . EMIZSI**

**Tehnički podaci:**

Boja: Sivo-zelena  
Toplotna odvodnost: (P<sub>C</sub>: 30W (30A, 10V)): 0,4 °C/W  
Probojna otpornost: 10 kV/mm  
Zapreminska otpornost: 2,9 x 10<sup>15</sup> Ω/cm  
Temperaturni opseg: -60°C ... +180°C  
Debljina: 0,3<sup>+0,1</sup> mm

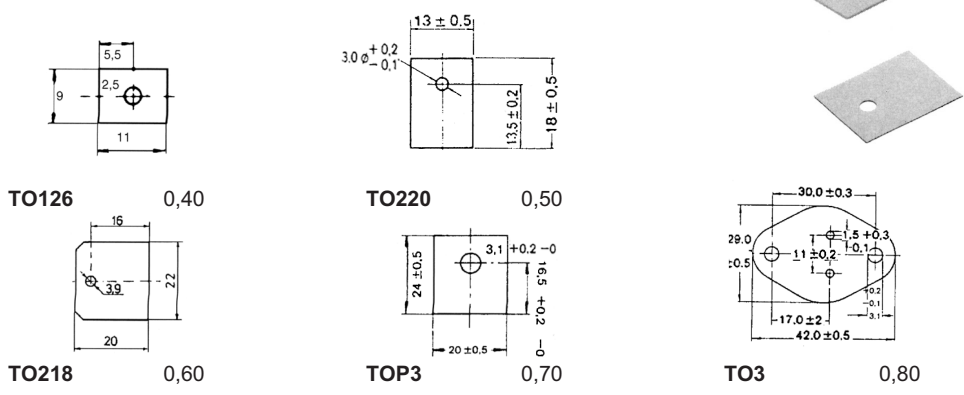

18000 Niš, Jovana Ristića 7, P.O.Box 135, Tel: 018 / 520-455, 522-814, 522-965, fax: 522-660  
<http://www.MGelectronic.co.yu> e-mail: [office@MGelectronic.co.yu](mailto:office@MGelectronic.co.yu)



**ELEMENTI ZA MONTAZU**

**EM**

**IZOLATORI ZA TRANZISTORE . . . . . EMIZ**

**KOMPLET IZOLATORA . . . . . EMIZK**

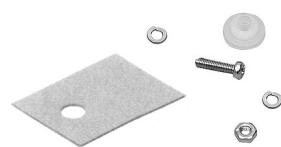

- TO220** ..... 0,80  
 Izolator plastični TO 220 1 kom.  
 Izolator liskunski 1 kom.  
 Vijak M3 x 10 1 kom.  
 Navrtka M3 1 kom.  
 Elastični podmetač B3 1 kom.  
 Ravni podmetač B3 1 kom.

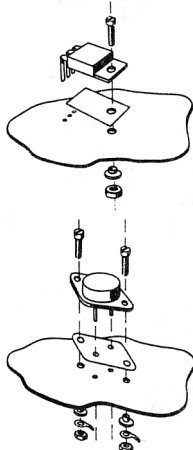

- TO3** ..... 1,20  
 Izolator plastični TO3 2 kom.  
 Izolator liskunski 1 kom.  
 Vijak M3 x 10 2 kom.  
 Ušica M3 1 kom.  
 Navrtka M3 2 kom.  
 Elastični podmetač B3 2 kom.  
 Ravni podmetač B3 2 kom.

**ZAŠTITNE KAPE . . . . . EMIZZK**

**Tehnički podaci:**

- Boja: Sivo-zelena  
 Toplotna odvodnost: (Pc: 30W (30A, 10V)): 0,4 °C/W  
 Probijna otpornost: 10 kV/mm  
 Zapreminska otpornost: 2,9 x 10<sup>15</sup> Ω/cm  
 Temperaturni opseg: -60°C ... +180°C  
 Debljina: 0,3<sup>+0,1</sup> mm

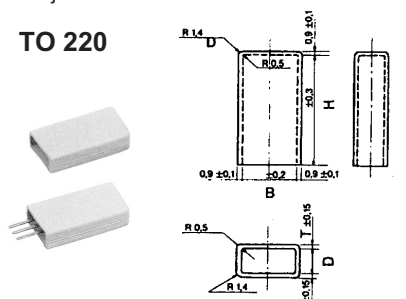

Cena: 2,00

Dimenzije u mm

H	B	D	T
22,5	11,0	4,5	0,30

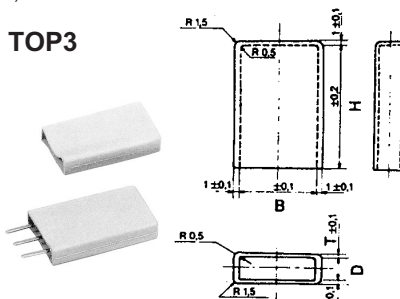

Cena: 2,50

Dimenzije u mm

H	B	D	T
28,1	16,0	4,5	0,30



Cena: 2,50

**DRŽAČI ZA TRANZISTORE . . . . . EMDT**

**TO 220**

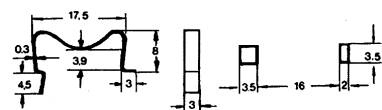

Cena: 0,40

**TO 247**

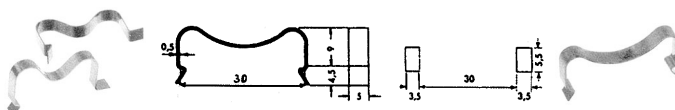

Cena: 1,00

18000 Niš, Jovana Ristića 7, P.O.Box 135, Tel: 018 / 520-455, 522-814, 522-965, fax: 522-660  
<http://www.MGelectronic.co.yu> e-mail: [office@MGelectronic.co.yu](mailto:office@MGelectronic.co.yu)

**VIJCI, NAVRTKE I PODMETAČI . . . . . EMVI**

**VIJCI M2,5 DIN 84**

Tip	Cena	Dimenzije u mm						
		d <sub>1</sub>	l	d <sub>2</sub>	k	n	t <sub>min</sub>	t <sub>max</sub>
2,5x4	0,07	M2,5	4	4,5	1,6	0,6	0,7	0,9
2,5x6	0,05	M2,5	6	4,5	1,6	0,6	0,7	0,9
2,5x8	0,05	M2,5	8	4,5	1,6	0,6	0,7	0,9

**VIJCI M3 DIN 84**

Tip	Cena	Dimenzije u mm						
		d <sub>1</sub>	l	d <sub>2</sub>	k	n	t <sub>min</sub>	t <sub>max</sub>
3x6	0,05	M3	6	5,5	2,0	0,8	0,9	1,15
3x8	0,05	M3	8	5,5	2,0	0,8	0,9	1,15
3x10	0,05	M3	10	5,5	2,0	0,8	0,9	1,15
3x12	0,06	M3	12	5,5	2,0	0,8	0,9	1,15
3x16	0,07	M3	16	5,5	2,0	0,8	0,9	1,15
3x20	0,08	M3	20	5,5	2,0	0,8	0,9	1,15

**VIJCI M4 DIN 84**

Tip	Cena	Dimenzije u mm						
		d <sub>1</sub>	l	d <sub>2</sub>	k	n	t <sub>min</sub>	t <sub>max</sub>
4x8	0,10	M4	8	7,0	2,6	1,0	1,2	1,5
4x10	0,12	M4	10	7,0	2,6	1,0	1,2	1,5
4x16	0,15	M4	16	7,0	2,6	1,0	1,2	1,5

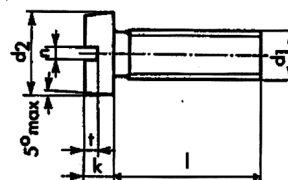

**NAVRTKE DIN 934 . . . . . EMVIN**

Tip	Cena	Dimenzije u mm	
		m	sw
2,5	0,05	2,0	5,0
3	0,05	2,4	5,5
4	0,05	3,2	7,0

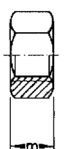

**PODMETAČI DIN 125 . . . . . EMVIP**

**RAVNI**

Tip	Cena	Dimenzije u mm		
		d <sub>1</sub>	l	d <sub>2</sub>
R3	0,05	3,2	6,8	0,5
R4	0,05	4,3	8,8	0,8

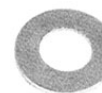
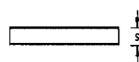
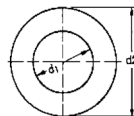

**ELASTIČNI, ZVEZDASTI**

Tip	Cena	Dimenzije u mm	
		d <sub>1</sub>	l
E3	0,05	3,2	6,0
E4	0,05	4,3	8,0

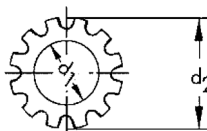

**ODSTOJNICI. . . . . EMOD**

**ODSTOJNICI ZA ŠTAMPANE PLOČE**

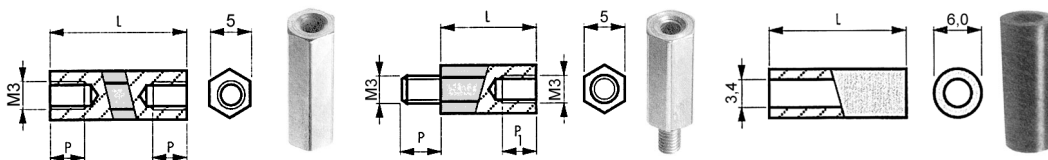

Tip	Cena	Dimenzije u mm	
		L	P
105	0,25	5	5
110	0,30	10	10
115	0,40	15	10
120	0,50	20	10
125	0,55	25	10
130	0,60	30	10
135	0,70	35	10
140	0,80	40	10
145	0,90	45	10
150	1,00	50	10

Tip	Cena	Dimenzije u mm		
		L	P	P <sub>1</sub>
205	0,25	5	8	3
210	0,30	10	8	5
215	0,40	15	8	8
220	0,50	20	8	8
225	0,55	25	10	10
230	0,60	30	10	10
235	0,70	35	10	10
240	0,80	40	10	10
245	0,90	45	10	10
250	1,00	50	10	10

Tip	Cena	Dim. u mm
		L
305	0,06	5
310	0,07	10
315	0,08	15
320	0,09	20
325	0,10	25
330	0,13	30
335	0,16	35

**ODSTOJNICI UNC**



**UNC05** 0,40

**UNC/M3** 0,50

**ODSTOJNICI ZA KUTIJE**

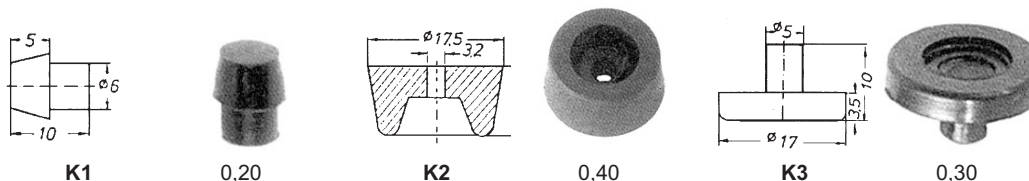

**K1** 0,20

**K2** 0,40

**K3** 0,30

**ODSTOJNICI PVC**

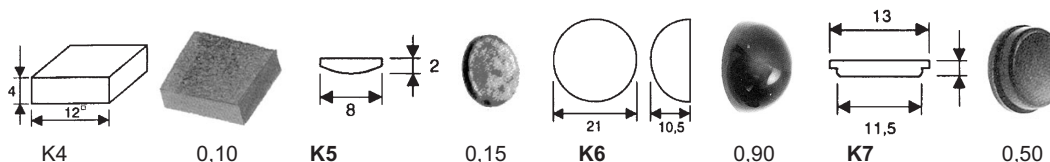

**K4** 0,10

**K5** 0,15

**K6** 0,90

**K7** 0,50

18000 Niš, Jovana Ristića 7, P.O.Box 135, Tel: 018 / 520-455, 522-814, 522-965, fax: 522-660  
<http://www.MGelectronic.co.yu> e-mail: [office@MGelectronic.co.yu](mailto:office@MGelectronic.co.yu)

**KONTAKTNE STOPICE . . . . . EMKS**

**2,8 mm . . . . . EMKS2,8**

Tip	Dimenzije u mm						
	b <sub>1</sub>	b <sub>2</sub>	l <sub>1</sub>	l <sub>2</sub>	l <sub>3</sub>	a	s
01	5,0	1,5	12,5	4,0	7,0		0,5
02	2,8	1,3	10,5	3,5	7,0		0,8
03	2,8	1,3	10,5	3,5	7,0		0,8
04	6,0	1,2	18,0	4,0	12,5	4,0	0,8
05	8,0	1,2	13,5	3,0		5,0	0,8

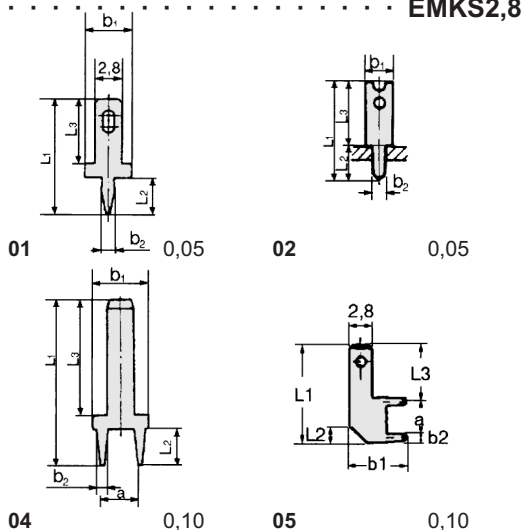

**4,8 mm . . . . . EMKS4,8**

Tip	Dimenzije u mm						
	b <sub>1</sub>	b <sub>2</sub>	l <sub>1</sub>	l <sub>2</sub>	l <sub>3</sub>	a	s
01	6,5	1,3	12,8	4,0	7,0	5,2	0,8
02	10,8	1,2	13,5	3,0	7,2	5,0	0,8

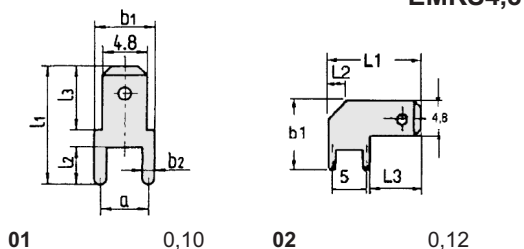

**6,3 mm . . . . . EMKS6,3**

Tip	Dimenzije u mm							
	b <sub>1</sub>	d <sub>2</sub>	l <sub>1</sub>	l <sub>2</sub>	l <sub>3</sub>	l <sub>4</sub>	w	s
01	7,0	4,3	15,0	8,0				0,8
02	7,0	4,3	19,0	8,0	5,0	10,0	45°	0,8
03	8,0	4,3	19,0	8,0	8,0		30°	0,8
04	7,0	3,2	8,8	8,0	11,5		U	0,8
05	8,0		14,0	4,0	8,0			0,8
06	12,0		16,2	3,0	8,0			0,8

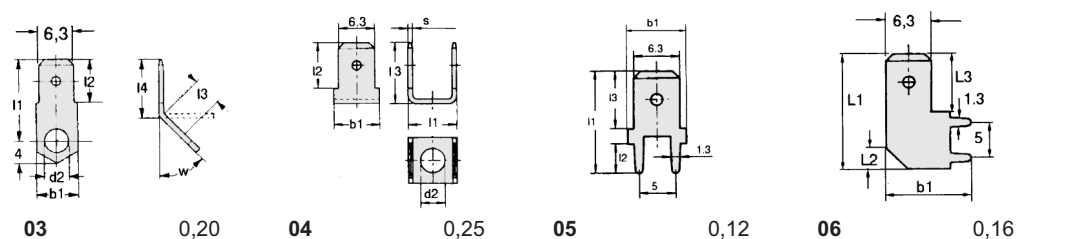
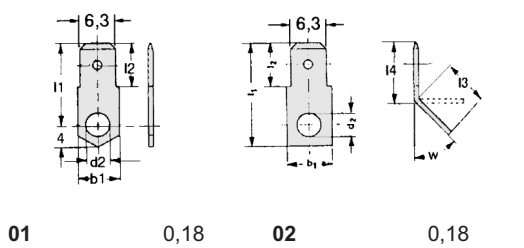

18000 Niš, Jovana Ristića 7, P.O.Box 135, Tel: 018 / 520-455, 522-814, 522-965, fax: 522-660  
<http://www.MGelectronic.co.yu> e-mail: [office@MGelectronic.co.yu](mailto:office@MGelectronic.co.yu)

**ELEMENTI ZA MONTAZU**

**EM**

**UŠICE . . . . . EMUS**

Tip	Cena	Dimenzije u mm						
		d	D	b	l	s	n	t
M3	0,05	3,2	5,5	3	12	0,5	1,7	3,2
M4	0,06	4,3	6,5	3	18	0,3	1,7	3,2

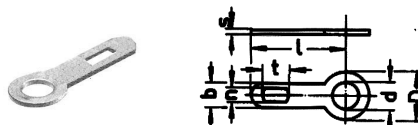

**TRNOVI. . . . . EMTR**

Tip	Cena	Dimenzije u mm			
		d <sub>1</sub>	d <sub>2</sub>	L	l <sub>1</sub>
1	0,06	1,0	2,0	10,0	3,5
1,3	0,06	1,3	2,5	11,0	4,5

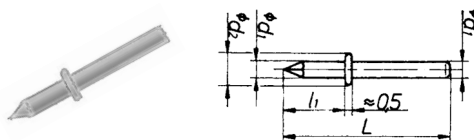

**MASKE ZA DISPLEJE . . . . . EMMD**

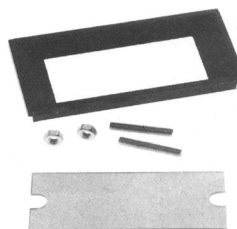
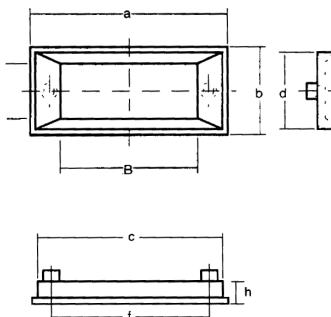

Tip	Cena	Dimenzije u mm						
		a	b	c	d	f	B	H
2	3,00	47	32	42	28	33	25	19
3	3,00	59	32	55	28	45	38	19
4	4,00	70	32	66	28	58	50	19
5	5,00	81	32	77	28	71	63	19
6	5,50	97	32	93	28	83	77	19

**REDNE KLEME . . . . . EMRK**

**Tehnički podaci:**

Nominalni napon: 250 V  
 Nominalna struja: 24 A  
 Ispitni napon: 2 kV  
 Presek: 2,5 mm<sup>2</sup>  
 Dužina skidanja izolacije: 7,0 mm  
 Temperaturni opseg: -30°C ... 105°C

**VERTIKALNE**

Tip	Cena	Dimenzije u mm		
		L	H	T
V02	0,70	10	12,5	9
V03	1,00	15	12,5	9

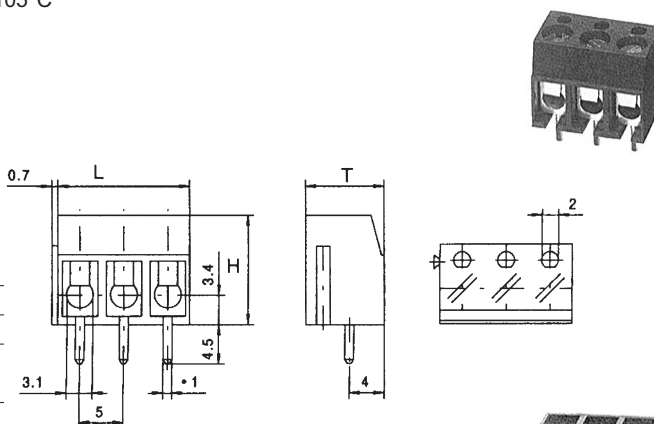

**HORIZONTALNE**

Tip	Cena	Dimenzije u mm		
		L	H	T
H02	1,00	10	12,5	9
H03	1,40	15	12,5	9

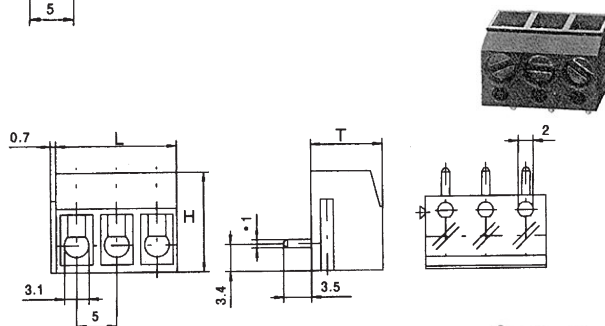

**UGAONE – 45°**

Tip	Cena	Dimenzije u mm		
		L	H	T
U02	1,20	10	12,5	12,5
U03	1,60	15	12,5	12,5

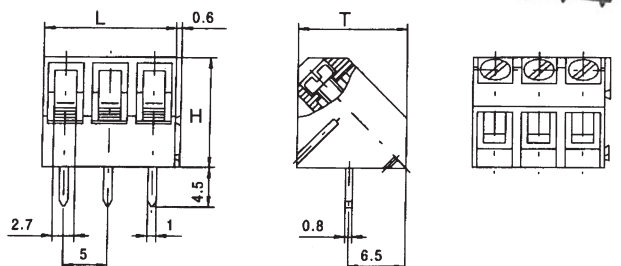

18000 Niš, Jovana Ristića 7, P.O.Box 135, Tel: 018 / 520-455, 522-814, 522-965, fax: 522-660  
<http://www.MGelectronic.co.yu> e-mail: [office@MGelectronic.co.yu](mailto:office@MGelectronic.co.yu)

**SISTEM KLEME . . . . . EMSK**

**Tehnički podaci:**

Nominalni napon: 250 V  
 Nominalna struja: 12 A  
 Ispitni napon: 2,2 kV  
 Raster: 5,08 mm  
 Temperaturni opseg: -30°C ... 105°C

**VERTIKALNE**

Tip	Cena	Dimenzije u mm		
		L	H	T
V2	1,00	11,36	12,00	8,4
V3	1,50	16,44	12,00	8,4
V4	1,80	21,52	12,00	8,4
V5	2,20	26,60	12,00	8,4
V6	2,60	31,68	12,00	8,4
V02	1,00	10,16	12,00	8,4
V03	1,50	15,24	12,00	8,4

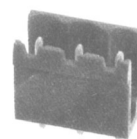
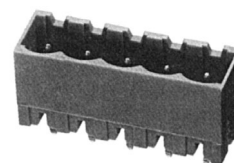
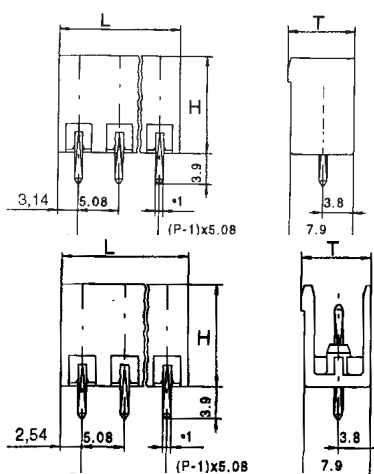

**HORIZONTALNE**

Tip	Cena	Dimenzije u mm		
		L	H	T
H2	1,00	11,36	8,4	12,00
H3	1,50	16,44	8,4	12,00
H4	1,80	21,52	8,4	12,00
H5	2,20	26,60	8,4	12,00
H6	2,60	31,68	8,4	12,00
H02	1,00	10,16	8,4	12,00
H03	1,50	15,24	8,4	12,00

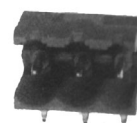
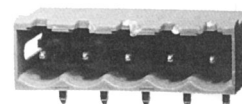
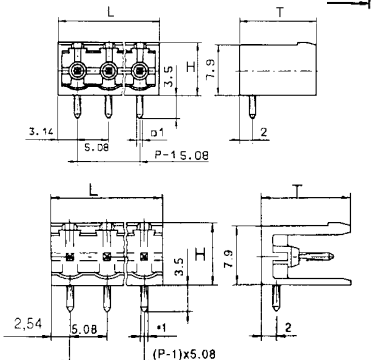

**UGAONE**

Tip	Cena	Dimenzije u mm		
		L	H	T
U2	2,50	10,16	15,00	17,3
U3	3,60	15,24	15,00	17,3
U4	4,80	20,32	15,00	17,3
U5	6,00	25,40	15,00	17,3
U6	7,00	30,48	15,00	17,3

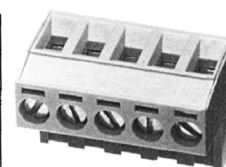
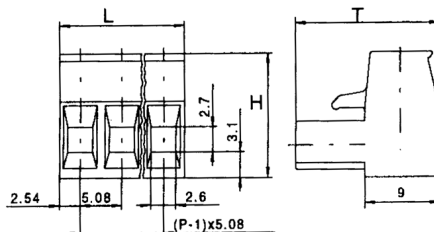



TO18 ..... 0,90



TO39 ..... 1,10

**TO126**

Tip	cena	zaštita	toplotna odvodnost k/w
TO126	0,40		22
TO126E	0,60	ELOX	21

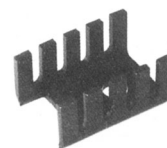
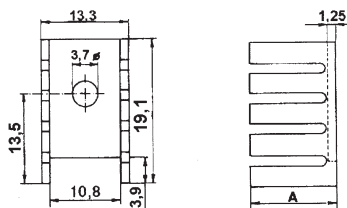

**TO220**

Tip	cena	zaštita	toplotna odvodnost k/w
TO220	0,40		17
TO220E	0,80	ELOX	16
TO220/1	0,70		15
TO220/1E	1,00	ELOX	14

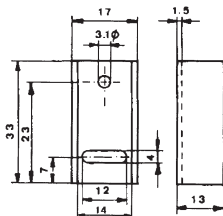

TO220

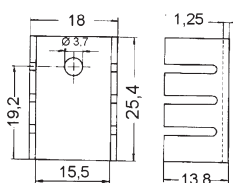

TO220/1

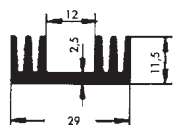
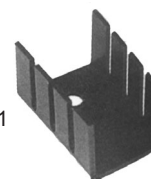

Tip	cena	zaštita	toplotna odvodnost k/w
TO220/2	2,50	ELOX	15

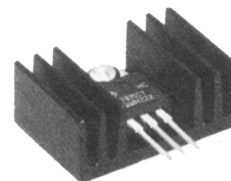
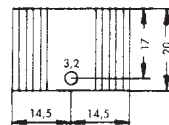

Tip	cena	zaštita	toplotna odvodnost k/w	Dužina (L)
TO220/25	4,00	ELOX	14	25,4
TO220/38	4,50	ELOX	11	38,1
TO220/51	5,00	ELOX	9	50,8
TO220/D	0,50	DRZAČ		

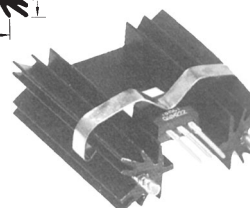
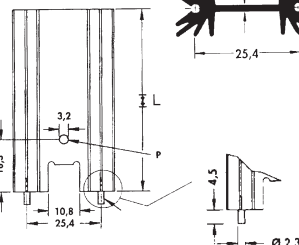

18000 Niš, Jovana Ristića 7, P.O.Box 135, Tel: 018 / 520-455, 522-814, 522-965, fax: 522-660  
<http://www.MGelectronic.co.yu> e-mail: [office@MGelectronic.co.yu](mailto:office@MGelectronic.co.yu)



**HLADNJACI . . . . . EMHL**

**TOP3**

Tip	cena	zaštita	toplotna odvodnost k/w
TOP3	1,40		11
TOP3E	2,00	ELOX	10

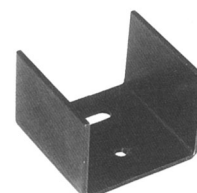
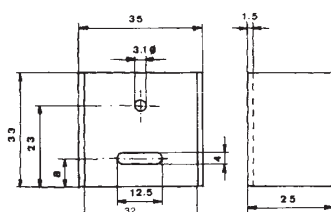

**TO3**

Tip	Dimenzije (mm)	Cena
050	100x28x50	9,00
075	100x28x75	12,00
100	100x28x100	15,00
120	100x28x120	18,00
160	100x28x160	22,00
200	100x28x200	25,00
300	100x28x300	34,00
500	100x28x500	52,00

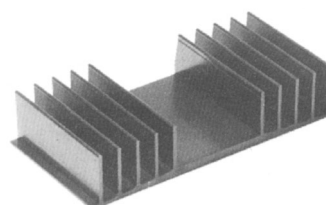
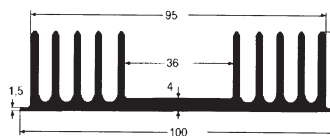

Tip	Dimenzije	Cena
R	45x45x25,4	2,80

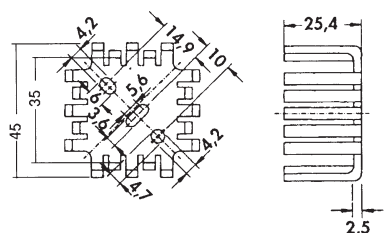

**RHT**

Tip	Cena	Dimenzije u mm			
		a	b	c	navoj
1	18,00	60	35	45	4
2	22,00	80	40	60	6
3	36,00	80	65	100	20
4	40,00	140	100	100	20

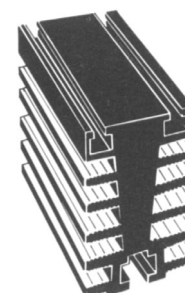
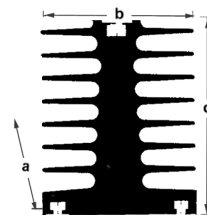

**IC**

Tip	cena	Dužina (mm)	toplotna odvodnost k/w
14/16	1,60	19	50
24/28	2,00	33	13

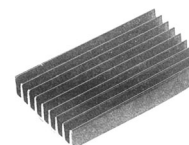
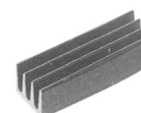
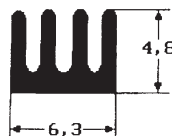

**PERTINAKS PLOČE . . . . . EMPE**

**JEDNOSTRANE**

Tip	Dimenzije	Cena	
		FR3	FR4
J1	50x100	0,80	
J2	75x100	1,00	
J3	100x100	1,50	
J4	160x100	2,00	4,00
J5	160x200	3,50	8,00
J6	180x200	4,50	9,00
J7	300x160	7,00	14,00

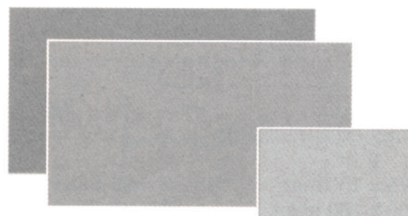

debljina: 1,5 mm  
CU: 35 μ

**DVOSTRANE**

Tip	Dimenzije	Cena
D1	160x100	6,00
D2	150x200	9,00
D3	200x200	12,00
D4	300x200	16,00

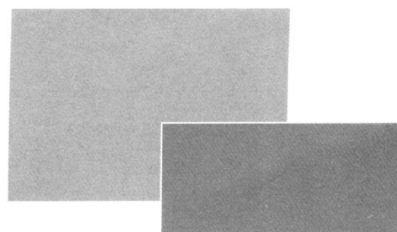

debljina: 1,5 mm  
CU: 2x35 μ

**FOTO**

Tip	Dimenzije	Cena	
		Jednostrana	Dvostrana
F1	50x100	2,00	
F2	75x100	3,00	
F3	160x100	6,00	9,00
F4	200x150	9,00	12,00
F5	300x200	22,00	26,00

debljina: 1,5 mm  
CU: 35 μ

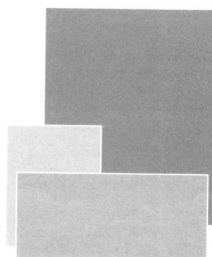

**RASTER PLOČE . . . . . EMRP**

Tip	Dimenzije	Cena
1	50x80	2,00
2	75x100	4,00
3	100x160	8,00
4	100x200	10,00

