

## UTIKAČI I UTIČNICE

# Ut



BANANA UTIKAČI Ø 4 mm  
BANANA UTIČNICE-BUKSNE Ø 4 mm  
BANANA-KLINK UTIKAČI  
BANANA-KLINK UTIČNICE  
BANANA-KLINK NASTAVCI  
RCA-ČINČ UTIKAČI I UTIČNICE  
RCA-ČINČ ADAPTERI  
UTIKAČI I UTIČNICE ZA AUTO RADIO  
AUDIO-VIDEO ADAPTERI  
DIN UTIKAČI I UTIČNICE  
MINI DIN UTIKAČI I UTIČNICE  
MINI DIN ADAPTERI  
SVHS KONEKTORI  
ATARI UTIKAČI  
MIKROFONSKI UTIKAČI I UTIČNICE  
SCART KONEKTORI  
UTIKAČI I UTIČNICE ZA ZVUČNIKE  
ANTENSKI UTIKAČI  
XLR KONEKTORI  
XLR ADAPTERI  
POWERCON KONEKTORI 220V 20A  
KOAKSIJALNI-DC UTIKAČI I UTIČNICE  
SPEAKON KONEKTORI  
TELEFONSKI UTIKAČI I UTIČNICE  
BNC KONEKTORI  
F KONEKTORI  
UHF-PL KONEKTORI  
MINI UHF-PL KONEKTORI  
N KONEKTORI  
TNC KONEKTORI  
TWINAX KONEKTORI  
FME KONEKTORI  
SMA KONEKTORI  
USB KONEKTORI  
MREZNI UTIKAČI I UTIČNICE  
CENTRONICS KONEKTORI  
SUB-D KONEKTORI  
AMP MIKRO KONEKTORI  
KONEKTORI DIN 41612-B (a + b)  
KONEKTORI DIN 41612-C (a + b)  
KONEKTORI DIN 61612-D (d + b + z)  
KONEKTORI DIN 41617 DL  
KONEKTORI DIN 41651  
KONEKTORI NYLON  
KONEKTORI PCB  
KONEKTORI DIP  
KONTAKTNE LETVICE

**BANANA UTIKAČI Ø 4 mm . . . . . UTBUT**

4 A 1000 V	<b>04CR</b> <b>04CN</b>	crveni crni		
<b>04</b>	Cena: 0,60			
10 A 1000 V	<b>10CR</b> <b>10CN</b>	crveni crni		
<b>10</b>	Cena: 0,80			
16 A 1000 V	<b>16CR</b> <b>16CN</b> <b>16PL</b> <b>16ZE</b> <b>16ZU</b> <b>16SI</b>	crveni crni plavi zeleni zuti sivi		
<b>16</b>	Cena: 1,50			
25 A 1000 V	<b>25CR</b> <b>25CN</b> <b>25PL</b> <b>25ZE</b> <b>25ZU</b> <b>25SI</b>	crveni crni plavi zeleni zuti sivi		
<b>25</b>	Cena: 2,50			
25 A 1500 V	<b>MCCR</b> <b>MCCN</b>	crveni crni		
<b>MC</b>	Cena: 3,00			

**BANANA UTIČNICE – BUKSNE Ø 4 mm. . . . . UTBIT**

<p>4 A      1000 V</p> <p><b>04CR</b>    crvena <b>04CN</b>    crna <b>04BE</b>    bela <b>04PL</b>    plava <b>04ZE</b>    zelena <b>04ZU</b>    zuta <b>04SI</b>    siva</p>	<p><b>04</b>      Cena: 1,00</p>		
<p>10 A      1000 V</p> <p><b>10CR</b>    crvena <b>10CN</b>    crna <b>10BE</b>    bela <b>10PL</b>    plava <b>10ZE</b>    zelena <b>10ZU</b>    zuta</p>	<p><b>10</b>      Cena: 1,50</p>		
<p>16 A      1000 V</p> <p><b>16CR</b>    crvena <b>16CN</b>    crna <b>16BE</b>    bela <b>16PL</b>    plava <b>16ZE</b>    zelena <b>16ZU</b>    zuta <b>16SI</b>    siva</p>	<p><b>16</b>      Cena: 2,20</p>		
<p>25 A      1000 V</p> <p><b>25CR</b>    crvena <b>25CN</b>    crna</p>	<p><b>25</b>      Cena: 2,00</p>		
<p>25 A      1500 V</p> <p><b>MCCR</b>    crvena <b>MCCN</b>    crna <b>MCPL</b>    plava <b>MCZE</b>    zelena <b>MCZU</b>    zuta <b>MCSI</b>    siva</p>	<p><b>MC</b>      Cena: 2,50</p>		

**BANANA-KLINK UTIKAČI. . . . . UTBA**

<p>UTIKAČ MONO 2,5</p>  <p><b>25M</b> 0,60</p>	<p>UTIKAČ STEREO 2,5</p>  <p><b>25S</b> 1,00</p>	<p>UTIKAČ MONO 3,5</p>  <p><b>35M</b> 0,50</p>	<p>UTIKAČ STEREO 3,5</p>  <p><b>35S</b> 0,60</p>
<p>UTIKAČ MONO 3,5 POZLAČEN</p>  <p><b>35MZ</b> 1,00</p>	<p>UTIKAČ STEREO 3,5 POZLAČEN</p>  <p><b>35SZ</b> 1,20</p>	<p>UTIKAČ MONO 3,5 METALNI</p>  <p><b>35MM</b> NIKL. 1,20 <b>35MMZ</b> ZLATNI 2,50</p>	<p>UTIKAČ STEREO 3,5 METALNI</p>  <p><b>35SM</b> NIKL. 1,20 <b>35SMZ</b> ZLATNI 2,50</p>
<p>UTIKAČ MONO 3,5 BOČNI</p>  <p><b>35MB</b> 0,90</p>	<p>UTIKAČ STEREO 3,5 BOČNI</p>  <p><b>35SB</b> 1,50</p>	<p>UTIKAČ MONO 6,3</p>  <p><b>63M</b> 0,90</p>	<p>UTIKAČ STEREO 6,3</p>  <p><b>63S</b> 1,20 <b>63SZ</b> POZLAČEN 2,50</p>
<p>UTIKAČ MONO 6,3 BOČNI</p>  <p><b>63MB</b> 1,80</p>	<p>UTIKAČ STEREO 6,3 BOČNI</p>  <p><b>63SB</b> 2,00</p>	<p>UTIKAČ MONO 6,3 METALNI</p>  <p><b>63MM</b> NIKL. 1,50 <b>63MMZ</b> ZLATNI 3,00</p>	<p>UTIKAČ STEREO 6,3 METALNI</p>  <p><b>63SM</b> NIKL. 1,50 <b>63SMZ</b> ZLATNI 4,00</p>
<p>UTIKAČ MONO 6,3 BOČNI - METALNI</p>  <p><b>63MBM</b> 2,50</p>	<p>UTIKAČ STEREO 6,3 BOČNI - METALNI</p>  <p><b>63SBM</b> 3,00</p>	<p>UTIKAČ MONO 6,3 PROFESIONALNI BOČNI</p>  <p><b>63MPBCR</b> CRVENI 7,00 <b>63MPBCN</b> CRNI 7,00</p>	<p>UTIKAČ MONO 6,3 PROFESIONALNI NEUTRIK</p>  <p><b>63MPN</b> 10,00</p>





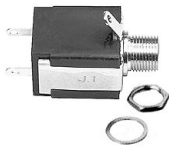













**BANANA-KLINK UTIČNICE . . . . . UTBAU**

UTIČNICA MONO 2,5  <b>25M</b> 0,70	UTIČNICA MONO 2,5 METALNA  <b>25MM</b> 1,00	UTIČNICA MONO 3,5  <b>35M</b> 0,80	UTIČNICA MONO 3,5 METALNA  <b>35MM</b> 0,90
UTIČNICA STEREO 3,5 SA PREKIDAČEM  <b>35SP</b> 0,90	UTIČNICA STEREO 3,5 SA PREKIDAČEM ZA ŠTAMPU  <b>35SS</b> 0,90	UTIČNICA 6,3  <b>63M</b> MONO 2,00 <b>63S</b> STEREO 2,00	UTIČNICA 6,3 SA PREKIDAČEM  <b>63MP</b> MONO 2,20 <b>63SP</b> STEREO 2,20
UTIČNICA 6,3 METALNA  <b>63MM</b> MONO 1,20 <b>63SM</b> STEREO 1,50	UTIČNICA 6,3 METALNA SA PREKIDAČEM  <b>63MMP</b> MONO 1,50 <b>63SMP</b> STEREO 2,00	UTIČNICA MONO 6,3 ZA ŠTAMPU  <b>63MS</b> 2,50	UTIČNICA STEREO 6,3 ZA ŠTAMPU  <b>63SS</b> 3,00

**BANANA-KLINK NASTAVCI . . . . . UTBAN**

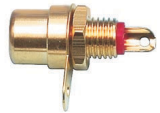



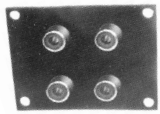
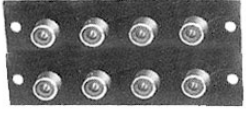



NASTAVAK 2,5  <b>25M</b> MONO 1,00 <b>25S</b> STEREO 1,20	NASTAVAK 3,5 KABLOVSKI  <b>35M</b> MONO 1,20 <b>35S</b> STEREO 1,50	NASTAVAK 3,5 KABLOVSKI METALNI  <b>35MM</b> MONO NIKL. 2,00 <b>35MMZ</b> MONO ZLATNI 3,00 <b>35SM</b> STEREO NIKL. 2,00 <b>35SMZ</b> STEREO ZLAT. 3,00	NASTAVAK 3,5 FIKSNI METALNI  <b>35SFM</b> STEREO 2,50
NASTAVAK 6,3 KABLOVSKI  <b>63M</b> MONO 1,30 <b>63S</b> STEREO 1,70	NASTAVAK 6,3 KABLOVSKI METALNI  <b>63MM</b> MONO NIKL. 3,00 <b>63MMZ</b> MONO ZLATNI 5,00 <b>63SM</b> STEREO NIKL. 3,00 <b>63SMZ</b> STEREO ZLAT. 5,00	NASTAVAK 6,3 FIKSNI  <b>63MF</b> MONO 2,50 <b>63SF</b> STEREO 2,50	NASTAVAK 6,3 FIKSNI METALNI  <b>63MFM</b> MONO 4,00 <b>63SFM</b> STEREO 4,00

**RCA-ČINČ UTIKAČI I UTIČNICE . . . . . UTCI**



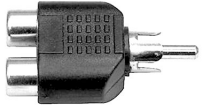





ČINČ UTIKAČ MUŠKI  <b>M-CR</b> CRVENI <b>M-CN</b> CRNI <b>M-ZU</b> ŽUTI <b>M-ZE</b> ZELENI <b>M-BE</b> BELI 0,40	ČINČ UTIKAČ MUŠKI - POZLAČEN  <b>MCRP</b> CRVENI 0,80 <b>MCNP</b> CRNI 0,80	ČINČ UTIKAČ MUŠKI - METALNI  <b>MMET</b> 1,20	ČINČ UTIKAČ MUŠKI - METALNI ZLATNI  <b>MCRZ</b> CRVENI 2,00 <b>MCNZ</b> CRNI 2,00
ČINČ UTIKAČ ZENSKI  <b>Z-CR</b> CRVENI <b>Z-CN</b> CRNI <b>Z-ZU</b> ŽUTI <b>Z-ZE</b> ZELENI <b>Z-BE</b> BELI 0,40	ČINČ UTIKAČ ZENSKI - POZLAČEN  <b>ZCRP</b> CRVENI 0,80 <b>ZCNP</b> CRNI 0,80	ČINČ UTIKAČ ZENSKI - METALNI  <b>ZMET</b> 1,50	ČINČ UTIKAČ ZENSKI - METALNI ZLATNI  <b>ZCRZ</b> CRVENI 2,50 <b>ZCNZ</b> CRNI 2,50
ČINČ UTIKAČ MUŠKI - METALNI CRIMP  <b>MMC</b> 1,00	ČINČ UTIKAČ MUŠKI - METALNI SA UVODNIKOM  <b>MMU</b> 2,00	ČINČ UTIKAČ MUŠKI - METALNI PROFESIONALNI  <b>MMPCR</b> CRVENI 8,00 <b>MMPCN</b> CRNI 8,00	ČINČ UTIKAČ ZENSKI - METALNI PROFESIONALNI  <b>ZMPCR</b> CRVENI 8,00 <b>ZMPCN</b> CRNI 8,00
ČINČ UTIČNICA ŠASIJSKA  <b>USCR</b> CRVENA 0,50 <b>USCN</b> CRNA 0,50	ČINČ UTIČNICA ŠASIJSKA - ZLATNA  <b>USCRZ</b> CRVENA 1,20 <b>USCNZ</b> CRNA 1,20	ČINČ UTIČNICA ZA ŠTAMPU  <b>USP</b> 1,50	ČINČ UTIČNICA PLOČICA  <b>UPL1CR</b> 0,50 <b>UPL1CN</b> 0,50
ČINČ UTIČNICA PLOČICA CR / CN  <b>UPL2</b> 0,80	ČINČ UTIČNICA PLOČICA 4X PRAVOUGAONA  <b>UPL4P</b> 1,50	ČINČ UTIKAČ PLOČICA 4X KOČKA  <b>UPL4K</b> 2,50	ČINČ UTIČNICA PLOČICA 8X  <b>UPL8</b> 3,00

 18000 Niš, Jovana Ristića 7, P.O.Box 135, Tel: 018 / 520-455, 522-814, 522-965, fax: 522-660  
<http://www.MGelectronic.co.yu> e-mail: [office@MGelectronic.co.yu](mailto:office@MGelectronic.co.yu)







**RCA-ČIŃ ADAPTERI . . . . . UTCIA**

ČIŃ ADAPTER MUŠKI / MUŠKI 	ČIŃ ADAPTER ZENSKI / ZENSKI 	ČIŃ ADAPTER 2X ZENSKI / 2X ZENSKI 	ČIŃ ADAPTER UGAONI 
<b>MMCR</b> CRVENI 0,80 <b>MMCN</b> CRNI 0,80	<b>ZZCR</b> CRVENI 0,80 <b>ZZCN</b> CRNI 0,80	<b>ZZ2X</b> 1,50	<b>UCR</b> CRVENI 1,50 <b>UCN</b> CRNI 1,50
ČIŃ ADAPTER MUŠKI / 2X ZENSKI 	ČIŃ ADAPTER ZENSKI / 2X ZENSKI 	ČIŃ ADAPTER RAZVODNIK 	ČIŃ ADAPTER T RAZVODNIK 
<b>M2Z</b> 1,50	<b>Z2Z</b> 1,50	<b>R</b> ZLATNI 8,00	<b>T</b> ZLATNI 7,00

**UTIKAČI I UTIČNICE ZA AUTO RADIO . . . . . UTAR**

ANTENSKI UTIKAČ 	ANTENSKI UTIKAČ 	ANTENSKI UTIKAČ KOAX. 11mm 	ANTENSKA UTIČNICA KABLOVSKA 
<b>AM</b> 0,90	<b>AM1</b> 1,50	<b>AM11</b> 4,00	<b>AZK</b> 2,00
ANTENSKA UTIČNICA ŠASIJSKA 	ANTENSKI ADAPTER UTIKAČ / UTIČNICA KOAX. 11mm 	UTIKAČ ZA AUTO UPALJAČ 	UTIČNICA ZA AUTO UPALJAČ 
<b>AZS</b> 1,50	<b>AA</b> 3,00	<b>U</b> 2,00 <b>UO</b> SA OSIGURAČEM 3,00	<b>UZ</b> 3,00

**AUDIO-VIDEO ADAPTERI. . . . . UTAA**

<p>UTIKAČ MONO 3,5 ČINČ UTIČNICA</p>  <p><b>001</b> 1,00</p>	<p>UTIKAČ MONO 3,5 UTIČNICA STEREO 3,5</p>  <p><b>002</b> 1,50</p>	<p>UTIKAČ MONO 3,5 UTIČNICA STEREO 6,3</p>  <p><b>003</b> 1,50</p>	<p>UTIKAČ MONO 3,5 UTIČNICA MONO 6,3</p>  <p><b>004</b> 1,50</p>
<p>UTIKAČ STEREO 3,5 UTIČNICA STEREO 6,3</p>  <p><b>005</b> 1,50</p>	<p>UTIKAČ MONO 6,3 UTIČNICA MONO 3,5</p>  <p><b>006</b> 1,50</p>	<p>UTIKAČ STEREO 6,3 UTIČNICA STEREO 3,5</p>  <p><b>007</b> 1,50</p>	<p>ČINČ UTIKAČ UTIČNICA MONO 3,5</p>  <p><b>008</b> 1,50</p>
<p>UTIKAČ MONO 3,5 ČINČ UTIČNICA 2 X</p>  <p><b>009</b> 1,50</p>	<p>UTIKAČ STEREO 3,5 ČINČ UTIČNICA 2 X</p>  <p><b>010</b> 1,50</p>	<p>UTIKAČ STEREO 6,3 ČINČ UTIČNICA 2X</p>  <p><b>011</b> 2,00</p>	<p>UTIKAČ STEREO 3,5 2 X UTIČNICA STEREO 3,5</p>  <p><b>012</b> 2,00</p>
<p>UTIKAČ STEREO 3,5 2 X UTIČNICA STEREO 6,3</p>  <p><b>013</b> 2,00</p>	<p>UTIKAČ STEREO 6,3 2 X UTIČNICA STEREO 3,5</p>  <p><b>014</b> 2,00</p>	<p>UTIKAČ STEREO 6,3 2 X UTIČNICA STEREO 6,3</p>  <p><b>015</b> 2,00</p>	<p>UTIKAČ MONO 3,5 COAX. UTIČNICA</p>  <p><b>017</b> 1,50</p>
<p>UTIKAČ STEREO 2,5 UTIČNICA STEREO 3,5</p>  <p><b>018</b> 2,00</p>	<p>ČINČ UTIKAČ COAX. UTIČNICA</p>  <p><b>019</b> 2,00</p>	<p>ČINČ UTIČNICA COAX. UTIKAČ</p>  <p><b>020</b> 1,20</p>	<p>UTIKAČ MONO 6,3 ČINČ UTIČNICA</p>  <p><b>021</b> 1,20</p>
<p>UTIKAČ STEREO 6,3 UTIČNICA MONO 3,5</p>  <p><b>022</b> 1,50</p>	<p>UTIKAČ MONO 3,5 UTIČNICA MONO 2,5</p>  <p><b>023</b> 1,80</p>	<p>UTIKAČ MONO 2,5 UTIČNICA MONO 3,5</p>  <p><b>024</b> 1,50</p>	<p>UTIKAČ STEREO 3,5 UTIČNICA STEREO 2,5</p>  <p><b>025</b> 1,20</p>

18000 Niš, Jovana Ristića 7, P.O.Box 135, Tel: 018 / 520-455, 522-814, 522-965, fax: 522-660  
<http://www.MGelectronic.co.yu> e-mail: [office@MGelectronic.co.yu](mailto:office@MGelectronic.co.yu)



**AUDIO-VIDEO ADAPTERI. . . . . UTAA**

ČINČ UTIKAČ UTIČNICA MONO 6,3 	UTIKAČ MONO 6,3 UTIČNICA STEREO 6,3 	UTIKAČ MONO 6,3 COAX. UTIKAČ 	UTIKAČ MONO 6,3 COAX. UTIČNICA 
<b>026</b> 2,00	<b>030</b> 1,50	<b>031</b> 2,50	<b>032</b> 2,50
UTIKAČ MONO 6,3 UTIKAČ MONO 6,3 	UTIKAČ MONO 6,3 UTIKAČ MONO 6,3 	UTIKAČ MONO 6,3 UTIČNICA MONO 6,3 90° 	UTIKAČ MONO 6,3 ČINČ UTIČNICA 2 x 
<b>033</b> 3,00	<b>034</b> 4,00	<b>035</b> 6,00	<b>036</b> 2,00
UTIKAČ MONO 6,3 2 x UTIČNICA MONO 6,3 	UTIKAČ MONO 6,3 2 x UTIČNICA MONO 3,5 	UTIKAČ STEREO 6,3 UTIČNICA MONO 6,3 	UTIKAČ STEREO 6,3 UTIKAČ STEREO 6,3 
<b>037</b> 2,00	<b>038</b> 2,00	<b>040</b> 2,00	<b>041</b> 4,00
UTIKAČ MONO 3,5 COAX. UTIKAČ 	UTIKAČ MONO 3,5 2 x UTIČNICA MONO 3,5 	UTIKAČ STEREO 3,5 UTIČNICA MONO 6,3 	UTIKAČ STEREO 3,5 UTIČNICA MONO 6,3 
<b>043</b> 1,50	<b>044</b> 1,80	<b>045</b> 1,00	<b>046</b> 1,20
UTIKAČ MONO 2,5 UTIČNICA STEREO 3,5 	UTIKAČ MONO 2,5 ČINČ UTIČNICA 	ČINČ UTIKAČ UTIČNICA STEREO 6,3 	ČINČ UTIKAČ UTIČNICA STEREO 3,5 
<b>048</b> 1,50	<b>049</b> 1,20	<b>050</b> 1,60	<b>051</b> 1,50
ČINČ UTIKAČ 2 x UTIČNICA MONO 6,3 	ČINČ UTIKAČ 2 x UTIČNICA MONO 3,5 	OPTIČKI ADAPTER TOSLINK - 3,5 	OPTIČKI ADAPTER TOSLINK - TOSLINK 
<b>052</b> 3,00	<b>053</b> 2,00	<b>062</b> 5,00	<b>063</b> 6,00

# UTIKAČI I UTIČNICE

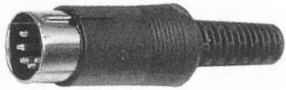

UT

## DIN UTIKAČI I UTIČNICE . . . . . UTDIN

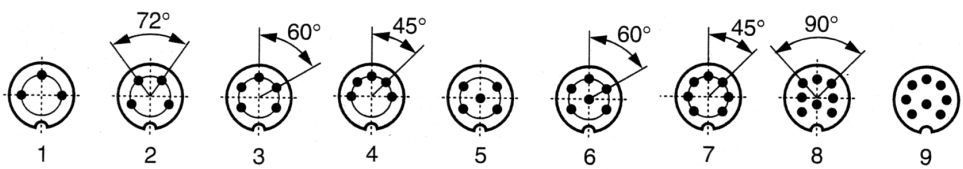
UTIKAČI MUŠKI	UTDINM	UTIKAČI ZENSKI	UTDINZ	UTIČNICE	UTDINU
					
1 3-POLNI 180° . . 1,80		1 3-POLNI 180° . . 1,80		1 3-POLNA 180° . . 1,80	
2 4-POLNI 216° . . 1,80		2 4-POLNI 216° . . 1,80		2 4-POLNA 216° . . 1,80	
3 5-POLNI 240° . . 1,90		3 5-POLNI 240° . . 1,90		3 5-POLNA 240° . . 1,90	
4 5-POLNI 180° . . 1,80		4 5-POLNI 180° . . 1,90		4 5-POLNA 180° . . 1,90	
5 (4+1)-POLNI 360° . . 1,80		5 (4+1)-POLNI 360° . . 2,00		5 (4+1)-POLNA 360° . . 2,00	
6 (5+1)-POLNI 240° . . 2,00		6 (5+1)-POLNI 240° . . 2,20		6 (5+1)-POLNA 240° . . 2,20	
7 7-POLNI 270° . . 2,20		7 7-POLNI 270° . . 2,40		7 7-POLNA 270° . . 2,40	
8 (7+1)-POLNI 262° . . 2,40		8 (7+1)-POLNI 262° . . 2,40		8 (7+1)-POLNA 262° . . 2,60	
9 (7+1)-POLNI 270° . . 2,40		9 (7+1)-POLNI 270° . . 2,40		9 (7+1)-POLNA 270° . . 2,80	

## MINI DIN UTIKAČI I UTIČNICE . . . . . UTM DIN

UTIKAČI MUŠKI	UTMDINM	UTIKAČI ZENSKI	UTMDINZ	UTIČNICE	UTMDINU
					
3 3-POLNI 240° . 2,50		3 3-POLNI 240° . 2,80		3 3-POLNA 240° . . 2,80	
4 4-POLNI 180° . 2,50		4 4-POLNI 180° . 2,80		4 4-POLNA 180° . . 2,80	
5 5-POLNI 360° . 2,50		5 5-POLNI 360° . 3,00		5 5-POLNA 360° . . 3,00	
6 6-POLNI 240° . 2,80		6 6-POLNI 240° . 3,00		6 6-POLNA 240° . . 3,20	
7 7-POLNI 270° . 2,80		7 7-POLNI 270° . 3,50		7 7-POLNA 270° . . 3,50	
8 8-POLNI 262° . 2,80		8 8-POLNI 262° . 3,50		8 8-POLNA 262° . . 3,50	

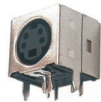
18000 Niš, Jovana Ristića 7, P.O.Box 135, Tel: 018 / 520-455, 522-814, 522-965, fax: 522-660  
<http://www.MGelectronic.co.yu> e-mail: [office@MGelectronic.co.yu](mailto:office@MGelectronic.co.yu)

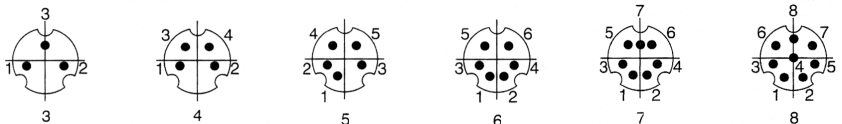





## UTIKAČI I UTIČNICE

UT

### MINI DIN ADAPTERI . . . . . UTMDINA

<p>DIN 4 MUŠKI MDIN 6 ZENSKI (PS2)</p>  <p>1 3,00</p>	<p>DIN 4 ZENSKI MDIN 6 MUŠKI (PS2)</p>  <p>2 3,00</p>	<p>MDIN 6 ZENSKI (PS2) MDIN 6 ZENSKI (PS2)</p>  <p>3 3,00</p>	<p>MDIN 6 MUŠKI (PS2) 2 x MDIN 6 ZENSKI (PS2)</p>  <p>4 4,00</p>
--	--	---	---









### SVHS KONEKTORI . . . . . UTSVHS

<p>SVHS UTIKAČ</p>  <p>U 2,50</p>	<p>SVHS NASTAVAK</p>  <p>N 4,00</p>	<p>SVHS - 2xČINČ ZENSKI</p>  <p>A 6,00</p>	<p>UTIKAČ SVHS ČINČ ZENSKI</p>  <p>C 4,00</p>
--	--	--	--

### ATARI UTIKAČI . . . . . UTAT

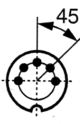

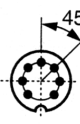



<p>DIN UTIKAČI -ATARI</p> <p>13 13-POLNI . . . 4,00 14 14-POLNI . . . 8,00</p> 
--

### MIKROFONSKI UTIKAČI I UTIČNICE . . . . . UTM

UTIKAČI MUŠKI	UTMIM	UTIKAČI ZENSKI	UTMIZ	UTIČNICE	UTMIU
					
3 3-POLNI . . . 8,00		3 3-POLNI . . . 4,00		3 3-POLNA . . . 4,00	
4 4-POLNI . . . 8,00		4 4-POLNI . . . 4,00		4 4-POLNA . . . 4,00	
5 5-POLNI . . . 9,00		5 5-POLNI . . . 5,00		5 5-POLNA . . . 5,00	
6 6-POLNI . . . 9,00		6 6-POLNI . . . 6,00		6 6-POLNA . . . 6,00	
7 7-POLNI . . . 9,00		7 7-POLNI . . . 6,00		7 7-POLNA . . . 6,00	
8 8-POLNI . . . 12,00		8 8-POLNI . . . 6,00		8 8-POLNA . . . 6,00	
					
3	4	5	6	7	8



**SCART KONEKTORI . . . . . UTSCA**

UTIKAČ SCART KABLOVSKI MUŠKI  <b>KM</b> 1,50	UTIKAČ SCART KABLOVSKI ZENSKI  <b>KZ</b> 3,00	UTIČNICA SCART ŠASIJSKA ZENSKA  <b>US</b> 1,50	UTIČNICA SCART ZENSKA – PCB  <b>UPCB</b> 1,50
ADAPTER SCART / DIN 6 PLAY-RECORD  <b>A18</b> 4,00	ADAPTER SCART/ 3 x ČINČ AUDIO – VIDEO IN  <b>A50</b> 4,00	ADAPTER SCART / 3 x ČINČ AUDIO – VIDEO OUT  <b>A51</b> 4,00	ADAPTER SCART / 2x ČINČ AUDIO IN  <b>A52</b> 3,00
ADAPTER SCART / 2 x ČINČ AUDIO OUT  <b>A53</b> 3,00	ADAPTER SCART / 3x ČINČ AUDIO – VIDEO OUT / IN  <b>A54</b> 5,00	ADAPTER SCART / 3x ČINČ + SVHS AUDIO – VIDEO OUT / IN  <b>A56</b> 8,00	ADAPTER SCART M + Z + 3x ČINČ + SVHS AUDIO – VIDEO OUT / IN  <b>A60</b> 12,00

**UTIKAČI I UTIČNICE ZA ZVUČNIKE . . . . . UTZV**

UTIKAČ MUŠKI KABLOVSKI  <b>MK</b> 0,80	UTIKAČ MUŠKI KABLOVSKI – BOČNI  <b>MKB</b> 0,90	UTIKAČ MUŠKI KABLOVSKI – MINI  <b>MKMCR</b> 1,20 <b>MKMCN</b> 1,20	UTIKAČ ZENSKI KABLOVSKI  <b>ZK</b> 0,90
UTIČNICA ZENSKA ŠASIJSKA  <b>ZS</b> 0,70	UTIČNICA ZENSKA ZA ŠTAMPANU PLOČU  <b>ZSS</b> 1,20	TERMINALI SA NAVOJEM  <b>T1CR</b> crveni 1,20 <b>T1CN</b> crni 1,20	TERMINALI CRIMP  <b>T2</b> 2,5 mm 1,00 <b>T4</b> 4,0 mm 1,20 <b>T6</b> 6,0 mm 1,50

**ANTENSKI UTIKAČI . . . . . UTANT**

UTIKAČ KABLOVSKI MUŠKI  <b>KM</b> 0,50	UTIKAČ KABLOVSKI MUŠKI - BOČNI  <b>KMB</b> 0,50	UTIKAČ KABLOVSKI MUŠKI METALNI  <b>KMM</b> 1,20	UTIKAČ KABLOVSKI MUŠKI PROFESIONALNI  <b>KMP</b> 3,00
UTIKAČ KABLOVSKI ZENSKI  <b>KZ</b> 0,50	UTIKAČ KABLOVSKI ZENSKI BOČNI  <b>KZB</b> 0,50	UTIKAČ KABLOVSKI ZENSKI METALNI  <b>KZM</b> 1,20	UTIKAČ KABLOVSKI ZENSKI PROFESIONALNI  <b>KZP</b> 3,00
UTIČNICA ŠASIJSKA MUŠKA  <b>SM</b> 1,50	UTIČNICA ŠASIJSKA ZENSKA  <b>SZ</b> 1,50	UTIČNICA ŠASIJSKA ZENSKA - PRINT  <b>SZPR</b> 1,20	UTIČNICA ŠASIJSKA ZENSKA PANEL  <b>SZPA</b> 1,00
NASTAVAK ZENSKI / ZENSKI  <b>NZZ</b> 1,20	NASTAVAK MUŠKI / MUŠKI  <b>NMM</b> 0,80	NASTAVAK MUŠKI / ZENSKI  <b>NMZ</b> 0,80	NASTAVAK FIKSNI  <b>NF</b> 0,80
RAZVODNIK ZENSKI / 2X MUŠKI  <b>RAZ1</b> 2,00	RAZVODNIK MUŠKI / 2X ZENSKI  <b>RAZ2</b> 2,00	RAZVODNIK MUŠKI / 2X ZENSKI  <b>RAZ3</b> 1,50	RAZVODNIK ZENSKI / 2X MUŠKI  <b>RAZ4</b> 1,50
UTIKAČ KABLOVSKI MUŠKI-FR  <b>FKM</b> 2,00	UTIKAČ KABLOVSKI ZENSKI-FR  <b>FKZ</b> 2,00	ADAPTER-FR 9 mm / 9,5 mm  <b>FAD</b> 3,00	RAZVODNIK-FR MUŠKI / 2X ZENSKI  <b>FRAZ</b> 3,00

**XLR KONEKTORI. . . . . UTXLR**

**Tehnički podaci**

Izolacioni materijal:	poliamid
Kućište:	niklovani čelik
Kontakti:	1,5 mm <sup>2</sup> , 0,5 μ zlato na niklu
Radni napon:	250 V AC
Ispitni napon:	1500 V AC
Struja:	16 A (3-polni) 7,5 A (5-polni)
Otpor izolacije:	>10 <sup>9</sup> Ω
Prolazni otpor:	≤ 3 MΩ
Radna temperatura:	-40... +80°C

**KABLOVSKI . . . . . UTXLRK**

	Tip	Pol	Cena
<b>Muški</b>	<b>M3</b>	3	3,00
	<b>M4</b>	4	4,00
	<b>M5</b>	5	5,00
<b>enski</b>	<b>Z3</b>	3	3,00
	<b>Z4</b>	4	4,00
	<b>Z5</b>	5	5,00

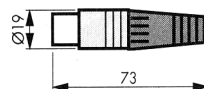
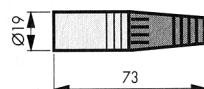

**ŠASIJSKI . . . . . UTXLRS**

	Tip	Pol	Cena
<b>Muški</b>	<b>M3</b>	3	3,00
	<b>M4</b>	4	4,00
	<b>M5</b>	5	5,00
<b>enski</b>	<b>Z3</b>	3	3,00
	<b>Z4</b>	4	4,00
	<b>Z5</b>	5	5,00

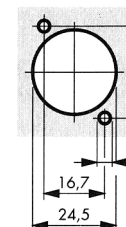
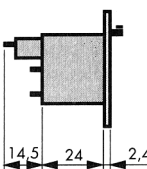
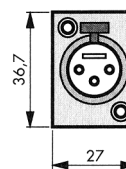
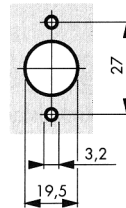
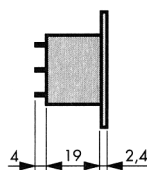
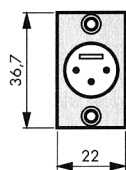

**XLR ADAPTERI . . . . . UTXLRA**

<p>3 POL. ZENSKI 3 POL. ZENSKI</p>  <p><b>ZZ</b> 6,00</p>	<p>3 POL. ZENSKI 3 POL. MUŠKI</p>  <p><b>ZM</b> 8,00</p>	<p>3 POL. MUŠKI 3 POL. MUŠKI</p>  <p><b>MM</b> 6,00</p>	<p>3 POL. MUŠKI UTIČNICA 6,3 STEREO</p>  <p><b>M63Z</b> 8,00</p>
<p>3 POL. ZENSKI UTIKAČ 6,3 MONO</p>  <p><b>Z63M</b> 6,00</p>	<p>3 POL. ZENSKI UTIKAČ 6,3 STEREO</p>  <p><b>Z63S</b> 6,00</p>	<p>3 POL. MUŠKI UTIKAČ 6,3 MONO</p>  <p><b>M63M</b> 6,00</p>	<p>3 POL. MUŠKI UTIKAČ 6,3 STEREO</p>  <p><b>M63S</b> 6,00</p>
<p>3 POL. ZENSKI ČINČ UTIKAČ</p>  <p><b>ZCM</b> 6,00</p>	<p>3 POL. ZENSKI ČINČ UTIČNICA</p>  <p><b>ZCZ</b> 6,00</p>	<p>3 POL. MUŠKI ČINČ UTIKAČ</p>  <p><b>MCM</b> 6,00</p>	<p>3 POL. MUŠKI ČINČ UTIČNICA</p>  <p><b>MCZ</b> 6,00</p>

**POWERCON KONEKTORI 220V 20A . . . . . UTPC**

<p>POWERCON UTIKAČ KABL. - ULAZ</p>  <p><b>KU</b> 18,00</p>	<p>POWERCON UTIČNICA ŠASIJSKI - ULAZ</p>  <p><b>SU</b> 9,00</p>	<p>POWERCON UTIKAČ KABL. - IZLAZ</p>  <p><b>KI</b> 18,00</p>	<p>POWERCON UTIČNICA ŠASIJSKI - IZLAZ</p>  <p><b>SI</b> 9,00</p>
--	--	--	---

**KOAKSIJALNI-DC UTIKAČI I UTIČNICE . . . . . UTDC**



UTIKAČ KABLOVSKI 1,3 X 3,4 X 9,5  1,3 0,80	UTIKAČ KABLOVSKI 1,3 X 3,4 X 14  1,3-14 0,80	UTIKAČ KABLOVSKI 2,1 X 5,5 X 9,5  2,1 0,80	UTIKAČ KABLOVSKI 2,1 X 5,5 X 14  2,1-14 0,80
UTIKAČ KABLOVSKI 2,5 X 5,5 X 9,5  2,5 0,80	UTIKAČ KABLOVSKI 2,5 X 5,5 X 14  2,5-14 0,80	UTIKAČ KABLOVSKI 3,1 X 6,3 X 9,5  3,1 0,80	UTIKAČ KABLOVSKI BOČNI  B2,1 2,50
UTIKAČ KABLOVSKI ZENSKI  KA2,1 3,50	UTIČNICA ŠASIJSKA ZENSKA - PANEL  PA2,1 0,80 PA2,5 0,80	UTIČNICA ŠASIJSKA ZENSKA - PRINT  PR2,1 0,80 PR2,5 0,80	UTIČNICA ŠASIJSKA ZENSKA - NAVOJ  NA2,1 3,00 NA2,5 3,00

**SPEAKON KONEKTORI . . . . . UTSP**

SPEAKON UTIKAČ KABLOVSKI MUŠKI  KM2 2 POL 6,00 KM4 4 POL 8,00 KM8 8 POL 14,00	SPEAKON UTIKAČ KABLOVSKI ZENSKI  KZ 4 POL 8,00	SPEAKON UTIČNICA ŠASIJSKA KVADRATNA MANJA 30x35  SKM 4POL 4,00
UTIČNICA ŠASIJSKA KVADRATNA VEĆA 40x40  SKV 4 POL 4,00	SPEAKON UTIČNICA ŠASIJSKA OKRUGLA $\phi$ 50  SO 4 POL 4,00	SPEAKON ADAPTER NASTAVAK  N 4 POL 8,00

 18000 Niš, Jovana Ristića 7, P.O.Box 135, Tel: 018 / 520-455, 522-814, 522-965, fax: 522-660  
<http://www.MGelectronic.co.yu> e-mail: [office@MGelectronic.co.yu](mailto:office@MGelectronic.co.yu)

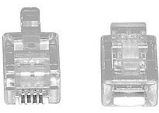
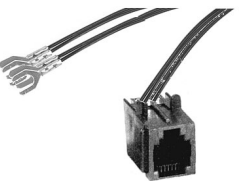
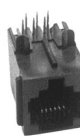
**TELEFONSKI UTIKAČI I UTIČNICE . . . . . UTTEL**

UTIKAČ RJ 9  <b>002</b> 4/4     0,20	UTIKAČ RJ 11  <b>004</b> 6/4     0,25	UTIKAČ RJ 12  <b>006</b> 6/6     0,30	UTIKAČ RJ 45  <b>008</b> 8/8     0,80
UTIČNICA 6/4 SA UŠICAMA  <b>009</b> 1,20	UTIČNICA RJ 9 PRINT  <b>04</b> 4/4     1,20	UTIČNICA RJ 12 PRINT  <b>06</b> 6/6     1,40	UTIČNICA RJ 45 PRINT  <b>08</b> 8/8     1,80
UTIČNICA - KUTIJA 1 x RJ 11  <b>010</b> 2,50	UTIČNICA - KUTIJA 2 x RJ 11  <b>010/2</b> 3,50	UTIČNICA - PANEL 2 x RJ 11  <b>011</b> 4,00	UTIČNICA - ZIDNA  <b>012</b> 3,50
NASTAVAK 2 x UTIČNICA 6/4  <b>013</b> 1,50	RAZVODNIK UTIKAČ 6/4 2 x UTIČNICA 6/4  <b>014</b> 2,50	RAZVODNIK UTIKAČ 6/4 UTIČNICE 6/4 i 4/8  <b>015</b> 3,00	RAZVODNIK UTIČNICA 6/4 2 x UTIČNICA 6/4  <b>016</b> 2,50
NASTAVAK 2 x UTIČNICA 8/8  <b>017</b> ISDN     2,00	RAZVODNIK UTIČNICA 8/8 2 x UTIČNICA 8/8  <b>018</b> ISDN     3,00	UTIKAČ, STANDARD  <b>S</b> 1,80	UTIKAČ STANDARD ADAPTER 6/4  <b>SA</b> 3,20





**BNC KONEKTORI . . . . . UTBNC**

<p>BNC UTIKAČ</p>  <p>UG 88 50Ω 2,50 UG 260 75Ω 2,50</p>	<p>BNC UTIKAČ CRIMP</p>  <p>UG 88C 50Ω 1,50 UG 260C 75Ω 1,50</p>	<p>BNC UTIKAČ TWIST-ON</p>  <p>UG 88T 50Ω 2,00 UG 260T 75Ω 2,00</p>	<p>BNC UTIKAČ 90°</p>  <p>UG 260U 3,00</p>
<p>BNC UTIČNICA KABL.</p>  <p>UG 261 3,00</p>	<p>BNC UTIČNICA KABL. CRIMP</p>  <p>UG 261C 3,00</p>	<p>BNC UTIČNICA KABL. TWIST-ON</p>  <p>UG 261T 2,50</p>	<p>BNC UTIČNICA KABL. 90°</p>  <p>UG 261U 3,00</p>
<p>BNC UTIKAČ TWIST-ON 90°</p>  <p>UG 260TU 6,00</p>	<p>BNC UTIČNICA PANEL</p>  <p>UG 290 2,50</p>	<p>BNC UTIČNICA PANEL</p>  <p>UG 1094 2,00</p>	<p>BNC UTIKAČ PANEL IZOLOVANA</p>  <p>UG1094I 5,00</p>
<p>BNC UTIČNICA PANEL KABLOVSKA</p>  <p>UG1094K 3,00</p>	<p>BNC UTIČNICA PANEL KABLOVSKA CRIMP</p>  <p>UG1094C 6,00</p>	<p>BNC UTIČNICA PANEL, DVOSTRUKA</p>  <p>UG1094D 8,00</p>	<p>BNC UTIČNICA PRINT</p>  <p>UG1094P 5,00</p>
<p>BNC UTIČNICA PRINT IZOLOVANA VERTIKAL.</p>  <p>UG1094PV 5,00</p>	<p>BNC UTIČNICA PRINT IZOLOVANA HORIZ.</p>  <p>UG1094PH 5,00</p>	<p>BNC ZAVRŠETAK TERMINATOR</p>  <p>UG 88 / 50 2,00 UG 88 / 75 2,00 UG 88 / 93 3,00</p>	<p>BNC T ADAPTER</p>  <p>UG 274 2,50</p>

18000 Niš, Jovana Ristića 7, P.O.Box 135, Tel: 018 / 520-455, 522-814, 522-965, fax: 522-660  
<http://www.MGelectronic.co.yu> e-mail: [office@MGelectronic.co.yu](mailto:office@MGelectronic.co.yu)



**BNC KONEKTORI . . . . . UTBNC**

















<p>BNC L ADAPTER</p>  <p><b>UG 306U</b> 6,00 <b>Y</b></p>	<p>BNC Y ADAPTER</p>  <p>8,00</p>	<p>BNC NASTAVAK 2 x UTIKAČ</p>  <p><b>UG 491</b> 5,00</p>	<p>BNC NASTAVAK 2 x UTIČNICA</p>  <p><b>UG 914</b> 1,50</p>
<p>BNC UTIČNICA ČINČ UTIKAČ</p>  <p><b>201</b> 2,00</p>	<p>BNC UTIKAČ ČINČ UTIČNICA</p>  <p><b>202</b> 1,50</p>	<p>BNC UTIKAČ ČINČ UTIKAČ</p>  <p><b>401</b> 3,00</p>	<p>BNC UTIČNICA ČINČ UTIČNICA</p>  <p><b>404</b> 5,00</p>
<p>BNC UTIKAČ UHF UTIKAČ</p>  <p><b>411</b> 8,00</p>	<p>BNC UTIKAČ UHF UTIČNICA</p>  <p><b>412</b> 6,00</p>	<p>BNC UTIČNICA UHF UTIČNICA</p>  <p><b>414</b> 8,00</p>	<p>BNC UTIKAČ F UTIKAČ</p>  <p><b>421</b> 7,00</p>
<p>BNC UTIČNICA F UTIČNICA</p>  <p><b>424</b> 5,00</p>	<p>BNC UTIKAČ ANTENSKI UTIKAČ</p>  <p><b>431</b> 5,00</p>	<p>BNC UTIKAČ ANTENSKA UTIČNICA</p>  <p><b>432</b> 5,00</p>	<p>BNC UTIČNICA ANTENSKI UTIKAČ</p>  <p><b>433</b> 5,00</p>
<p>BNC UTIČNICA ANTENSKA UTIČNICA</p>  <p><b>434</b> 5,00</p>	<p>BNC UTIČNICA 2 x UTIKAČ <math>\phi 4</math></p>  <p><b>123</b> 10,00</p>	<p>BNC UTIKAČ UTIČNICA <math>\phi 4</math></p>  <p><b>125</b> 6,00</p>	<p>BNC UTIKAČ 2 x BUKSNA <math>\phi 4</math></p>  <p><b>UG 860</b> 12,00</p>

**F KONEKTORI . . . . . UTFC**

F UTIKAČ  001/RG58 0,40 001/RG59 0,40 001/RG213 1,50	F NASTAVAK KABLOVSKI  002 0,50	F UTIKAČ CRIMP  004 0,60	F BRZI UTIKAČ 90°  005 2,00
F UTIČNICA PANEL-FRONT  014 0,70	F UTIČNICA PANEL  015 1,00	F UTIČNICA PCB VERTIKALNA  016 1,50	F UTIČNICA PCB HORIZONTALNA  017 2,80
F NASTAVAK PANEL  018 0,50	F UTIKAČ F UTIKAČ  019 1,50	F UTIČNICA F UTIKAČ 90°  020 1,60	F ZAVRŠETAK TERMINATOR  021 0,60
F UTIČNICA BNC UTIKAČ  022 2,00	F UTIKAČ BNC UTIČNICA  023 1,60	F UTIČNICA ČINČ UTIKAČ  024 1,50	F UTIČNICA ANTENSKI UTIKAČ  025 1,00
F UTIKAČ ANTENSKA UTIČNICA  026 2,00	F UTIČNICA BRZI F UTIKAČ  027 1,20	F UTIČNICA ANTENSKA UTIČNICA  028 1,50	F UTIKAČ ANTENSKI UTIKAČ  029 1,60
RAZVODNIK 3xF UTIČNICA  030 3,00	F UTIKAČ ČINČ UTIKAČ  031 3,00	F UTIKAČ ČINČ UTIČNICA  032 3,00	F UTIČNICA ČINČ UTIČNICA  033 3,00

 18000 Niš, Jovana Ristića 7, P.O.Box 135, Tel: 018 / 520-455, 522-814, 522-965, fax: 522-660  
<http://www.MGelectronic.co.yu> e-mail: office@MGelectronic.co.yu







**UHF-PL KONEKTORI . . . . . UTUHF**

UHF UTIKAČ  PL 259/58 2,50 PL 259/59 2,50 PL 259/213 2,50	REDUCIR-UVODNIK  004 RG 58 0,80 005 RG 59 0,80	UHF UTIČNICA PANEL  UG 266 2,50	UHF UTIČNICA PANEL  SO 239 2,50
UHF ADAPTER NASTAVAK  PL 258 2,50	UHF T ADAPTER UTIČNICA / 2X UTIČNICA  PL 258-3 6,00	UHF ADAPTER 2 X UTIKAČ  PL 259-2 4,00	UHF T ADAPTER UTIKAČ / 2 X UTIČNICA  M 358 6,00
UHF L ADAPTER UTIKAČ / UTIČNICA  M 359 5,00	UHF UTIČNICA ČINČ UTIKAČ  203 4,00	UHF UTIKAČ BNC UTIČNICA  303 4,00	UHF UTIKAČ ČINČ UTIČNICA  305 2,50
UHF UTIČNICA BNC UTIKAČ  461 8,00	UHF UTIKAČ F UTIČNICA  462 6,00	UHF UTIČNICA F UTIKAČ  463 6,00	UHF UTIČNICA F UTIČNICA  464 6,00

**MINI UHF-PL KONEKTORI . . . . . UTMUHF**

MINI UHF UTIKAČ CRIMP  KC 3,00	MINI UHF UTIČNICA KABLOVSKA CRIMP  UK 3,00	MINI UHF UTIČNICA PANEL  UP 4,00	MINI UHF ADAPTER NASTAVAK  NZZ 8,00 NMM 8,00
--	--	---	---













**N KONEKTORI. . . . . UTNC**

N UTIKAČ KABLOVSKI RG58  <b>001</b> 6,00	N UTIKAČ KABLOVSKI RG213  <b>002</b> 6,00	N UTIČNICA KABLOVSKA RG58  <b>101</b> 7,00	N UTIČNICA KABLOVSKA RG213  <b>102</b> UG23 7,00
N UTIKAČ 90° KABLOVSKI RG213  <b>103</b> 9,00	N UTIČNICA  <b>201</b> UG680U 5,00	N UTIČNICA PANEL  <b>202</b> 5,00	N UTIČNICA ŠASIJSKA  <b>203</b> 8,00
NASTAVAK 2 x N UTIKAČ  <b>300</b> UG57U 9,00	NASTAVAK 2 x N UTIČNICA  <b>301</b> UG29 6,00	N UTIKAČ BNC UTIČNICA  <b>302</b> 6,00	N UTIKAČ F UTIČNICA  <b>303</b> 6,00
N UTIKAČ UHF UTIČNICA  <b>304</b> 6,00	N UTIČNICA UHF UTIKAČ  <b>305</b> 6,00	N UTIKAČ N UTIČNICA 90°  <b>306</b> UG27U 14,00	N UTIKAČ 2 x N UTIKAČ  <b>307</b> UG107U 14,00
N UTIKAČ BNC UTIKAČ  <b>441</b> 12,00	N UTIČNICA BNC UTIČNICA  <b>442</b> 12,00	N UTIČNICA BNC UTIČNICA  <b>444</b> 9,00	N UTIKAČ UHF UTIKAČ  <b>451</b> 10,00
N UTIČNICA UHF UTIČNICA  <b>454</b> 9,00	N UTIKAČ F UTIKAČ  <b>471</b> 9,00	N UTIČNICA F UTIKAČ  <b>473</b> 9,00	N UTIČNICA F UTIČNICA  <b>474</b> 9,00

 18000 Niš, Jovana Ristića 7, P.O.Box 135, Tel: 018 / 520-455, 522-814, 522-965, fax: 522-660  
<http://www.MGelectronic.co.yu> e-mail: office@MGelectronic.co.yu



**TNC KONEKTORI . . . . . UTTNC**

<p>TNC UTIKAČ CRIMP KABL. CRIMP</p>  <p><b>001</b>    RG 58    2,00</p>	<p>TNC UTIKAČ KABLOVSKI</p>  <p><b>002</b>    RG 58    2,50</p>	<p>TNC UTIČNICA KABL. CRIMP</p>  <p><b>101</b>    RG 58    2,50</p>	<p>TNC UTIČNICA KABLOVSKA</p>  <p><b>102</b>    RG 58    2,50</p>
<p>TNC UTIČNICA PANEL</p>  <p><b>201</b>                    3,00</p>	<p>TNC NASTAVAK UTIKAČ / UTIKAČ</p>  <p><b>300</b>                    8,00</p>	<p>TNC NASTAVAK UTIČNICA / UT IČNICA</p>  <p><b>301</b>                    2,50</p>	<p>TNC UTIKAČ BNC UTIČNICA</p>  <p><b>302</b>                    3,00</p>
<p>TNC UTIKAČ ČINČ UTIČNICA</p>  <p><b>303</b>                    2,50</p>	<p>TNC T ADAPTER UTIKAČ / 2X UTIČNICA</p>  <p><b>304</b>                    8,00</p>	<p>TNC UTIKAČ UHF PL UTIČNICA</p>  <p><b>305</b>                    8,00</p>	<p>TNC UTIČNICA BNC UTIKAČ</p>  <p><b>306</b>                    8,00</p>













**TWINAX KONEKTORI . . . . . UTTWC**

<p>TWINAX UTIKAČ RG 2/22</p>  <p><b>001</b>                    6,00</p>	<p>TWINAX TERMINATOR 105Ω</p>  <p><b>002</b>                    9,00</p>	<p>TWINAX UTIČNICA KABL</p>  <p><b>101</b>                    9,00</p>	<p>TWINAX UTIČNICA PANEL</p>  <p><b>201</b>                    7,00</p>
<p>TWINAX I ADAPTER NASTAVAK</p>  <p><b>301</b>                    6,00</p>	<p>TWINAX L ADAPTER UTIKAČ / UTIČNICA</p>  <p><b>302</b>                    16,00</p>	<p>TWINAX T ADAPTER UTIKAČ / 2 X UTIČNICA</p>  <p><b>303</b>                    14,00</p>	<p>TWINAX T ADAPTER UTIČNICA 3 X</p>  <p><b>304</b>                    15,00</p>







**FME KONEKTORI . . . . . UTFME**

<p>UTIKAČ, KABLOVSKI CRIMP</p>  <p><b>00</b> 4,00</p>	<p>UTIČNICA, KABLOVSKA CRIMP</p>  <p><b>01</b> 4,00</p>	<p>FME UTIKAČ F UTIKAČ</p>  <p><b>02</b> 8,00</p>
<p>FME UTIKAČ TNC UTIKAČ</p>  <p><b>03</b> 8,00</p>	<p>NASTAVAK 2 x FME UTIKAČ</p>  <p><b>04</b> 4,00</p>	<p>FME UTIKAČ TNC UTIKAČ 90°</p>  <p><b>05</b> 9,00</p>
<p>FME UTIKAČ PANEL</p>  <p><b>06</b> 8,00</p>	<p>FME UTIKAČ BNC UTIKAČ</p>  <p><b>07</b> 5,00</p>	<p>FME UTIKAČ SMA UTIČNICA</p>  <p><b>08</b> 10,00</p>
<p>FME UTIKAČ UHF UTIKAČ</p>  <p><b>09</b> 12,00</p>	<p>FME UTIKAČ N UTIKAČ</p>  <p><b>10</b> 14,00</p>	<p>FME UTIKAČ BNC UTIČNICA</p>  <p><b>11</b> 8,00</p>

**SMA KONEKTORI . . . . . UT SMA**

<p>SMA UTIKAČ CRIMP</p>  <p><b>01</b> 7,00</p>	<p>SMA UTIČNICA KABLOVSKA</p>  <p><b>02</b> 9,00</p>	<p>SMA UTIČNICA PANEL</p>  <p><b>03</b> 9,00</p>	<p>SMA UTIČNICA PRINT</p>  <p><b>04</b> 11,00</p>
<p>SMA UTIKAČ SMA UTIKAČ</p>  <p><b>05</b> 11,00</p>	<p>SMA UTIČNICA SMA UTIČNICA</p>  <p><b>06</b> 7,00</p>	<p>SMA UTIKAČ UHF UTIKAČ</p>  <p><b>07</b> 14,00</p>	<p>SMA UTIKAČ UHF UTIČNICA</p>  <p><b>08</b> 14,00</p>
<p>SMA UTIKAČ BNC UTIKAČ</p>  <p><b>09</b> 12,00</p>	<p>SMA UTIKAČ BNC UTIČNICA</p>  <p><b>10</b> 10,00</p>	<p>SMA UTIČNICA BNC UTIKAČ</p>  <p><b>11</b> 12,00</p>	<p>SMA UTIČNICA BNC UTIČNICA</p>  <p><b>12</b> 10,00</p>

**USB KONEKTORI . . . . . UT USB**

<p>USB-A MUŠKI USB-B ZENSKI</p>  <p><b>01</b> 6,00</p>	<p>USB-A ZENSKI USB-B MUŠKI</p>  <p><b>02</b> 6,00</p>	<p>USB-A ZENSKI USB-B ZENSKI</p>  <p><b>03</b> 6,00</p>
<p>USB-A ZENSKI USB-A ZENSKI</p>  <p><b>04</b> 6,00</p>	<p>USB-B ZENSKI USB-B ZENSKI</p>  <p><b>05</b> 6,00</p>	<p>USB UTIČNICE PRINT</p>  <p><b>A</b> . . . . .1,00      <b>B</b> . . . . .1,20</p>



**MREZNI UTIKAČI I UTIČNICE. . . . . UTMR**  
**MREZNE ŠASIJSKE UTIČNICE - MUŠKE . . . . . UTMRSAM**

**UGRADNA**

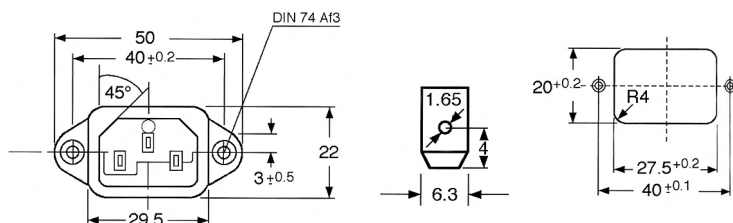

**U . . . . . 2,50**

**SNAP IN**

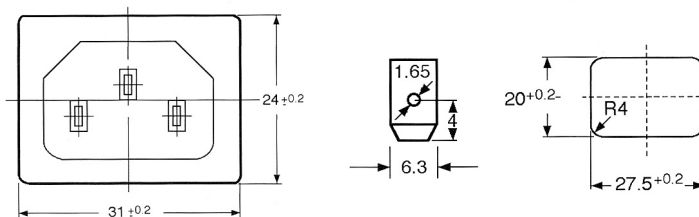
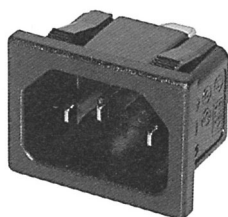

**S . . . . . 3,00**

**ZA ŠTAMPANU PLOČU (PRINT)**

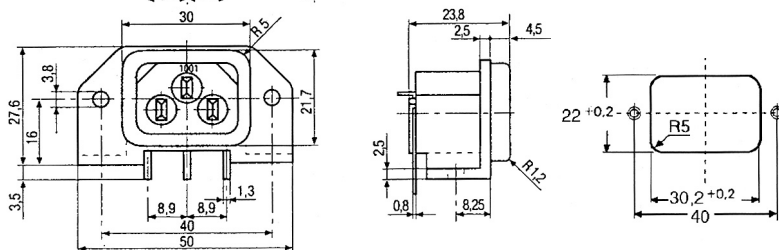
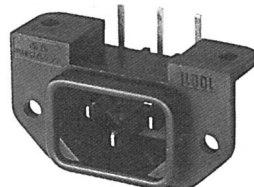
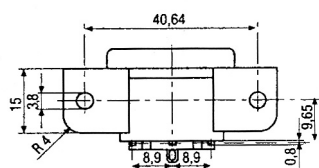

**P . . . . . 3,50**

**MREZNI UTIKAČI I UTIČNICE. . . . . UTMR**  
**MREZNE ŠASIJSKE UTIČNICE - MUŠKE . . . . . UTMRSAM**  
**SA OSIGURAČEM**

**HORIZONTALNA**

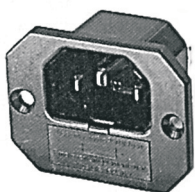

OH . . . . . 4,00

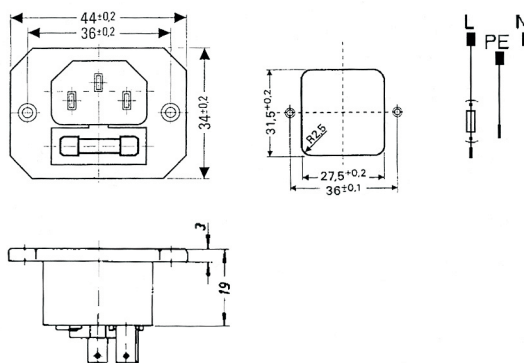

**VERTIKALNA**



OV . . . . . 4,00

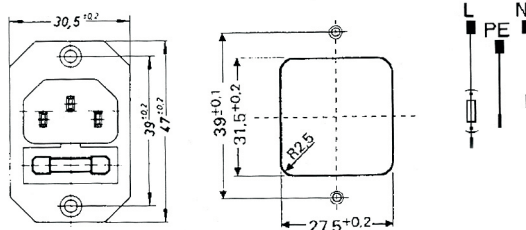

**SNAP IN**



OS . . . . . 5,00

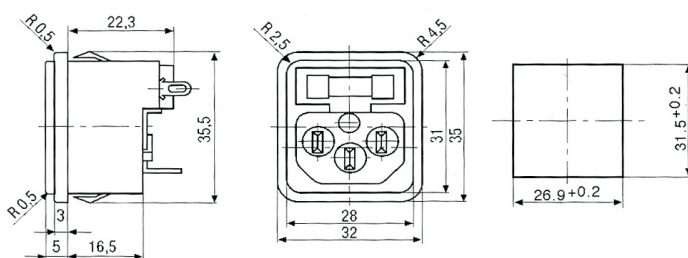

**MREZNA ŠASIJSKA UTIČNICA - MUŠKA MINI**



M . . . . . 1,50

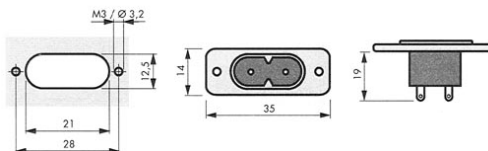

**MREZNI UTIKAČI I UTIČNICE. . . . . UTMR**  
**MREZNE ŠASIJSKE UTIČNICE - MUŠKE . . . . . UTMRSAM**  
**KOMPLET (SA OSIGURAČEM I PREKIDAČEM)**

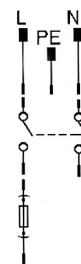
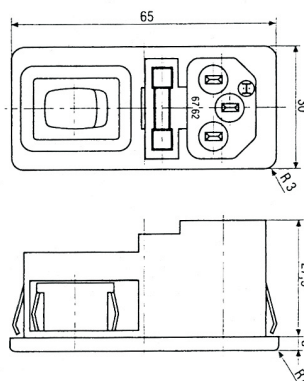
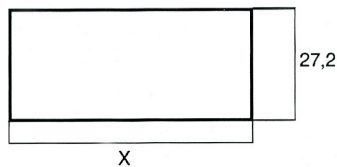
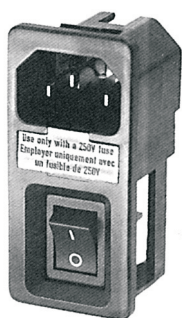

**K1 . . . . . 12,00**

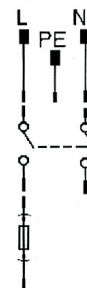
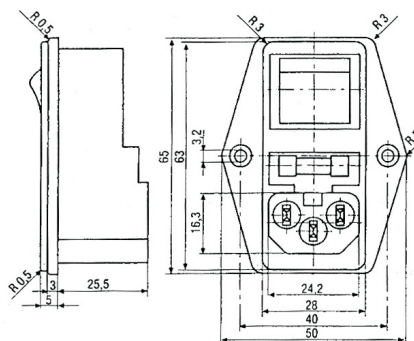
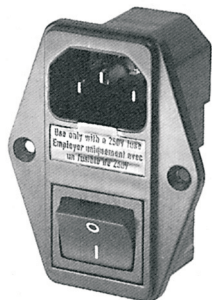

**K2 . . . . . 12,00**

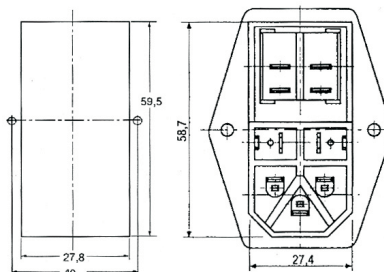

**MREZNI UTIKAČI I UTIČNICE. . . . . UTMR**  
**MREZNE ŠASIJSKE UTIČNICE - MUŠKE . . . . . UTMRSAM**  
**KOMPLET (SA OSIGURAČEM I PREKIDAČEM)**

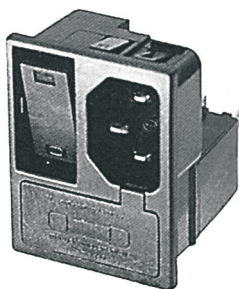

**K3 . . . . . 12,00**

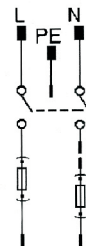
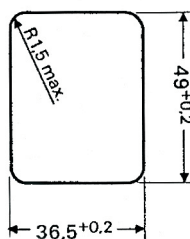
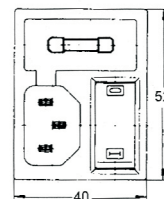
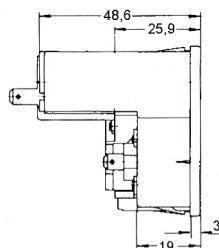

**K4 . . . . . 12,00**

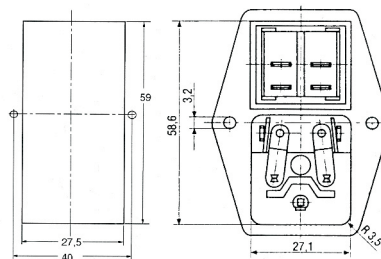
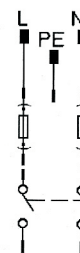
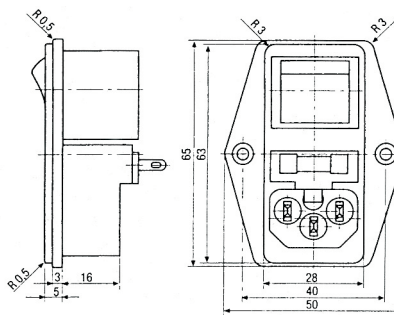

**MREZNI UTIKAČI I UTIČNICE. . . . . UTMR**  
**MREZNE ŠASIJSKE UTIČNICE - ZENSKE . . . . . UTMRSZ**

**UGRADNA**

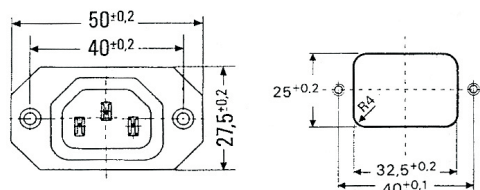
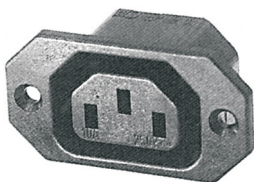

**U . . . . . 2,50**

**SNAP IN**

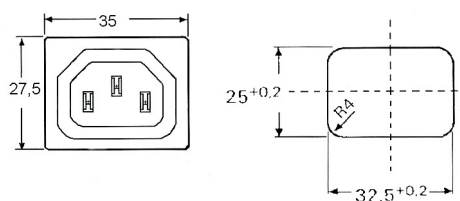
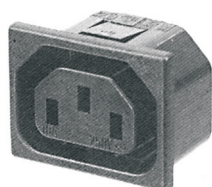

**S . . . . . 3,00**

**DVOSTRUKA**

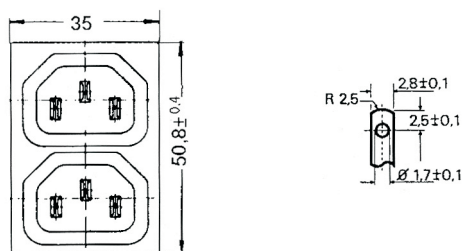
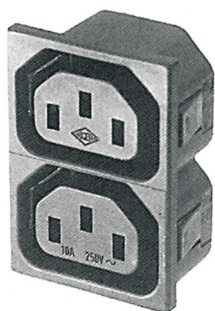

**D . . . . . 6,00**

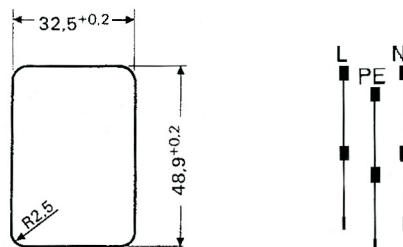

18000 Niš, Jovana Ristića 7, P.O.Box 135, Tel: 018 / 520-455, 522-814, 522-965, fax: 522-660  
<http://www.MGelectronic.co.yu> e-mail: [office@MGelectronic.co.yu](mailto:office@MGelectronic.co.yu)

MREZNI UTIKAČI I UTIČNICE. . . . . **UTMR**

MREZNI KABLOVSKI UTIKAČI . . . . . **UTMRKA**  
ZENSKI

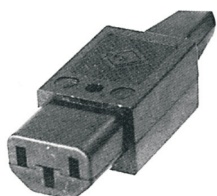

**Z** . . . . . 3,00

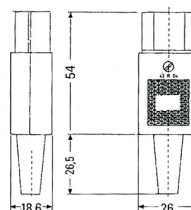

**ZENSKI UGAONI**

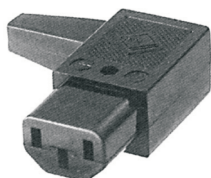

**ZU** . . . . . 4,00

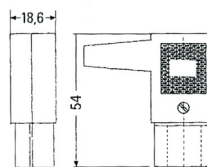

**ZENSKI MINII**



**ZM** . . . . . 2,00

**MUŠKI**



**M** . . . . . 4,00

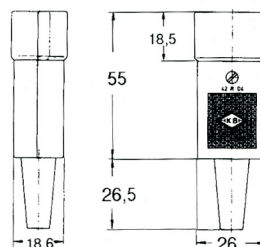

**MUŠKI UGAONI**



**MU** . . . . . 5,00

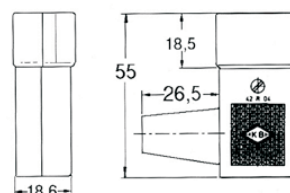



**CENTRONICS KONEKTORI . . . . . UTCEN**

**Tehnički podaci**

Izolator:	poliamid	Struja:	5 A
Kućište:	pocinkovani čelik	Otpor izolacije:	1000 MΩ (500 V min)
Kontakti:	mesing, zlato na niklu	Radna temperatura:	-55 ... +125°C
Ispitni napon:	1200 V eff (1 min.)		

**CENTRONICS UTIKAČI – KABLOVSKI MUŠKI . . . . . UTCENKM**

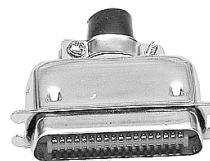
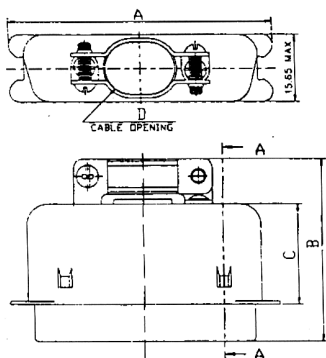

Tip-pol	Cena	Dimenzije u mm			
		A	B	C	D
14	3,50	38,0	40,0	21,0	φ 8
24	4,00	46,8	40,0	22,0	φ 11,8
36	3,50	61,6	41,0	23,0	15,8x11,8
50	6,00	76,7	44,0	25,0	15,8x11,8

**CENTRONICS UTIKAČI – KABLOVSKI ZENSKI . . . . . UTCENKZ**

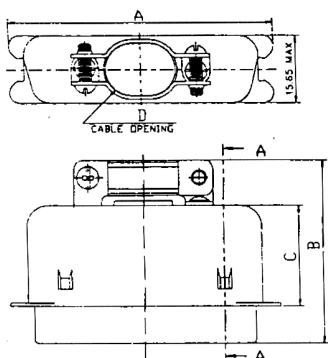

Tip-pol	Cena	Dimenzije u mm			
		A	B	C	D
14	6,00	38,0	40,0	21,0	φ 8
36	5,00	61,6	41,0	23,0	15,8x11,8
50	7,00	76,7	44,0	25,0	15,8x11,8

**CENTRONICS UTIČNICE – ŠASIJSKE . . . . . UTCENS**

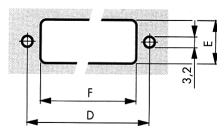
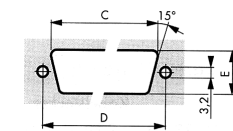
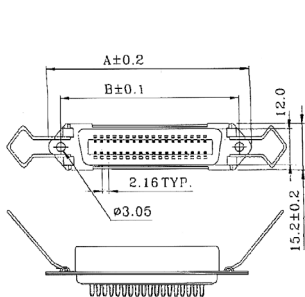

Tip-pol	Cena	Dimenzije u mm					
		A	B	C	D	E	F
14	3,50	44,4	36,0	29,0	36,0	16,0	25,3
24	3,50	55,2	46,8	40,1	46,8	16,0	36,1
36	2,50	68,2	59,8	52,5	59,8	16,0	49,0
50	3,50	83,1	74,8	68,1	74,8	16,0	64,0

18000 Niš, Jovana Ristića 7, P.O.Box 135, Tel: 018 / 520-455, 522-814, 522-965, fax: 522-660  
<http://www.MGelectronic.co.yu> e-mail: [office@MGelectronic.co.yu](mailto:office@MGelectronic.co.yu)



**CENTRONICS KONEKTORI . . . . . UTCEN**

**CENTRONICS UTIČNICE – PRINT . . . . . UTCENP**

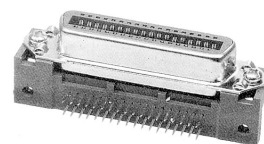
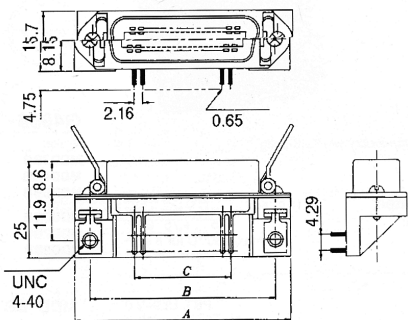

Tip-pol	Cena	Dimenzije u mm		
		A	B	C
<b>24</b>	5,00	55,0	47,0	24,0
<b>36</b>	5,00	68,0	60,0	37,0
<b>50</b>	7,00	83,0	75,0	52,0

**CENTRONICS UTIČNICE ZA FLET KABL ZENSKE . . . . . UTCENFZ**

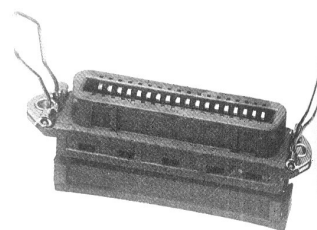
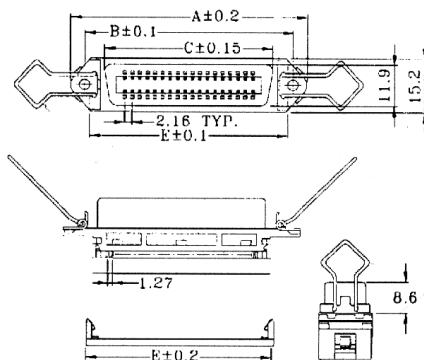

Tip-pol	Cena	Dimenzije u mm				
		A	B	C	D	E
<b>36</b>	5,00	67,0	60,0	48,9	58,0	51,0
<b>50</b>	8,00	83,0	75,0	64,0	73,0	69,0

**CENTRONICS UTIKAČI ZA FLET KABL MUŠKI . . . . . UTCENFM**

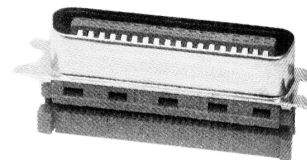
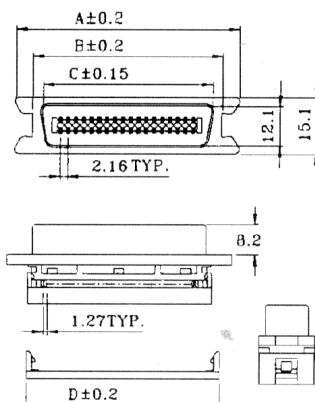

Tip-pol	Cena	Dimenzije u mm			
		A	B	C	D
<b>36</b>	5,00	61,0	51,0	49,2	50,79
<b>50</b>	8,00	76,0	66,0	64,8	51,84

**SUB-D KONEKTORI . . . . . UTSD**  
**SUB-D KONEKTORI – STANDARDNI . . . . . UTSDS**

**Tehnički podaci**

Izolacioni materijal: poliamid  
 Kućište: čelik – pocinkovan  
 Kontakti: mesing, zlato na niklu  
 Dopuštena struja po kontaktu: 5A max.  
 Radni napon: 125 V<sub>eff</sub>  
 Ispitni napon: 1000V, 50Hz, 1min.  
 Prolazni otpor: ≤ 3 x 10<sup>-3</sup> Ω  
 Radna temperatura: -55... +125°C

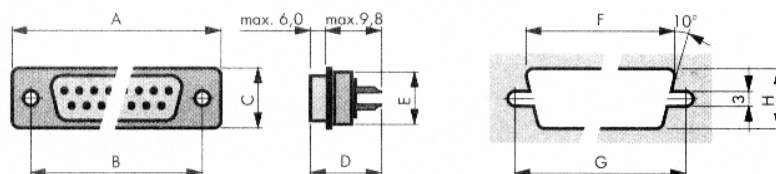
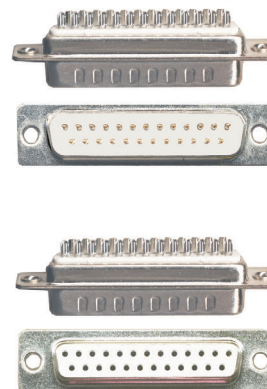

	Tip	Pol	Cena	Dimenzije u mm							
				A	B	C	D	E	F	G	H
<b>Muški</b>	<b>M09</b>	09	0,70	30,8	25,0	12,5	15,8	11,0	22,2	25,0	12,3
	<b>M15</b>	15	0,80	39,2	33,3	12,5	15,8	11,2	30,5	33,3	12,3
	<b>M19</b>	19	1,20	44,94	38,94	12,5	15,8	11,2	30,5	38,94	12,3
	<b>M23</b>	23	1,20	50,30	44,28	12,5	15,8	11,2	36,10	44,28	12,3
	<b>M25</b>	25	0,90	53,0	47,1	12,5	15,8	11,2	44,3	47,1	12,3
	<b>M37</b>	37	1,80	69,3	63,5	12,5	15,8	11,2	60,7	63,5	12,3
	<b>M50</b>	50	4,00	66,9	61,1	15,4	15,8	14,0	58,3	61,1	15,3
<b>Zenski</b>	<b>Z09</b>	09	0,70	30,8	25,0	12,5	15,8	11,0	22,2	25,0	12,3
	<b>Z15</b>	15	0,80	39,2	33,3	12,5	15,8	11,2	30,5	33,3	12,3
	<b>Z19</b>	19	1,20	44,94	38,94	12,5	15,8	11,2	30,00	38,94	12,3
	<b>Z23</b>	23	1,20	50,30	44,28	12,5	15,8	11,2	35,75	44,28	12,3
	<b>Z25</b>	25	0,90	53,0	47,1	12,5	15,8	11,2	44,3	47,1	12,3
	<b>Z37</b>	37	1,80	69,3	63,5	12,5	15,8	11,2	60,7	63,5	12,3
	<b>Z50</b>	50	4,00	66,9	61,1	15,4	15,8	14,0	58,3	61,1	15,3

18000 Niš, Jovana Ristića 7, P.O.Box 135, Tel: 018 / 520-455, 522-814, 522-965, fax: 522-660  
<http://www.MGelectronic.co.yu> e-mail: [office@MGelectronic.co.yu](mailto:office@MGelectronic.co.yu)

**SUBD KONEKTORI . . . . . UTSD**  
**SUB-D KONEKTORI ZA ŠTAMPANU PLOČU . . . . . UTSDP**

**Tehnički podaci**

Izolacioni materijal: poliamid  
 Kućište: čelik – pocinkovan  
 Kontakti: mesing, zlato na niklu  
 Dopuštena struja po kontaktu: 5A max.  
 Radni napon: 125 V<sub>eff</sub>  
 Ispitni napon: 1000V, 50Hz, 1min.  
 Prolazni otpor: ≤ 3 x 10<sup>-3</sup> Ω  
 Radna temperatura: -55... +125°C

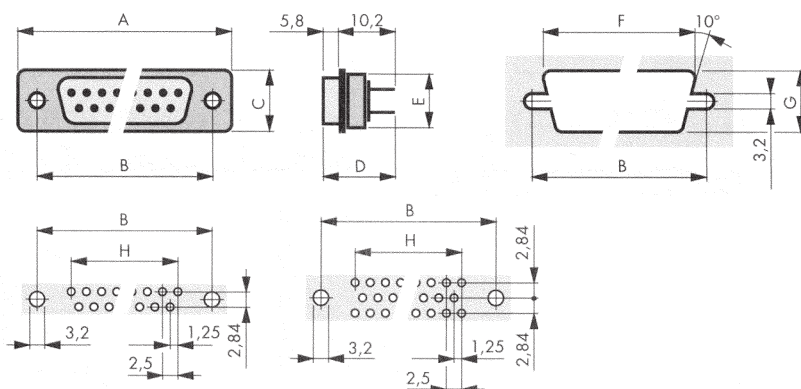

	Tip	Pol	Cena	Dimenzije u mm								
				A	B	C	D	E	F	G	H	K
<b>Muški</b>	<b>M09</b>	9	2,00	30,8	25,0	12,5	16,0	11,0	18,2	10,0	10,96	1,37
	<b>M15</b>	15	3,00	39,2	33,3	12,5	16,0	11,4	26,6	10,0	19,18	1,37
	<b>M25</b>	25	4,00	53,0	47,1	12,5	16,0	11,3	40,0	10,0	33,12	1,38
	<b>M37</b>	37	6,00	69,3	63,5	12,5	16,0	11,3	56,6	10,0	49,68	1,38
	<b>M50</b>	50	8,00	66,9	61,1	15,4	16,0	15,0	54,5	12,8	44,16	1,38
<b>Zenski</b>	<b>Z09</b>	9	3,00	30,8	25,0	12,5	16,0	11,0	16,6	8,0	10,96	1,37
	<b>Z15</b>	15	4,00	39,2	33,3	12,5	16,0	11,4	25,0	8,0	19,18	1,37
	<b>Z25</b>	25	5,00	53,0	47,1	12,5	16,0	11,3	39,2	8,0	33,12	1,38
	<b>Z37</b>	37	8,00	69,3	63,5	12,5	16,0	11,3	55,0	8,0	49,68	1,38
	<b>Z50</b>	50	10,00	66,9	61,1	15,4	16,0	15,0	52,6	11,4	44,16	1,38

**SUB-D KONEKTORI . . . . . UTSD**  
**SUB-D KONEKTORI ZA ŠTAMPANU PLOČU - UGAONI 90° . . . . . UTSDU**

**Tehnički podaci**

Izolacioni materijal: poliamid  
 Kućište: čelik – pocinkovan  
 Kontakti: mesing, zlato na niklu  
 Dopuštena struja po kontaktu: 5A max.  
 Radni napon: 125 V<sub>eff</sub>  
 Ispitni napon: 1000V, 50Hz, 1min.  
 Prolazni otpor: ≤ 3 x 10<sup>-3</sup> Ω  
 Radna temperatura: -55... +125°C

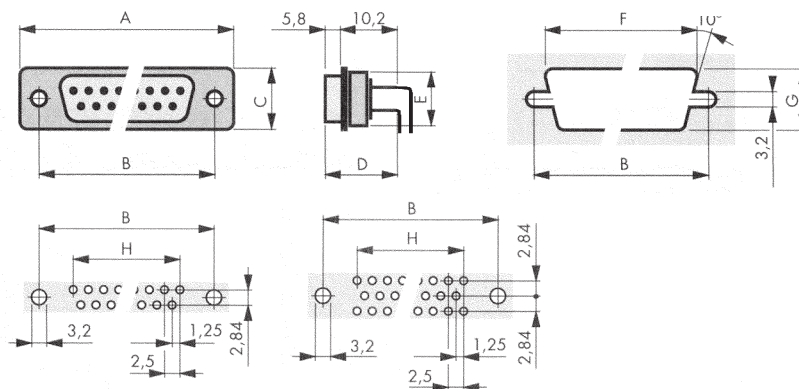
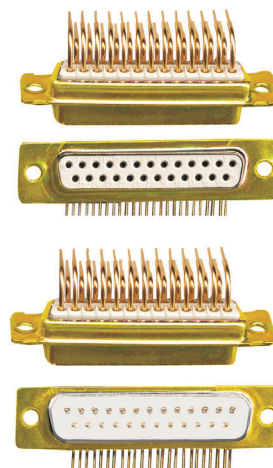

	Tip	Pol	Cena	Dimenzije u mm								
				A	B	C	D	E	F	G	H	K
<b>Muški</b>	<b>M09</b>	9	3,00	30,8	25,0	12,5	16,0	11,0	18,2	10,0	10,96	1,37
	<b>M15</b>	15	4,50	39,2	33,3	12,5	16,0	11,4	26,6	10,0	19,18	1,37
	<b>M25</b>	25	6,00	53,0	47,1	12,5	16,0	11,3	40,0	10,0	33,12	1,38
	<b>M37</b>	37	9,00	69,3	63,5	12,5	16,0	11,3	56,6	10,0	49,68	1,38
	<b>M50</b>	50	14,00	66,9	61,1	15,4	16,0	15,0	54,5	12,8	44,16	1,38
<b>Zenski</b>	<b>Z09</b>	9	3,50	30,8	25,0	12,5	16,0	11,0	16,6	8,0	10,96	1,37
	<b>Z15</b>	15	5,00	39,2	33,3	12,5	16,0	11,4	25,0	8,0	19,18	1,37
	<b>Z25</b>	25	7,00	53,0	47,1	12,5	16,0	11,3	39,2	8,0	33,12	1,38
	<b>Z37</b>	37	11,00	69,3	63,5	12,5	16,0	11,3	55,0	8,0	49,68	1,38
	<b>Z50</b>	50	16,00	66,9	61,1	15,4	16,0	15,0	52,6	11,4	44,16	1,38

18000 Niš, Jovana Ristića 7, P.O.Box 135, Tel: 018 / 520-455, 522-814, 522-965, fax: 522-660  
<http://www.MGelectronic.co.yu> e-mail: [office@MGelectronic.co.yu](mailto:office@MGelectronic.co.yu)

**SUBD KONEKTORI . . . . . UTSD**

**SUBD KONEKTORI ZA ŠTAMPANU PLOČU – SA NOSAČEM . . . . . UTSDN**

**Tehnički podaci**

Ispitni napon: 1000 V  
 Nazivna struja: 5 A  
 Kontakti: mesing, 0,1 µm zlata na niklu  
 Kontakt za masu: integrisan  
 Zaštita metala: pocinkovan  
 Radna temperatura: -55... +105°C

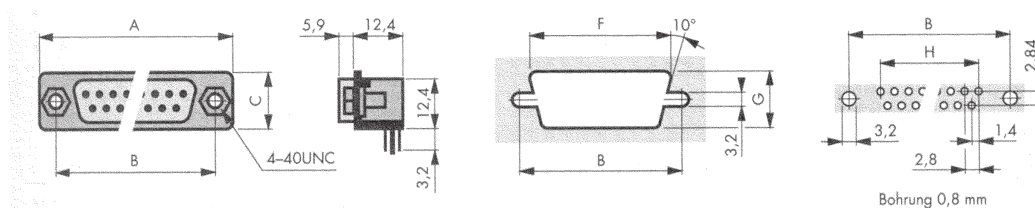
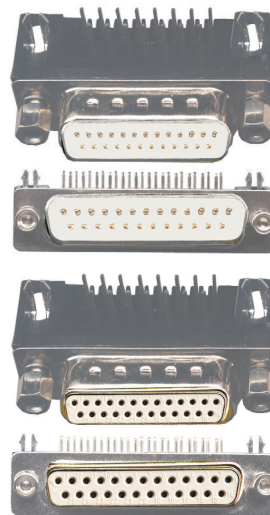

	Tip	Pol	Cena	Dimenzije u mm					
				A	B	C	F	G	H
<b>Muški</b>	<b>M09</b>	9	1,40	30,9	25,0	12,4	19,3	10,0	11,07
	<b>M15</b>	15	1,60	39,2	33,3	12,4	27,4	10,0	19,38
	<b>M25</b>	25	1,90	53,0	47,0	12,4	41,1	10,0	33,25
	<b>M37</b>	37	3,20	69,4	63,5	12,4	57,9	10,0	49,86
<b>Zenski</b>	<b>Z09</b>	9	1,40	30,9	25,0	12,4	19,3	10,0	11,07
	<b>Z15</b>	15	1,60	39,2	33,3	12,4	27,4	10,0	19,38
	<b>Z25</b>	25	1,90	53,0	47,0	12,4	41,1	10,0	33,25
	<b>Z37</b>	37	3,20	69,4	63,5	12,4	57,9	10,0	49,86

**SUB-D KONEKTORI . . . . . UTSD**

**SUB-D KONEKTORI ZA FLET KABL . . . . . UTSDF**

**Tehnički podaci**

Materijal za kućište: poliester ojačan staklenim vlaknima  
okvir od niklovanog čelika

Boja: plastika siva, okvir srebrnast  
legiran bakrom

Kontakti: 0,3 μm zlata na 2,5 μm nikla

Raster: 1,27 mm

Ispitni napon: 1000 V<sub>eff.</sub>

Struja: 1A

Radna temperatura: -55... +125°C

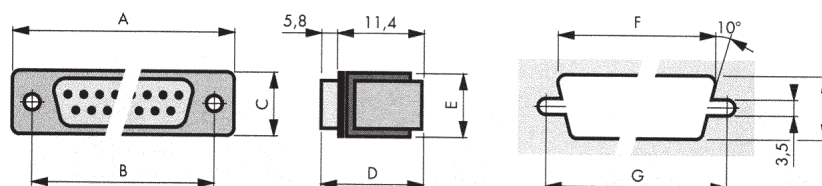

	Tip	Pol	Cena	Dimenzije u mm							
				A	B	C	D	E	F	G	H
<b>Muški</b>	<b>M09</b>	9	3,00	30,9	25,0	12,7	16,0	12,7	19,1	25,0	10,0
	<b>M15</b>	15	3,50	39,2	33,3	12,7	16,0	12,7	27,0	33,3	10,0
	<b>M25</b>	25	4,00	53,0	47,0	12,7	16,0	12,7	41,0	47,0	10,0
	<b>M37</b>	37	8,50	69,4	63,5	12,7	16,0	12,7	57,2	63,5	10,0
<b>Zenski</b>	<b>Z09</b>	9	3,00	30,9	25,0	12,7	16,0	12,7	19,1	25,0	8,0
	<b>Z15</b>	15	3,50	39,2	33,3	12,7	16,0	12,7	27,0	33,3	8,0
	<b>Z25</b>	25	4,00	53,0	47,0	12,7	16,0	12,7	41,0	47,0	8,0
	<b>Z37</b>	37	8,50	69,4	63,5	12,7	16,0	12,7	57,2	63,5	8,0

18000 Niš, Jovana Ristića 7, P.O.Box 135, Tel: 018 / 520-455, 522-814, 522-965, fax: 522-660  
<http://www.MGelectronic.co.yu> e-mail: [office@MGelectronic.co.yu](mailto:office@MGelectronic.co.yu)



**SUB-D KONEKTORI . . . . . UTSD**  
**SUB-D KONEKTORI HD (HIGH DENSITY) . . . . . UTSDHD**

**Tehnički podaci**

Prolazni otpor: < 5mΩ  
 Otpor izolacije: >5 × 10<sup>9</sup> Ω  
 Kapacitet: ≤5pF na 1 MHz  
 Ispitni napon: 1000 V  
 Radni napon: 250 V  
 Struja: 1,5 A  
 Nozica: bakar-berilijum  
 0,1 μm zlato na niklu  
 Utičnica: fosfor-bronza  
 0,1 μm zlato na niklu  
 Radna temperatura: -55... +105°C

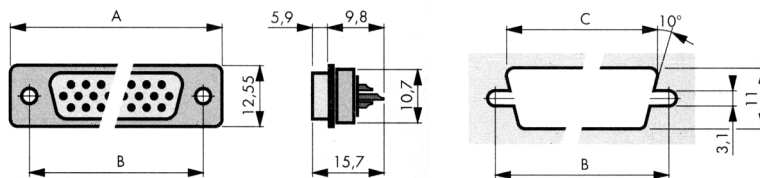
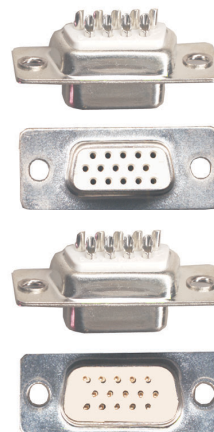

	Tip	Pol	Cena	Dimenzije u mm		
				A	B	C
<b>Muški</b>	<b>M15</b>	15	1,40	30,80	24,99	16,90
	<b>M44</b>	44	3,20	53,00	47,04	39,00
<b>Zenski</b>	<b>Z15</b>	15	1,40	30,80	24,99	16,90
	<b>Z44</b>	44	3,20	53,00	47,04	39,00

**SUBD KONEKTORI . . . . . UTSD**  
**SUBD KOMBINOVANI KONEKTORI . . . . . UTSDC**

**Tehnički podaci**

Izolacioni materijal: poliamid  
 Kućište: čelik – pocinkovan  
 Kontakti: mesing, zlato na niklu  
 Dopuštena struja po kontaktu: 5A max.  
 Radni napon: 125 V<sub>eff</sub>  
 Ispitni napon: 1000V, 50Hz, 1min.  
 Prolazni otpor: ≤ 3 x 10<sup>-3</sup> Ω  
 Radna temperatura: -55... +125°C

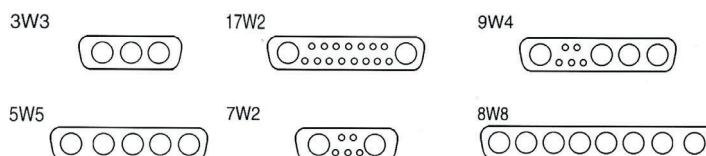
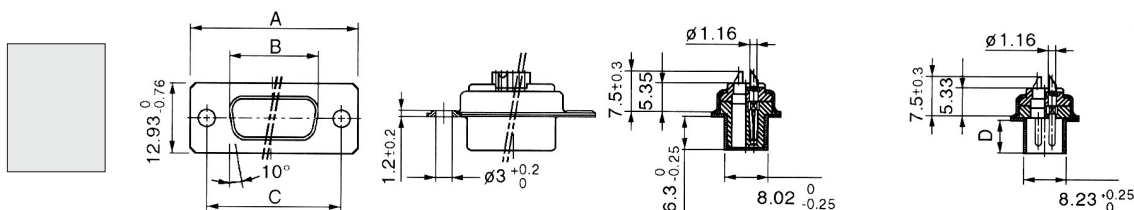
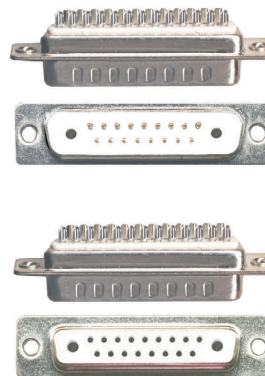

	Tip	Pol	Cena	Dimenzije u mm				
				A	B	C	D	
<b>Muški</b>	<b>M15-3W3</b>	15	3W3	3,00	39,52	25,12	33,30	6,12
	<b>M15-7W2</b>	15	7W2	6,00	39,52	25,12	33,30	6,12
	<b>M25-5W5</b>	25	5W5	4,00	53,42	38,84	47,04	5,99
	<b>M25-9W4</b>	25	9W4	6,00	53,42	38,84	47,04	5,99
	<b>M25-17W2</b>	25	17W2	9,00	53,42	38,84	47,04	5,99
	<b>M37-8W8</b>	37	8W8	5,00	69,70	55,30	63,50	5,99
<b>Zenski</b>	<b>Z15-3W3</b>	15	3W3	3,00	39,52	24,79	33,30	16,0
	<b>Z15-7W2</b>	15	7W2	7,00	39,52	24,79	33,30	16,0
	<b>Z25-5W5</b>	25	5W5	4,00	53,42	38,84	47,04	16,0
	<b>Z25-9W4</b>	25	9W4	7,00	53,42	38,84	47,04	16,0
	<b>Z25-17W2</b>	25	17W2	12,00	53,42	38,84	47,04	16,0
	<b>Z37-8W8</b>	37	8W8	5,00	69,70	55,30	63,50	16,0

18000 Niš, Jovana Ristića 7, P.O.Box 135, Tel: 018 / 520-455, 522-814, 522-965, fax: 522-660  
<http://www.MGelectronic.co.yu> e-mail: [office@MGelectronic.co.yu](mailto:office@MGelectronic.co.yu)

**SUB-D KONEKTORI . . . . . UTSD**  
**KUČIŠTA ZA SUB-D KONEKTORE . . . . . UTSDK**

Tip	Pol	Cena	Dimenzije u mm				
			A	B	C	D	E
09	9	0,80	31,0	25,0	39,5	20,5	16,0
15	15	0,90	39,0	33,3	35,5	28,0	16,0
19	19	1,20	45,2	38,9	41,8	34,0	16,0
23	23	1,40	50,4	44,2	41,8	37,0	16,0
25	25	1,00	53,2	47,0	42,0	41,0	16,5
37	37	1,50	72,0	63,5	50,0	51,0	23,0
50	50	2,80	69,1	61,1	45,0	54,1	20,0

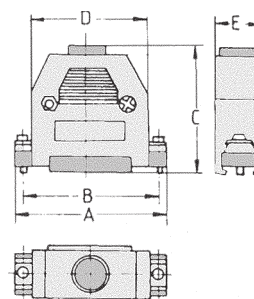
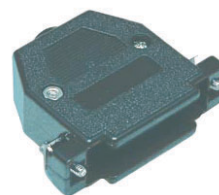

**KUČIŠTA ZA SUB-D ADAPTERE . . . . . UTSDKA**

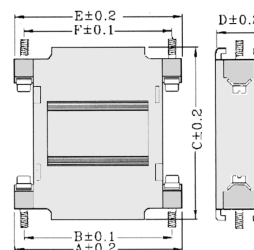
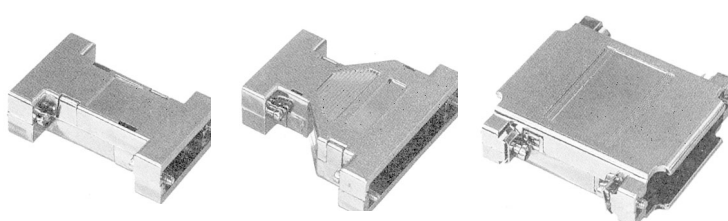

Tip	Pol	Cena	Dimenzije u mm					
			A	B	C	D	E	F
<b>9/9</b>	2 x 9	2,50	33,0	24,99	52,7	16,0	33,0	24,99
<b>9/25</b>	1 x 9 / 1 x 25	2,80	33,0	24,99	52,0	16,5	55,0	47,04
<b>25/25</b>	2 x 25	3,00	55,0	47,04	56,5	15,3	55,0	47,04

**SUB-D KONEKTORI . . . . . UTSD**
**SUB-D ADAPTERI . . . . . UTSDA**

Tip	Opis	Cena
<b>9Z / 9Z</b>	9 PINA ŽENSKI / ŽENSKI	4,00
<b>9M / 9M</b>	9 PINA MUŠKI / MUŠKI	4,00
<b>9M / 9Z</b>	9 PINA MUŠKI / ŽENSKI	4,00
<b>15Z / 15Z</b>	15 PINA ŽENSKI / ŽENSKI	5,00
<b>15M / 15M</b>	15 PINA MUŠKI / MUŠKI	5,00
<b>15M / 15Z</b>	15 PINA MUŠKI / ŽENSKI	5,00
<b>25Z / 25Z</b>	25 PINA ŽENSKI / ŽENSKI	6,00
<b>25M / 25M</b>	25 PINA MUŠKI / MUŠKI	6,00
<b>25M / 25Z</b>	25 PINA MUŠKI / ŽENSKI	6,00
<b>9Z / 25Z</b>	9 PINA ŽENSKI / 25 PINA ŽENSKI	6,00
<b>9Z / 25M</b>	9 PINA ŽENSKI / 25 PINA MUŠKI	6,00
<b>9M / 25Z</b>	9 PINA MUŠKI / 25 PINA ŽENSKI	6,00
<b>9M / 25M</b>	9 PINA MUŠKI / 25 PINA MUŠKI	6,00
<b>25Z / RJ45</b>	25 PINA ŽENSKI / UTIČNICA RJ45	4,00
<b>25M / RJ45</b>	25 PINA MUŠKI / UTIČNICA RJ45	4,00
<b>9M / RJ45</b>	9 PINA MUŠKI / UTIČNICA RJ45	4,00
<b>JUMPER</b>	25 PINA MUŠKI / 25 PINA ŽENSKI	12,00

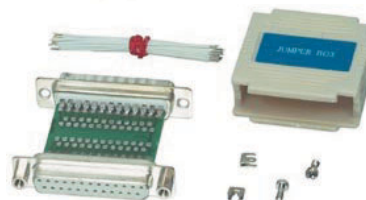
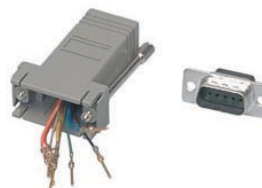
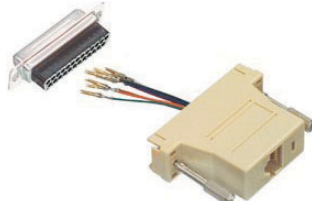
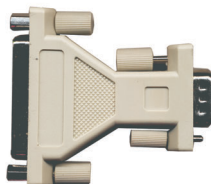
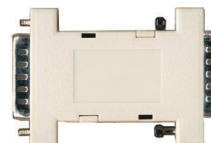
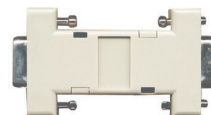

**SUB-D KONEKTORI . . . . . UTSD**  
**SUB-D ADAPTERI . . . . . UTSDA**  
**STANDARD / NULL MODEM ADAPTERI . . . . . UTSDAN**

Tip	Opis	Cena
<b>25Z / 25Z</b>	25 PINA ZENSKI / ZENSKI	8,00
<b>25M / 25M</b>	25 PINA MUŠKI / MUŠKI	8,00
<b>25M / 25Z</b>	25 PINA MUŠKI / ZENSKI	8,00

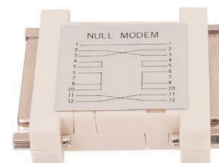

**SUB-D / PS2 ADAPTERI . . . . . UTSDAP**

Tip	Opis	Cena
<b>9M / PS2Z</b>	9 PINA ZENSKI / PS2 ZENSKI	4,00
<b>9M / PS2M</b>	9 PINA MUŠKI / PS2 MUŠKI	4,00
<b>9Z / PS2Z</b>	9 PINA ZENSKI / PS2 ZENSKI	4,00



**MINI SUB-D ADAPTERI . . . . . UTSDAM**

Tip	Opis	Cena
<b>9Z / 9Z</b>	9 PINA ZENSKI / ZENSKI	5,00
<b>9M / 9M</b>	9 PINA MUŠKI / MUŠKI	5,00
<b>9M / 9Z</b>	9 PINA MUŠKI / ZENSKI	5,00
<b>15Z / 15Z</b>	15 PINA ZENSKI / ZENSKI	6,00
<b>15M / 15M</b>	15 PINA MUŠKI / MUŠKI	6,00
<b>15M / 15Z</b>	15 PINA MUŠKI / ZENSKI	6,00
<b>25Z / 25Z</b>	25 PINA ZENSKI / ZENSKI	7,00
<b>25M / 25M</b>	25 PINA MUŠKI / MUŠKI	7,00
<b>25M / 25Z</b>	25 PINA MUŠKI / ZENSKI	7,00
<b>9Z / 25Z</b>	9 PINA ZENSKI / 25 PINA ZENSKI	5,00
<b>9Z / 25M</b>	9 PINA ZENSKI / 25 PINA MUŠKI	5,00
<b>9M / 25Z</b>	9 PINA MUŠKI / 25 PINA ZENSKI	5,00
<b>9M / 25M</b>	9 PINA MUŠKI / 25 PINA MUŠKI	5,00
<b>37M / 37M</b>	37 PINA MUŠKI / MUŠKI	9,00
<b>37Z / 37Z</b>	37 PINA ZENSKI / ZENSKI	12,00



**SUB-D HD (VGA) ADAPTERI . . . . . UTSDAHD**

Tip	Opis	Cena
<b>15Z / 15Z</b>	15 PINA ZENSKI / 15 PINA ZENSKI	4,00
<b>15M / 15M</b>	15 PINA MUŠKI / 15 PINA MUŠKI	4,00
<b>15Z / 15Z</b>	15 PINA MUŠKI / 15 PINA ZENSKI	4,00

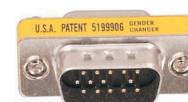

**SUB-D KONEKTORI . . . . . UTSD**

**DR AČI ZA SUB-D KONEKTORE 90° ZA ŠTAMPANU PLOČU . . . . . UTSDD**

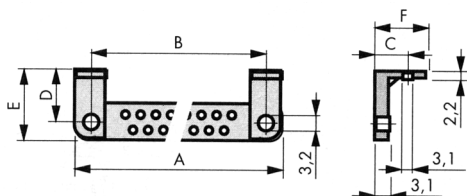

Tip	Pol	Cena	Dimenzije u mm					
			A	B	C	D	E	F
09	9	0,85	30,9	25,0	7,4	10,7	14,6	12,7
15	15	0,95	39,2	33,3	7,4	10,7	14,6	12,7
25	25	1,00	53,0	47,0	7,4	10,7	14,6	12,7
37	37	1,20	69,5	63,5	7,4	10,7	14,6	12,7
50	50	1,30	67,1	61,1	8,8	11,9	17,2	14,0

**KOMPLET VIJAKA ZA SUB-D KONEKTORE . . . . . UTSDV**



Cena: 0,90

**KONTAKTI ZA SUB-D KOMBINOVANE KONEKTORE . . . . . UTSDC**

**MUŠKI . . . . . UTSDCKM**

Tip	Cena	Provodnik	I (A)	Dimenzije u mm	
				A	B
10	3,50	AWG 16-20	10	1,8	1,8
20	3,50	AWG 12-14	20	2,7	2,7
40	3,50	AWG 8-10	40	4,8	4,8

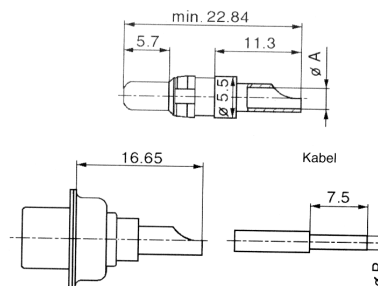

**ZENSKI . . . . . UTSDCKZ**

Tip	Cena	Provodnik	I (A)	Dimenzije u mm	
				A	B
10	4,50	AWG 16-20	10	1,8	1,8
20	4,50	AWG 12-14	20	2,7	2,7
40	4,50	AWG 8-10	40	4,8	4,8

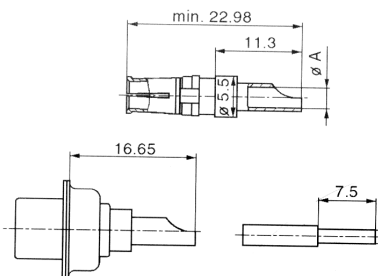



**AMP MIKRO KONEKTORI . . . . . UTKM**

**Tehnički podaci**

Izolacioni materijal: Termoplastika  
 Kontakti: Mesing, niklovan  
 Struja po kontaktu: 1,5 A  
 Radni napon: 230 V  
 Otpor izolacije: 1000 MΩ  
 Radna temperatura: -55... +105°C

**KABLOVSKI, ZENSKI . . . UTKMKZ**

Tip	Pol	Cena	Dimenzije u mm		
			A	B	C
04	4	1,20	8,6	5,4	3,81
06	6	1,40	11,1	8,0	6,35
08	8	1,70	13,6	10,5	8,89
10	10	1,90	16,2	13,0	11,43
12	12	2,10	18,7	15,6	13,97
14	14	2,40	21,3	18,1	16,51
16	16	2,60	23,8	20,7	19,05
20	20	3,00	28,9	25,7	24,13

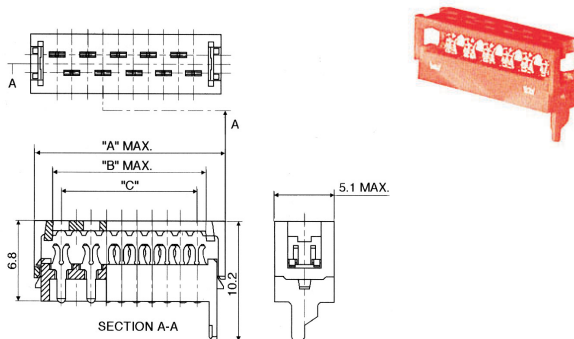

**PRINT, MUŠKI . . . . . UTKMPM**

Tip	Pol	Cena	Dimenzije u mm	
			A	B
04	4	0,80	3,81	7,1
06	6	1,00	6,35	9,7
08	8	1,20	8,89	12,2
10	10	1,40	11,43	14,7
12	12	1,70	13,97	17,3
14	14	2,00	16,51	19,8
16	16	2,20	19,05	22,4
20	20	2,60	24,13	27,4

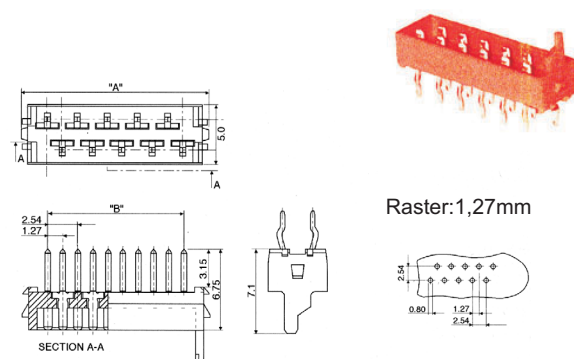

**PRINT, ZENSKI . . . . . UTKMPZ**

Tip	Pol	Cena	Dimenzije u mm	
			A	B
04	4	1,00	3,81	7,1
06	6	1,20	6,35	9,7
08	8	1,40	8,89	12,2
10	10	1,60	11,43	14,7
12	12	1,80	13,97	17,3
14	14	2,00	16,51	19,8
16	16	2,20	19,05	22,4
20	20	2,60	24,13	27,4

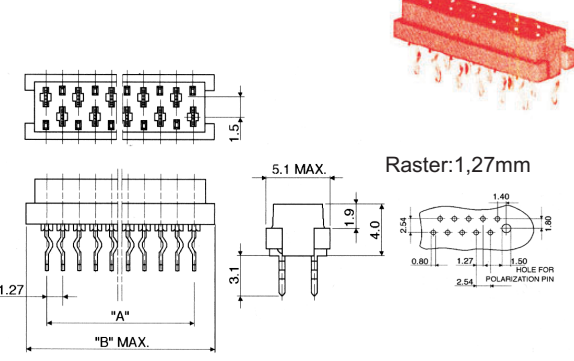

**KONEKTORI DIN 41612 – B (a + b) . . . . . UTKB**

**Tehnički podaci:**

Kontakti: zlato / nikl                      Ciklično uticanje: 400  
 Ispitni napon: 1000 V<sub>eff</sub>                    Otpornost kontakata: ≤ 15mΩ  
 Struja: 2A / 20°C                            Otpor izolacije: ≥ 10<sup>12</sup>Ω  
 Stepen povećanih zahteva: 2              Radna temperatura: -65 ... +125°C

**MUŠKI**

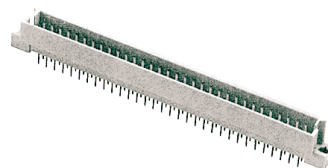
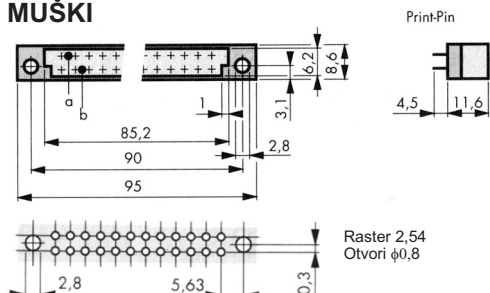

Tip	Cena	Pol
<b>M64</b>	4,50	2 x 32 (a + b)

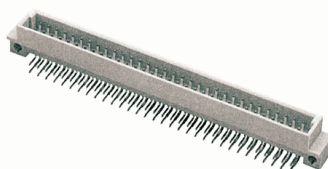
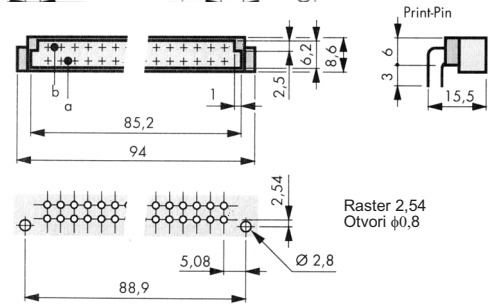

Tip	Cena	Pol
<b>M64U</b>	5,00	2 x 32 (a + b) 90°

**ZENSKI**

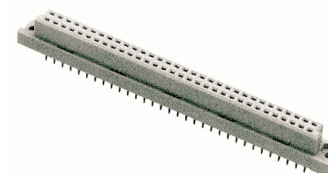
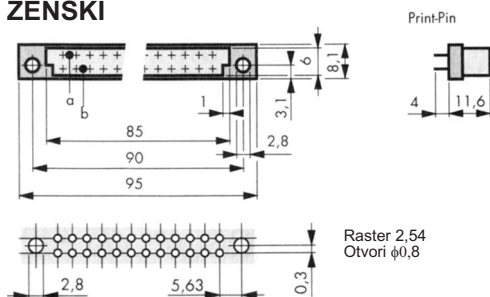

Tip	Cena	Pol
<b>Z64</b>	5,50	2 x 32 (a + b)

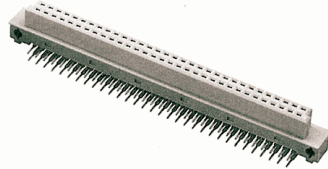
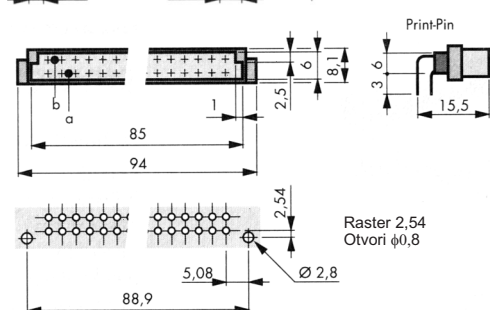

Tip	Cena	Pol
<b>Z64U</b>	6,00	2 x 32 (a + b) 90°

18000 Niš, Jovana Ristića 7, P.O.Box 135, Tel: 018 / 520-455, 522-814, 522-965, fax: 522-660  
<http://www.MGelectronic.co.yu> e-mail: [office@MGelectronic.co.yu](mailto:office@MGelectronic.co.yu)

**KONEKTORI DIN 41612 – C ( a + b + c ) . . . . . UTKC**

**Tehnički podaci:**

Kontakti: zlato / nikl  
Ispitni napon: 1000 V<sub>eff</sub>  
Struja: 2A / 20°C  
Stepen povećanih zahteva: 2

Ciklično uticanje: 400  
Otpornost kontakata: ≤ 15mΩ  
Otpor izolacije: ≥ 10<sup>12</sup>Ω  
Radna temperatura: -65 ... +125°C

**MUŠKI**

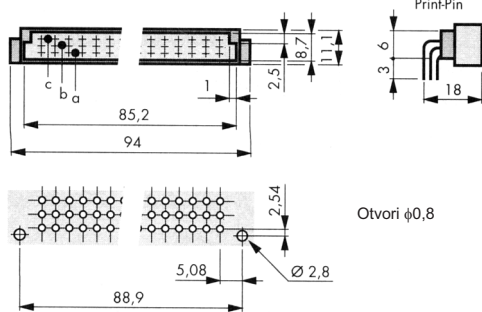
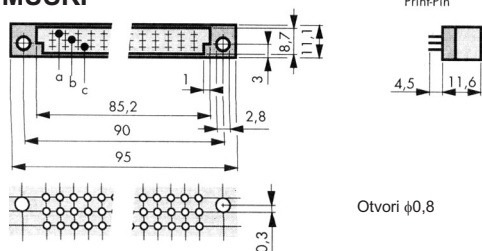

**ZENSKI**

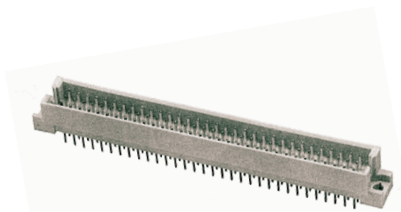
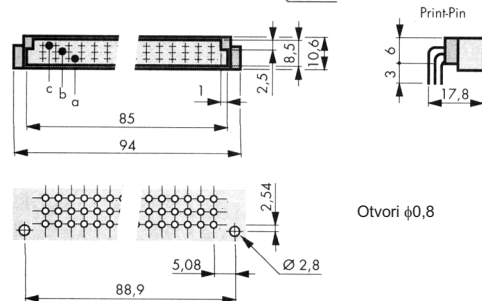
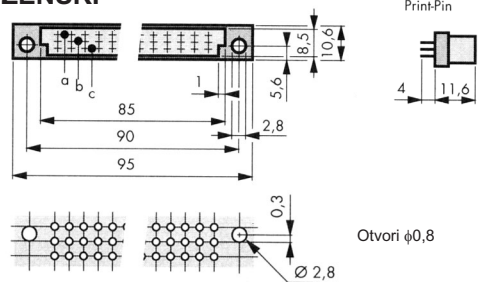

Tip	Cena	Pol	Raster
<b>M64</b>	4,50	2 x 32 (a + c)	2,54
<b>M96</b>	6,00	3 x 32 (a + b + c)	2,54

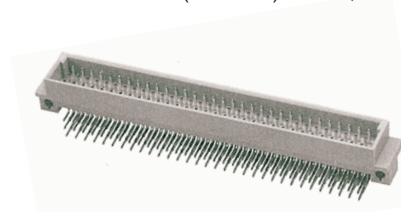

Tip	Cena	Pol	Raster
<b>M32U</b>	3,00	2 x 16 (a + c) 90°	5,08
<b>M64U</b>	4,50	2 x 32 (a + c) 90°	2,54
<b>M96U</b>	5,50	3 x 32 (a + b + c) 90°	2,54

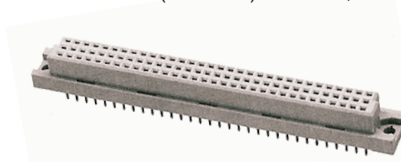

Tip	Cena	Pol	Raster
<b>Z32</b>	5,00	2 x 16 (a + c)	5,08
<b>Z64</b>	6,00	2 x 32 (a + c)	2,54
<b>Z96</b>	8,00	3 x 32 (a + b + c)	2,54



Tip	Cena	Pol	Raster
<b>Z64U</b>	7,00	2 x 32 (a + c) 90°	2,54
<b>Z96U</b>	8,00	3 x 32 (a + b + c) 90°	2,54

**KONEKTORI DIN 61612 – D (d + b + z) . . . . . UTKD**

**TEHNIČKI PODACI:**

Kontakti: zlato / nikl

Ispitni napon: 1500 V<sub>eff</sub>

Struja: 5,5A / 20°C, 4A / 70°C, 2,5A / 20°C

Stepen povećanih zahteva: 2

Ciklično uticanje: 400

Otpornost kontakata: ≤ 15mΩ

Otpor izolacije: ≥ 1011Ω

Radna temperatura: -65 ... +125°C

**MUŠKI**

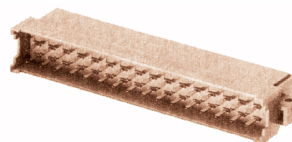
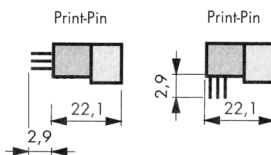
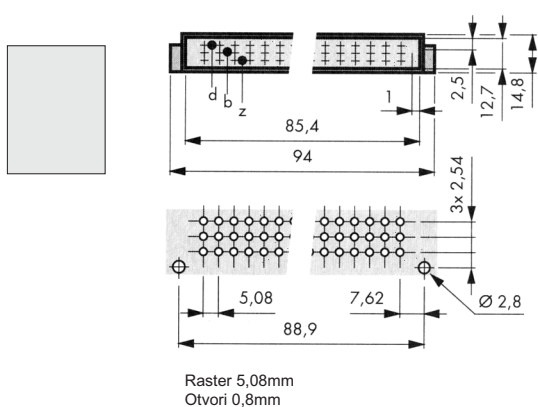

Tip	Cena	Pol	
<b>M32</b>	8,00	2 x 16	(d + z)
<b>M48</b>	10,00	3 x 16	(d + b + z)
<b>M32U</b>	8,00	2 x 16	(d + z) 90°
<b>M48U</b>	10,00	3 x 16	(d + b + z) 90°

**ZENSKI**

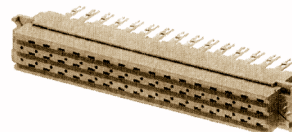
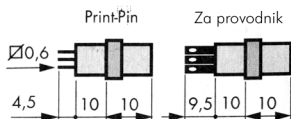
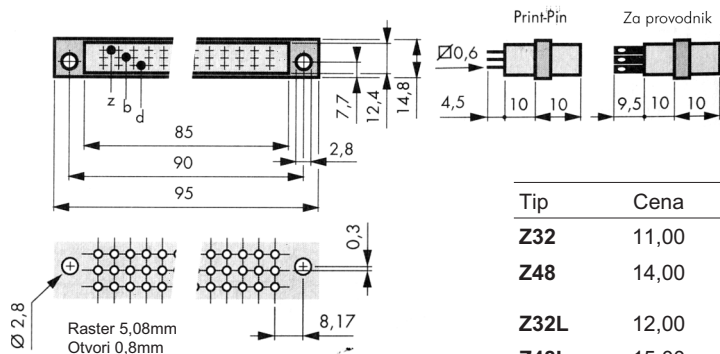

Tip	Cena	Pol	
<b>Z32</b>	11,00	2 x 16	(d + z)
<b>Z48</b>	14,00	3 x 16	(d + b + z)
<b>Z32L</b>	12,00	2 x 16	(d + z)
<b>Z48L</b>	15,00	3 x 16	(d + b + z)

**KONEKTORI DIN 41617 DL . . . . . UTKDL**

**TEHNIČKI PODACI:**

Prolazni otpor:  $5m\Omega$   
 Otpor izolacije:  $10^{12}\Omega$   
 Kapacitet između susjednih kontakata: ca. 1pF  
 Vazdušni razmak između susjednih kontakata: 1,2 mm  
 Klizni razmak između susjednih kontakata: 1,2 mm  
 Napon: 250 V  
 Max. struja po kontaktu (temp. okoline +60°C): 5 A  
 Kontaktne površine: srebro ( $4\mu$ )  
 Radna temperatura: -55 ... +125°C

**MUŠKI**

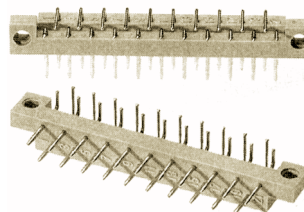
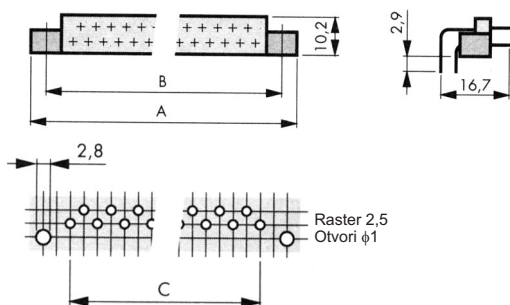

Tip	Pol	Cena	Dimenzije u mm		
			A	B	C
<b>M13</b>	13	2,20	45,8	40,0	30,0
<b>M21</b>	21	2,80	65,8	60,0	50,0
<b>M31</b>	31	3,20	90,8	85,0	75,0

**ZENSKI**

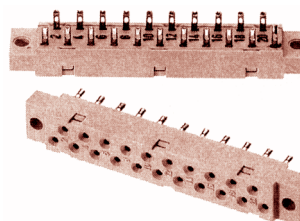
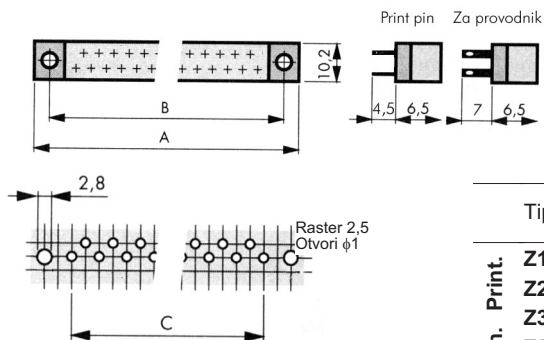

	Tip	Pol	Cena	Dimenzije u mm		
				A	B	C
<b>Lem. Print.</b>	<b>Z13</b>	13	2,80	45,8	40,0	30,0
	<b>Z21</b>	21	3,50	65,8	60,0	50,0
	<b>Z31</b>	31	4,00	90,8	85,0	75,0
	<b>Z21L</b>	21	3,50	65,8	60,0	50,0
	<b>Z31L</b>	31	4,00	90,8	85,0	75,0

**KONEKTORI DIN 41651 . . . . . UTKF**  
**KABLOVSKI . . . . . UTKFK**

**Tehnički podaci**

Izolacioni materijal:	Poliester	Struja:	1 A
Kontakti:	Mesing, niklovani	Otpor izolacije:	1000 MΩ (500V DC MIN)
Ispitni napon:	500 V AC (1 min.)	Radna temperatura:	-55... +105°C

**ZENSKI BEZ DRŽAČA**

Tip	Pol	Cena	Dimenzije u mm		
			A	B	C
10	10	1,00	17,30	6,1	10,4
14	14	1,10	22,40	6,1	10,4
16	16	1,20	24,90	6,1	10,4
20	20	1,30	30,00	6,1	10,4
26	26	1,50	37,60	6,1	10,4
34	34	2,00	47,80	6,1	10,4
40	40	2,20	55,40	6,1	10,4
50	50	3,00	68,10	6,1	10,4
60	60	3,50	80,80	6,1	10,4

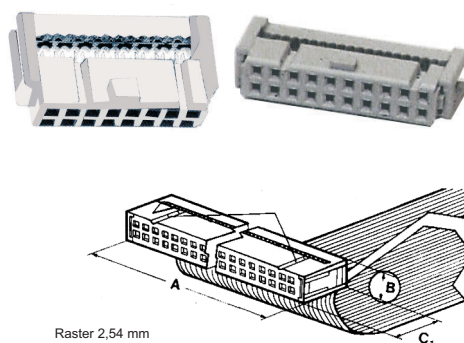

**ZENSKI SA DRŽAČEM**

Tip	Pol	Cena	Dimenzije u mm			
			A	B	C	D
D10	10	0,70	11,43	17,27	10,16	6,90
D14	14	0,80	16,51	22,40	15,24	9,44
D16	16	0,80	19,05	24,94	17,78	10,71
D20	20	0,80	24,13	30,00	22,86	13,25
D26	26	0,90	31,75	37,58	30,48	17,06
D34	34	0,90	41,91	47,80	40,64	22,14
D40	40	0,90	49,53	55,37	48,26	25,95
D50	50	1,40	62,23	68,18	60,96	32,30
D60	60	2,00	74,93	80,80	73,66	38,65
D64	64	3,00	87,63	93,61	86,37	45,00

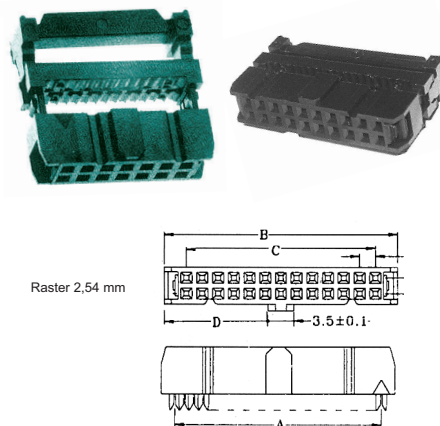

**KONEKTORI DIN 41651 – DRŽAČI . . . . . UTKFD**

Tip	Pol	Cena	Tip	Pol	Cena
10	10	0,18	34	34	0,40
14	14	0,20	40	40	0,50
16	16	0,25	50	50	0,70
20	20	0,30	60	60	1,00
26	26	0,35			





**KONEKTORI DIN 41651 . . . . . UTKF**  
**KONEKTORI DIN 41651 – KABLOVSKI . . . . . UTKFK**  
**MUŠKI SA BRAVICAMA**

**Tehnički podaci:**

Izolacioni materijal: Poliester  
 Kontakti: Mesing, niklovani  
 Ispitni napon: 500 V AC (1 min.)  
 Struja: 1 A  
 Otpor izolacije: 1000 MΩ (500V DC MIN)  
 Radna temperatura: -55... +105°C

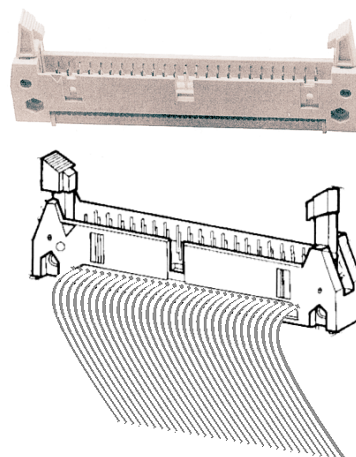
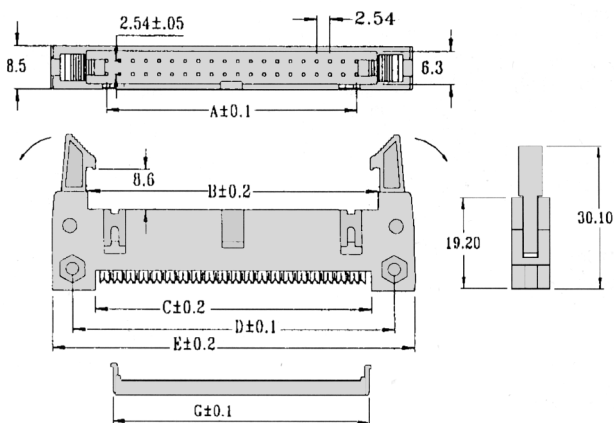

Tip	Pol	Cena	Dimenzije u mm					
			A	B	C	D	E	G
B10	10	3,00	10,16	18,00	15,30	21,85	32,17	17,20
B14	14	3,30	15,24	23,08	20,38	26,93	37,25	22,28
B16	16	3,50	17,78	25,62	22,92	29,47	39,79	24,82
B20	20	4,00	22,86	30,70	28,00	34,55	44,87	29,90
B26	26	4,50	30,48	38,32	35,62	42,17	52,49	37,52
B34	34	4,80	40,64	48,48	45,78	52,33	62,65	47,68
B40	40	5,00	48,26	56,10	53,40	59,95	70,27	55,30
B50	50	5,50	60,96	68,80	66,10	72,65	82,97	68,00

**KONEKTORI DIN 41651 . . . . . UTKF**

**KONEKTORI DIN 41651 – PRINT . . . . . UTKFP**

**Tehnički podaci**

Izolacioni materijal: Poliester  
 Kontakti: Mesing, niklovani  
 Ispitni napon: 500 V AC (1 min.)  
 Struja: 1 A

Otpor izolacije: 1000 MΩ  
 Prolazni otpor: min. 10 mΩ  
 Radna temperatura: -55... +105°C

**SA PRAVIM IZVODIMA**

Tip	Pol	Cena	Dimenzije u mm	
			A	B
10	10	0,90	20,30	10,16
14	14	1,00	25,38	15,24
16	16	1,20	27,92	17,78
20	20	1,40	33,00	22,85
26	26	1,50	40,62	30,48
34	34	1,60	50,80	40,64
40	40	1,70	58,40	48,26
50	50	1,80	71,10	60,96
60	60	2,00	83,80	73,66

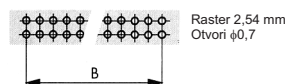
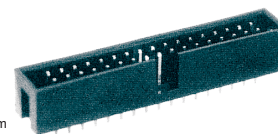
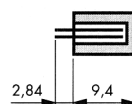
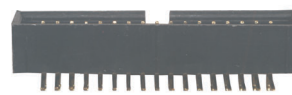
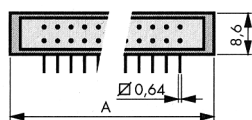

**SA IZVODIMA 90°**

Tip	Pol	Cena	Dimenzije u mm	
			A	B
U10	10	1,20	20,30	10,16
U14	14	1,40	25,38	15,24
U16	16	1,60	27,92	17,78
U20	20	1,80	33,00	22,85
U26	26	2,20	40,62	30,48
U34	34	2,40	50,80	40,64
U40	40	2,60	58,40	48,26
U50	50	2,80	71,10	60,96
U60	60	3,00	83,80	73,66

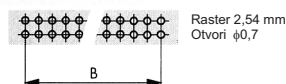
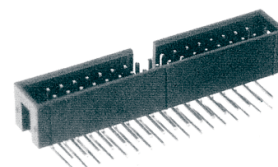
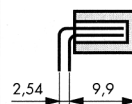
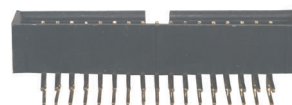
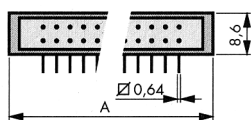

**KONEKTORI DIN 41651 . . . . . UTKF**  
**KONEKTORI DIN 41651 – PRINT . . . . . UTKFP**  
**SA PRAVIM IZVODIMA I BRAVICAMA**

Tip	Pol	Cena	Dimenzije u mm				
			A	B	C <sub>max</sub>	D	E
<b>B10</b>	10	1,50	32.2	27.9	26.8	10.16	21.8
<b>B14</b>	14	1,60	37.1	33.0	27.2	15.24	26.9
<b>B16</b>	16	1,80	39.6	35.6	27.2	17.78	29.5
<b>B20</b>	20	1,90	44.7	40.6	27.2	22.86	34.5
<b>B26</b>	26	2,20	52.3	48.3	27.2	30.48	52.3
<b>B34</b>	34	2,80	62.5	58.4	27.2	40.64	55.1
<b>B40</b>	40	3,00	70.1	66.6	27.2	48.26	59.9
<b>B50</b>	50	4,00	82.8	78.7	27.2	60.96	72.6
<b>B60</b>	60	4,50	94.7	91.4	27.2	73.66	85.3

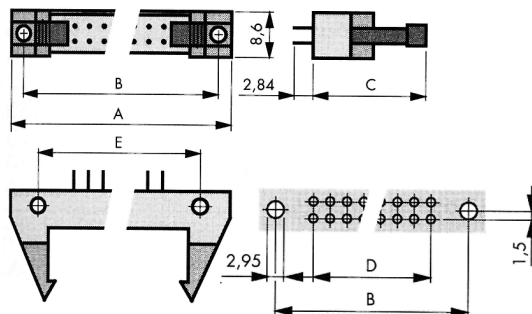
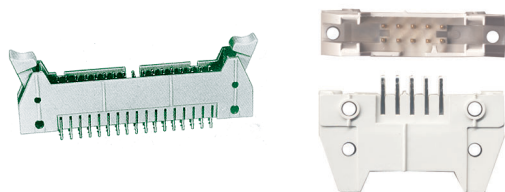

**SA IZVODIMA 90° I BRAVICAMA**

Tip	Pol	Cena	Dimenzije u mm				
			A	B	C <sub>max</sub>	D	E
<b>BU10</b>	10	2,00	32.2	27.9	26.8	10.16	21.8
<b>BU14</b>	14	2,20	37.1	33.0	27.2	15.24	26.9
<b>BU16</b>	16	2,50	39.6	35.6	27.2	17.78	29.5
<b>BU20</b>	20	2,60	44.7	40.6	27.2	22.86	34.5
<b>BU26</b>	26	2,80	52.3	48.3	27.2	30.48	52.3
<b>BU34</b>	34	3,20	62.5	58.4	27.2	40.64	55.1
<b>BU40</b>	40	3,50	70.1	66.6	27.2	48.26	59.9
<b>BU50</b>	50	4,50	82.8	78.7	27.2	60.96	72.6

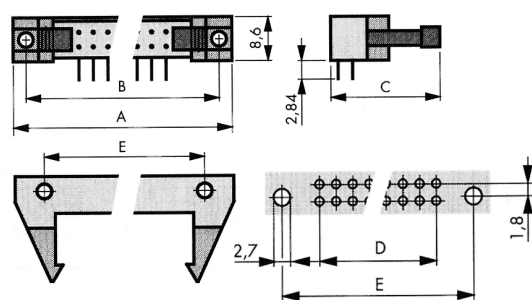
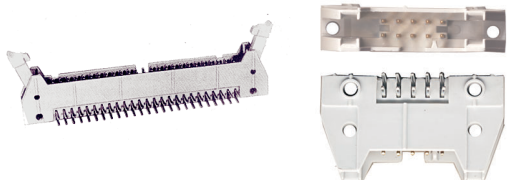

**BRAVICE . . . . . UTKFPB**

Tip	Opis	Cena
<b>M</b>	manje	0,20
<b>V</b>	veće	0,20



**NYLON KONEKTORI . . . . . UTKN**

**NYLON KONEKTORI RM 2,54 mm . . . . . UTKN2**

**Tehnički podaci**

Izolacioni materijal:	Nylon	Otpor izolacije:	min. 1000 MΩ
Radni napon:	250 V AC/DC	Prolazni otpor:	min. 10 mΩ
Ispitni napon:	1000 V AC (1 min.)	Radna temperatura:	-25... +85°C
Struja:	3 A AC/DC		

**KABLOVSKI, ZENSKI**

Tip	Pol	Cena	Dimenzije u mm	
			A	B
<b>K02</b>	2	0,10	2,54	5,60
<b>K03</b>	3	0,12	5,08	8,10
<b>K04</b>	4	0,15	7,62	10,70
<b>K05</b>	5	0,20	10,16	13,20
<b>K08</b>	8	0,25	17,78	20,80
<b>K10</b>	10	0,30	22,86	25,90
<b>K20</b>	20	0,50	48,26	50,30

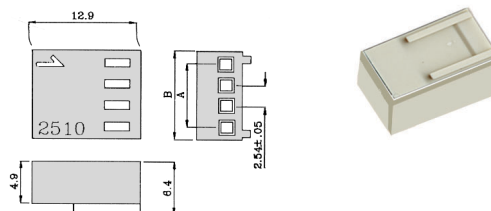

**KONTAKTNI PINOVI**

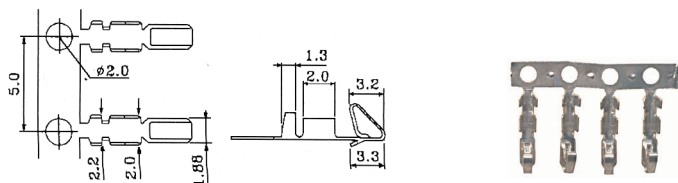

PIN Cena: 0,05

**PRINT, MUŠKI**

Tip	Pol	Cena	Dimenzije u mm	
			A	B
<b>P02</b>	2	0,15	2,54	5,60
<b>P03</b>	3	0,20	5,08	8,10
<b>P04</b>	4	0,25	7,62	10,70
<b>P05</b>	5	0,30	10,16	13,20
<b>P08</b>	8	0,40	17,78	20,80
<b>P10</b>	10	0,50	22,86	25,90
<b>P20</b>	20	0,90	48,26	50,30

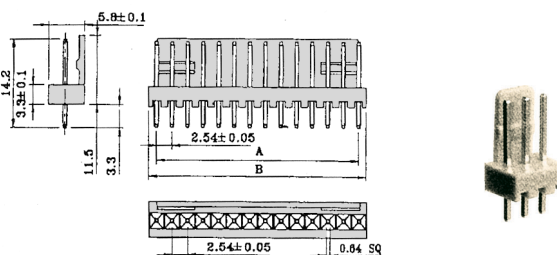

**PRINT 90°, MUŠKI**

Tip	Pol	Cena	Dimenzije u mm	
			A	B
<b>PU02</b>	2	0,15	2,54	5,60
<b>PU03</b>	3	0,20	5,08	8,10
<b>PU04</b>	4	0,30	7,62	10,70
<b>PU05</b>	5	0,35	10,16	13,20
<b>PU08</b>	8	0,50	17,78	20,80
<b>PU10</b>	10	0,60	22,86	25,90
<b>PU20</b>	20	1,00	48,26	50,30

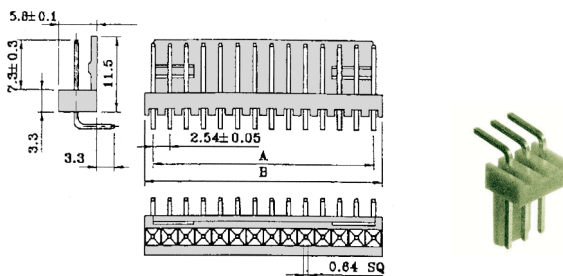

18000 Niš, Jovana Ristića 7, P.O.Box 135, Tel: 018 / 520-455, 522-814, 522-965, fax: 522-660  
<http://www.MGelectronic.co.yu> e-mail: [office@MGelectronic.co.yu](mailto:office@MGelectronic.co.yu)

**NYLON KONEKTORI . . . . . UTKN**

**NYLON KONEKTORI RM 3,96 mm . . . . . UTKN3**

**Tehnički podaci**

Izolacioni materijal:	Nylon 66	Otpor izolacije:	1 GΩ
Radni napon:	250 V AC/DC	Prolazni otpor:	min. 10 mΩ
Ispitni napon:	1500 V AC	Radna temperatura:	-25... +85°C
Struja:	7 A AC/DC		

**KABLOVSKI, ZENSKI**

Tip	Pol	Cena	Dimenzije u mm	
			A	B
<b>K02</b>	2	0,15	3,96	7,92
<b>K03</b>	3	0,20	7,92	11,88
<b>K04</b>	4	0,25	11,88	15,84
<b>K05</b>	5	0,30	15,84	19,80

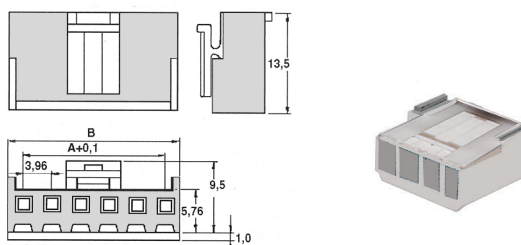

**KONTAKTNI PINOVI**

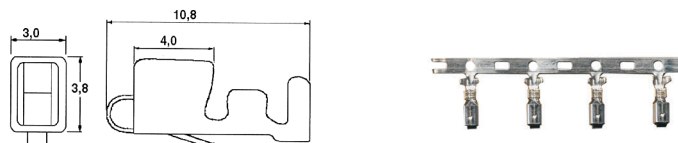

PIN Cena: 0,15

**PRINT, MUŠKI**

Tip	Pol	Cena	Dimenzije u mm	
			A	B
<b>P02</b>	2	0,25	3,96	7,92
<b>P03</b>	3	0,30	7,92	11,88
<b>P04</b>	4	0,35	11,88	15,84
<b>P05</b>	5	0,45	15,84	19,80

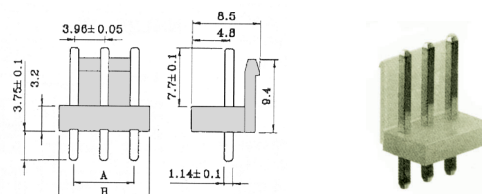

**PRINT 90°, MUŠKI**

Tip	Pol	Cena	Dimenzije u mm	
			A	B
<b>PU02</b>	2	0,30	3,96	7,92
<b>PU03</b>	3	0,35	7,92	11,88
<b>PU04</b>	4	0,45	11,88	15,84
<b>PU05</b>	5	0,55	15,84	19,80

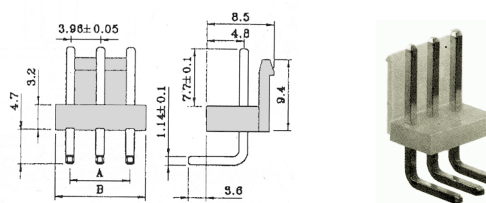

**PCB KONEKTORI . . . . . UTKPCB**

**Tehnički podaci**

Izolacioni materijal: Poliester  
 Kontakti: od bakra, kalaisani  
 Ispitni napon: 1000 V<sub>eff</sub>  
 Struja: 1 A  
 Radna temperatura: -65... +150°C

Tip	Pol	Cena	A [mm]
10	10	0,90	17,5
14	14	0,95	22,6
16	16	1,00	25,1
20	20	1,10	30,2
26	26	1,20	37,9
34	34	1,60	48,1
40	40	1,80	55,7
50	50	2,20	68,5
60	60	2,40	81,2

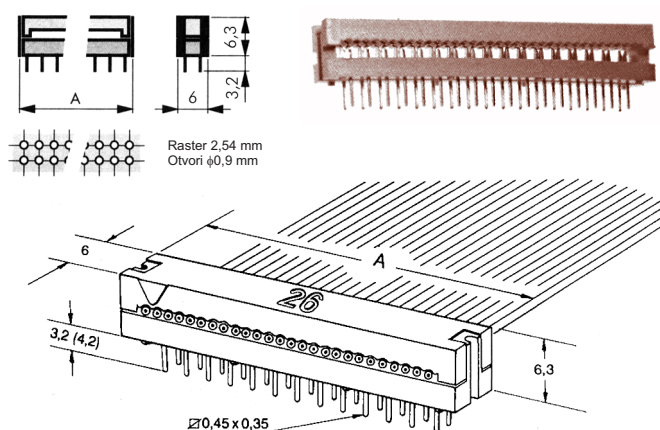

**DIP KONEKTORI . . . . . UTKDIP**

**Tehnički podaci**

Izolacioni materijal: Poliester  
 Kontakti: od bakra, kalaisani  
 Ispitni napon: 500 V AC  
 Radni napon: 250 V AC  
 Struja: 1 A  
 Otpor izolacije:  $\geq 10^{12} \Omega$   
 Radna temperatura: -65... +150°C

Tip	Pol	Cena	Dimenzije u mm				
			A	B	C	D	E
04	4	1,30	8,41	10,7	7,62	7,5	5,5
06	6	1,40	10,95	10,7	7,62	7,5	5,5
08	8	1,50	13,49	10,7	7,62	7,5	5,5
10	10	1,70	16,03	10,7	7,62	7,5	5,5
14	14	1,80	21,11	10,7	7,62	7,5	5,5
16	16	1,90	23,56	10,7	7,62	7,5	5,5
18	18	2,20	26,19	10,7	7,62	7,5	5,5
20	20	2,50	28,73	10,7	7,62	7,5	5,5
24	24	2,80	33,60	18,3	15,24	7,5	5,5
28	28	3,00	38,97	18,3	15,24	7,5	5,5
32	32	3,20	44,05	18,3	15,24	7,5	5,5
40	40	3,50	53,90	18,3	15,24	7,5	5,5

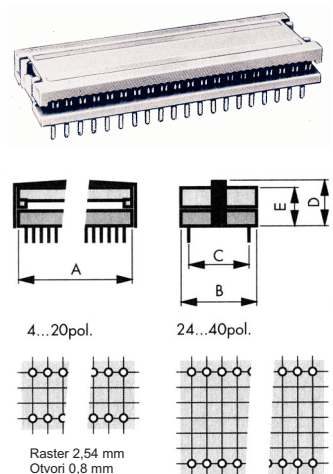



**KONTAKTNE LETVICE . . . . . UTKL**

**KONTAKTNE LETVICE – MUŠKE . . . . . UTKLM**

**Tehnički podaci**

Izolacioni materijal: Poliester UL 94 V – 0      Struja: 1 A  
 Kontakti: Mesing, cinkovani      Otpor izolacije: 1000 MΩ (500 V DC)  
 Ispitni napon: 1000 V AC (1 min.)      Radna temperatura: -55... +105°C

**JEDNOREDNE RM 2,54 mm**

Tip	Pol	Cena	Dimenzije u mm	
			A	B
1 x 36	36	0,80	91,44	88,90
1 x 40	40	1,20	101,60	99,06
1 x 50	50	2,00	127,00	124,46
1 x 50p	50	3,00	127,00	124,46

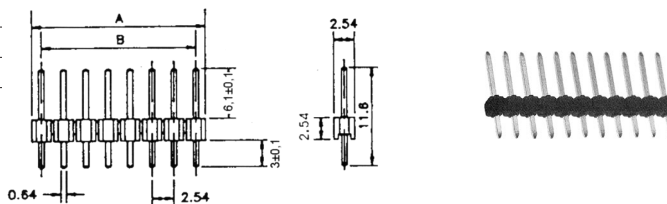

**JEDNOREDNE 90° RM 2,54 mm**

Tip	Pol	Cena	Dimenzije u mm	
			A	B
U1x36	36	1,50	91,44	88,90
U1x40	40	1,60	101,60	99,06
U1x50	50	2,20	127,00	124,46
U1x50p	50	3,50	127,00	124,46

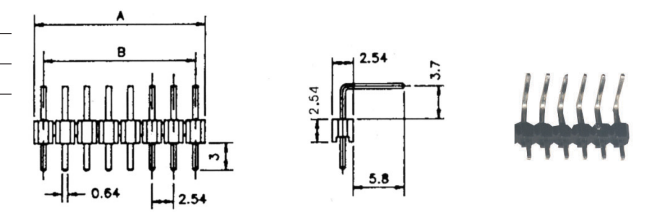

**DVOREDNE RM 2,54 mm**

Tip	Pol	Cena	Dimenzije u mm	
			A	B
2 x 36	72	1,60	91,44	88,90
2 x 40	80	1,70	101,60	99,06
2 x 50	100	4,00	127,00	124,46
2 x 50p	100	5,00	127,00	124,46

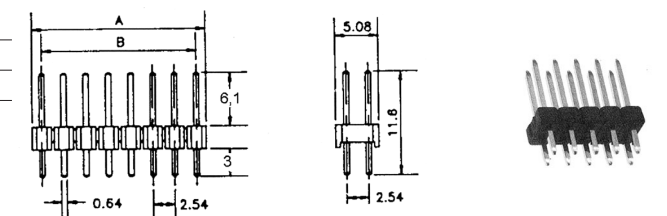

**DVOREDNE 90° RM 2,54 mm**

Tip	Pol	Cena	Dimenzije u mm	
			A	B
U2x36	72	2,50	91,44	88,90
U2x40	80	3,00	101,60	99,06
U2x50	100	5,00	127,00	124,46
U2x50p	100	6,50	127,00	124,46

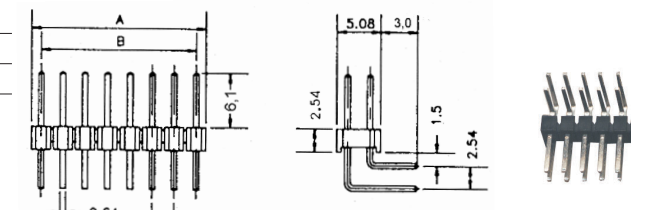

**TROREDNE RM 2,54 mm**

Tip	Pol	Cena	Dimenzije u mm	
			A	B
3 x 32	96	2,50	81,28	78,74

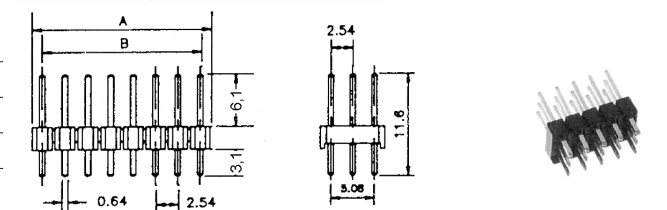

**KONTAKTNE LETVICE . . . . . UTKL**

**KONTAKTNE LETVICE – ZENSKE . . . . . UTKLZ**

**Tehnički podaci**

Izolacioni materijal:	Poliester UL 94 V – 0	Struja:	3 A
Kontakti:	Bakar, pocinkovani ili pozlaćeni	Prolazni otpor:	< 20 mΩ
Ispitni napon:	1000 V AC (1 min.)	Otpor izolacije:	> 10 <sup>9</sup> Ω
Radni napon:	250 V AC	Radna temperatura:	-55... +125°C

**JEDNOREDNE H = 5,5 mm RM 2,54 mm**

	Tip	Pol	Cena
Pocinkovane	5-1x5	5	0,90
	5-1x10	10	1,40
	5-1x15	15	1,80
	5-1x20	20	2,00
Pozlaćene	5P-1x5	5	1,10
	5P-1x10	10	1,60
	5P-1x15	15	2,00
	5P-1x20	20	2,50

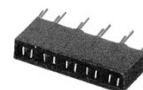
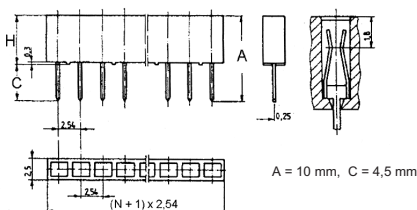

**JEDNOREDNE H = 5,5 mm RM 2,54 mm 90°**

	Tip	Pol	Cena
Pozlaćene	5U-1x5	5	1,70
	5U-1x10	10	3,40
	5U-1x15	15	3,80
	5U-1x20	20	4,80

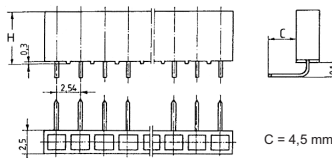

**JEDNOREDNE H = 8,5 mm RM 2,54 mm**

	Tip	Pol	Cena
Pocink.	8-1x5	5	0,90
	8-1x10	10	1,20
	8-1x20	20	2,00
Pozl.	8P-1x5	5	1,20
	8P-1x10	10	1,80
	8P-1x20	20	3,50

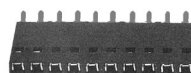
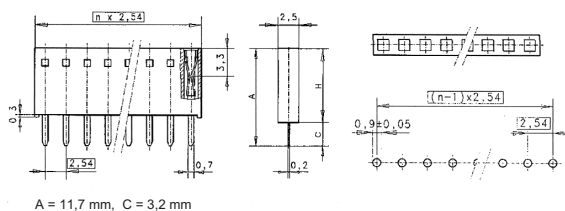

**DVOREDNE H = 8,5 mm RM 2,54 mm**

	Tip	Pol	Cena
Pocink.	8-2x10	20	2,00
	8-2x20	40	4,20
Pozl.	8P-2x10	20	3,50
	8P-2x20	40	6,50

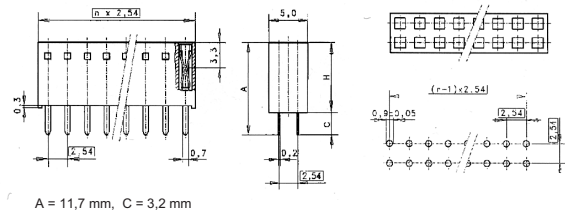

18000 Niš, Jovana Ristića 7, P.O.Box 135, Tel: 018 / 520-455, 522-814, 522-965, fax: 522-660  
<http://www.MGelectronic.co.yu> e-mail: [office@MGelectronic.co.yu](mailto:office@MGelectronic.co.yu)

**KONTAKTNE LETVICE . . . . . UTKL**

**KONTAKTNE LETVICE – PROFESIONALNE- . . . . . UTKLP**

**Tehnički podaci**

Izolacioni materijal:	Poliester UL 94 V – 0	Struja:	3 A
Kontakti:	Mesing, nikl i pozlata	Prolazni otpor:	10 mΩ
Ispitni napon:	1000 V AC (1 min.)	Otpor izolacije:	> 10000 MΩ
Radni napon:	100 V RMS / 150 V DC	Radna temperatura:	-55... +125°C

**JEDNOREDNE H = 6,9 mm RM 2,54 mm**

Tip	Pol	Cena
1 x 5	5	0,90
1 x 10	10	1,80
1 x 20	20	3,40
1 x 36	36	3,80

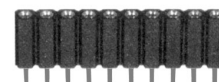
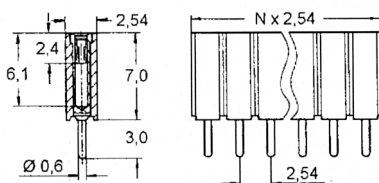

**DVOREDNE H = 6,9 mm RM 2,54 mm**

Tip	Pol	Cena
2 x 10	20	3,40
2 x 20	40	6,80
2 x 36	72	8,00

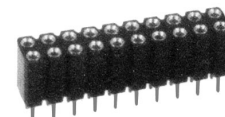
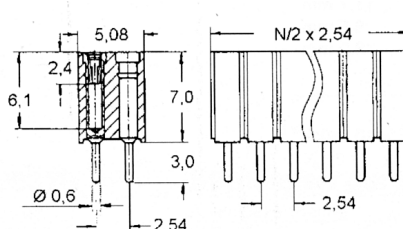

**KRATKOSPOJNICI – JUMPERI RM 2,54 mm . . . . . UTKLK**

Tip	Opis	Cena
Zatvoreni	ZCR crveni	0,15
	ZCN crni	0,15
Otvoreni	OCR crveni	0,15
	OCN crni	0,15

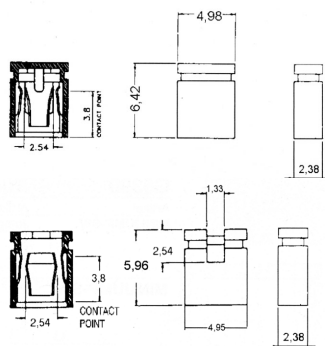

**DIMENZIJE**

**UTDINM**

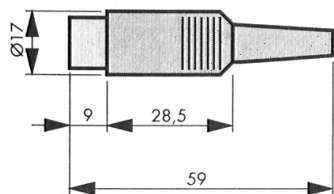

**UTDINZ**

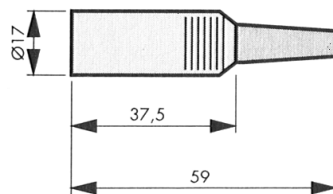

**UTDINU**

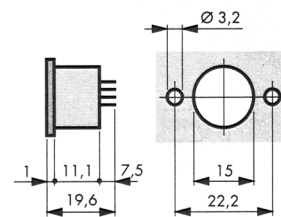

**UTCIOUS**

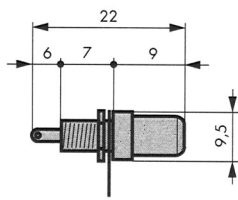

**UTCIOUSP**

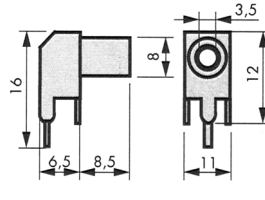

**UTBAU63SS**

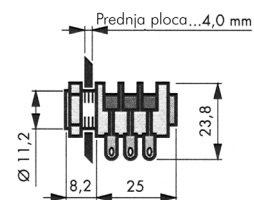

**UTBAV25M**

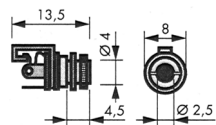

**UTBAU35SP**

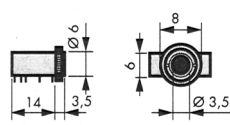

**UTBAU63**

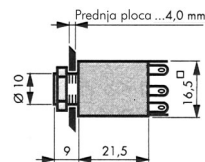

Typ S2 BBB Printmontage

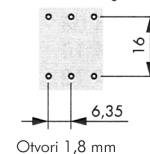

**UTZVZS**

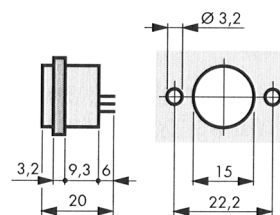

**UTZVMK**

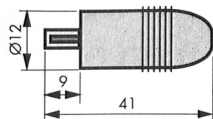

**UTZVZK**

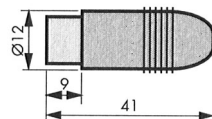

**UTSCAUS**

