

ALAT **AI**

ODVIJAČI
KLEŠTA
PINCETE
NOZEVI ZA BLANKIRANJE
LEMILICE
VAKUM PUMPE
MINI BUŠILICE
PIŠTOLJI
TURPIJE
STEGE
DRZAČI ZA ŠTAMPANE PLOČE
LUPE
TELESKOP OGLEDALA
TESTERICA
ŠTIMERI
SKALPELI
FLOMASTERI



ODVIJAČI ALO
SERIJA 400I - ELEKTRIČARSKI (SA IZOLACIJOM) ALO400I

Tip	Cena	Dimenzije u mm					
		A	B	C	D	E	G
1	6,00	0,4	2,5	2,5	75	80	155
2	8,00	0,8	4,0	3,5	100	90	190
3	9,00	1,0	5,5	5,0	125	100	225
4	13,00	1,2	6,5	6,0	150	110	260

Chrom vanadium - molibden * Din 5264-A / 5265 * ISO 2380

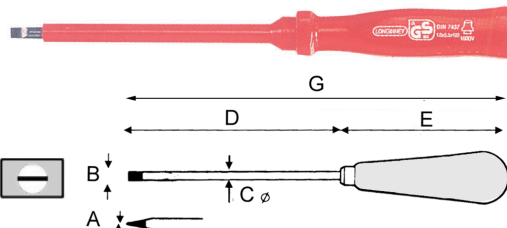

SERIJA 420I - PH PHILLIPS (SA IZOLACIJOM) ALO420I

Tip	Cena	Dimenzije u mm				
		PH NO.	C	D	E	G
1	9,00	1	4,5	80	90	170
2	13,00	2	6,0	100	100	200

Chrom vanadium - molibden * Din 5264-A / 5265 * ISO 2380

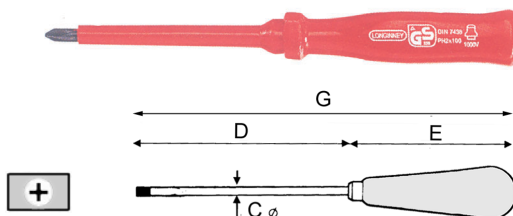

SERIJA 500 - MEHANIČARSKI ALO500

Tip	Cena	Dimenzije u mm					
		A	B	C	D	E	G
1	6,00	0,5	3,0	3,0	80	85	165
2	7,00	0,8	4,0	4,0	100	90	190
3	9,00	1,0	5,5	5,0	125	100	225
4	12,00	1,2	6,5	6,0	150	110	260
5	16,00	1,2	8,0	7,0	175	120	295
6	18,00	1,6	10,0	9,0	200	120	320

Chrom vanadium - molibden * Din 5264-A / 5265 * ISO 2380

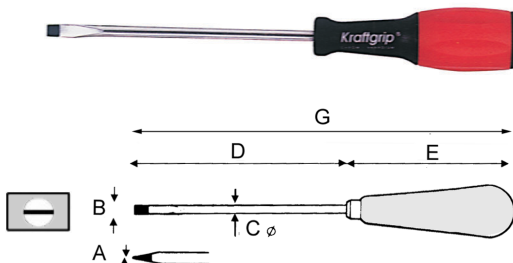

SERIJA 510 - ELEKTRONIČARSKI ALO510

Tip	Cena	Dimenzije u mm					
		A	B	C	D	E	G
1	7,00	0,5	3,0	3,0	100	85	185
2	8,00	0,8	4,0	4,0	125	90	215
3	11,00	1,0	5,5	5,0	150	100	250
4	14,00	1,2	6,5	6,0	200	120	320

Chrom vanadium - molibden * Din 5264-A / 5265 * ISO 2380

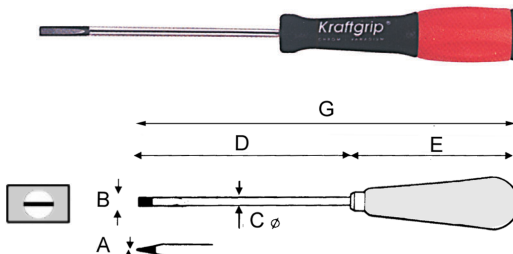

18000 Niš, Jovana Ristića 7, P.O.Box 135, Tel: 018 / 520-455, 522-814, 522-965, fax: 522-660
http://www.MGelectronic.co.yu e-mail: office@MGelectronic.co.yu

ALAT

AL

ODVIJAČI ALO
SERIJA 520 - PH PHILLIPS ALO520

Tip	Cena	Dimenzije u mm				
		PH NO.	C	D	E	G
0	7,00	0	3,0	60	80	145
1	8,00	1	4,0	80	100	180
2	11,00	2	5,0	100	110	210
3	14,00	3	6,0	150	120	270

Chrom vanadium - molibden * Din 5264-A / 5265 * ISO 2380

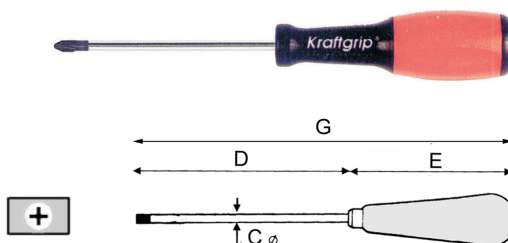

SERIJA 530 - PZ POZIDRIV ALO530

Tip	Cena	Dimenzije u mm				
		PZ	C	D	E	G
0	9,00	0	3,0	60	85	145
1	11,00	1	4,5	80	100	180
2	14,00	2	6,0	100	110	210

Chrom vanadium - molibden * Din 5264-A / 5265 * ISO 2380

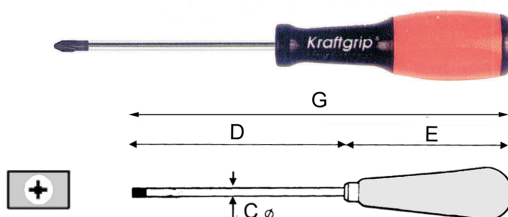

SERIJA 540 - KRATKI ALO540

Tip	Cena	Dimenzije u mm					
		A	B	C	D	E	G
1	9,00	1,2	6,5	6,5	25	60	85

Chrom vanadium - molibden * Din 5264-A / 5265 * ISO 2380

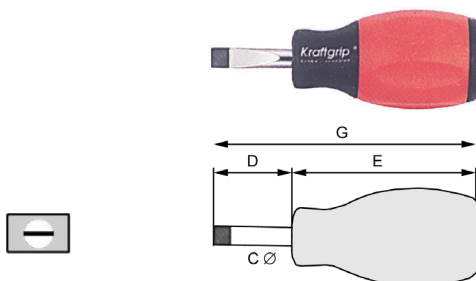

SERIJA 541 - PH PHILLIPS (KRATKI) ALO541

Tip	Cena	Dimenzije u mm				
		PH NO.	C	D	E	G
2	10,00	2	6,0	25	60	85

Chrom vanadium - molibden * Din 5264-A / 5265 * ISO 2380

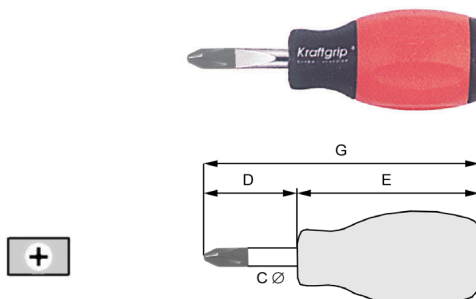

ODVIJAČI ALO
SERIJA 560 -TORX ALO560T

Tip	Cena	Dimenzije u mm					
		TORX	C	D	E	G	
6	8,00	T6 H6	3,0	60	85	145	
7	8,00	T7 H7	3,0	60	85	145	
8	8,00	T8 H8	3,0	60	85	145	
9	8,00	T9 H9	3,0	60	85	145	
10	8,00	T10 H10	3,0	80	85	165	

Chrom vanadium - molibden * Din 5264-A / 5265 * ISO 2380

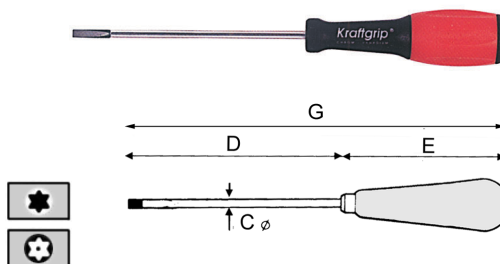

SERIJA 580 - NASADNI ALO580

Tip	Cena	Dimenzije u mm					
		Navoj	H	C	D	E	G
5	10,00	M3,0	5,0	4,0	70	80	150
6	10,00	M3,5	6,0	4,0	70	80	150
7	11,00	M4,0	7,0	4,0	70	80	150
8	12,00	M4,5	8,0	4,0	70	80	150
9	12,00	M5,0	9,0	4,0	70	80	150
10	12,00	M5,5	10	4,0	70	80	150

Chrom vanadium * Din 5264-A / 5265 * ISO 2380

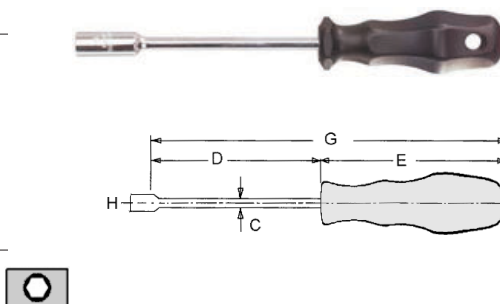

SERIJA 800L - IMBUS ALO800L

Tip	Cena	Dimenzije u mm					
		IMBUS	A	B	C	D	E
2,5	6,00	2,5	15	125	30	45	155
3	6,00	3,0	15	125	30	45	155
3,5	7,00	3,5	15	125	30	45	155
4	7,00	4,0	15	125	30	45	155
4,5	8,00	4,5	20	150	35	70	185
5	8,00	5,0	20	150	35	70	185

Chrom vanadium - molibden * Din 5264-A / 5265 * ISO 2380

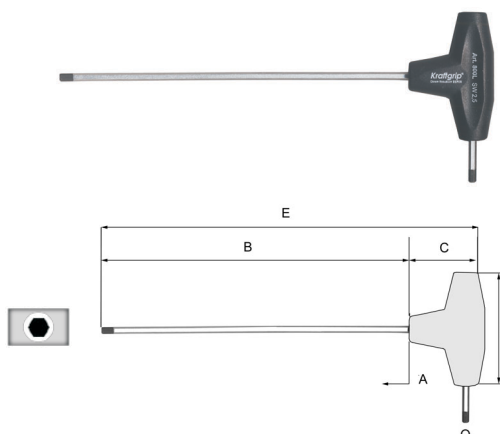

18000 Niš, Jovana Ristića 7, P.O.Box 135, Tel: 018 / 520-455, 522-814, 522-965, fax: 522-660
http://www.MGelectronic.co.yu e-mail: office@MGelectronic.co.yu

ODVIJAČI ALO
ISPITIVAČI NAPONA ALOIN



01 220V 3,00

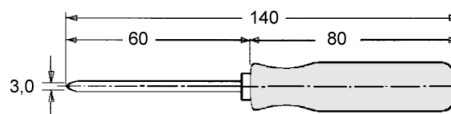

02 220V 4,00

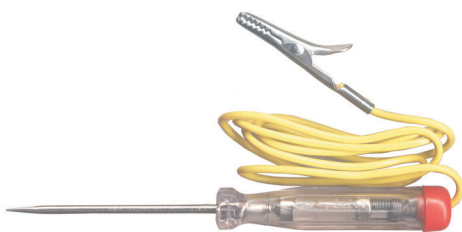
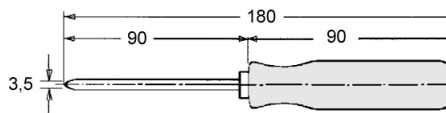

03 6-24V 6,00

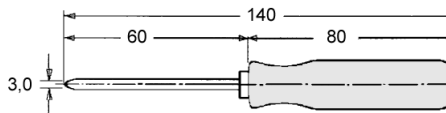

ALAT



AL

ODVIJAČI ALO

KOMPLETI ODVIJAČA 00 · · ALOK00

KOMPLETI ODVIJAČA 01 · · ALOK01



-  1,0; 1,2; 1,6; 2,0 mm
-  PH 0; PH 1



A Cena: 8,00



-  1,0; 1,2; 1,6; 2,0; 2,4; 3,0 mm



A Cena: 8,00



-  1,0; 1,2; 1,4; 1,8; 2,4; 3,0 mm
-  PH 0000; PH 000; PH 00; PH 0; PH 1



B Cena: 20,00



-  1,0; 1,6; 2,4; 3,0 mm
-  PH 0; PH 1



B Cena: 8,00



-  1,0; 1,4; 2,0; 2,4; 3,0; 3,8 mm
-  PH 0000; PH 000; PH 00; PH 0

C Cena: 12,00





-  1,4; 1,8; 2,3 mm
-  PH 00; PH 0; PH 1

C Cena: 16,00



18000 Niš, Jovana Ristića 7, P.O.Box 135, Tel: 018 / 520-455, 522-814, 522-965, fax: 522-660
<http://www.MGelectronic.co.yu> e-mail: office@MGelectronic.co.yu

ODVIJAČI ALO
KOMPLETI ODVIJAČA 02 ALOK02

-  2,4; 3,0; 4,0 mm
-  PH 00; PH 0; PH 1



A Cena: 9,00

-  2,4; 3,0; 4,0 mm
-  PH 00; PH 0; PH 1





B Cena: 26,00

-  0,8; 1,2; 1,6; 2,0; 2,4; 3; 3,5 mm



C Cena: 28,00

-  1,4; 2,0; 2,4; 3,0 mm
-  PH 000; PH 00; PH 0



D Cena: 28,00

-  TX 5; TX 6; TX 7; TX 8;
TX 9; TX 10; TX 15



E Cena: 32,00

ODVIJAČI ALO
KOMPLETI ODVIJAČA 03 ALOK03



* CHROM VANADIUM



- * 0,5 x 3,0 x 80 mm
- * 1,0 x 5,5 x 125 mm
- * 1,2 x 6,5 x 150 mm



- * PH 1 x 80
- * PH 2 x 100

A Cena: 24,00



* CHROM VANADIUM
AC 1000V



- * 0,5 x 3,0 x 80 mm
- * 0,8 x 4,0 x 100 mm
- * 1,0 x 5,0 x 125 mm
- * 1,2 x 7,0 x 150 mm



- * PH 1 x 80
- * PH 2 x 100
- ISPITIVAČ NAPONA

B Cena: 34,00



* CHROM VANADIUM-MOLYBDEN



- * 0,5 x 3,0 x 80 mm
- * 1,0 x 5,5 x 125 mm
- * 1,2 x 6,5 x 150 mm



- * PH 0 x 60 mm
- * PH 1 x 80 mm
- * PH 2 x 100 mm

C Cena: 52,00



ODVIJAČI ALO
KOMPLETI ODVIJAČA 04 ALOK04

* CHROM VANADIUM
SA IZOLACIJOM AC 500V



* 0,4 x 2,5 x 75 mm
* 0,8 x 4,0 x 100 mm
* 1,0 x 5,5 x 125 mm



* PH 1 x 80
* PH 2 x 100

A Cena: 12,00



* CHROM VANADIUM
SA IZOLACIJOM AC 500V



* 0,4 x 2,5 x 75 mm
* 0,8 x 4,0 x 100 mm
* 1,0 x 5,5 x 125 mm
* 1,2 x 6,5 x 150 mm



* PH 0 x 60
* PH 1 x 80
* PH 2 x 100
ISPITIVAČ NAPONA

B Cena: 18,00



* CHROM VANADIUM
SA IZOLACIJOM AC 1000V



* 0,4 x 2,5 x 75 mm
* 0,8 x 4,0 x 100 mm
* 1,0 x 5,5 x 125 mm
* 1,2 x 6,5 x 150 mm



* PH 1 x 80
* PH 2 x 100
ISPITIVAČ NAPONA

C Cena: 38,00



ODVIJAČI ALO

KOMPLET ODVIJAČA 05 ALOK05



- * 0,5 x 3,0 x 50 mm
- * 0,8 x 4,0 x 75 mm
- * 1,0 x 5,0 x 95 mm
- * 1,2 x 7,0 x 105 mm



- * PH 0 x 80
- * PH 1 x 100
- * PH 2 x 95



Cena: 28,00

KOMPLET ODVIJAČA 06 ALOK06



- * 0,5 x 4,0 x 80 mm
- * 0,8 x 6,0 x 80 mm
- * 1,0 x 7,5 x 100 mm
- * 1,2 x 8,5 x 150 mm



- * PH 1 x 75
- * PH 2 x 100



- * KOMBINOVANI, NASADNI
- * NORMAL
- * PHILIPS
- * POZDRIV
- * IMBUS
- * TORX
- * HEKSAGON

Cena: 46,00



18000 Niš, Jovana Ristića 7, P.O.Box 135, Tel: 018 / 520-455, 522-814, 522-965, fax: 522-660
<http://www.MGelectronic.co.yu> e-mail: office@MGelectronic.co.yu

ODVIJAČI ALO

ODVIJAČ I - IMBUS (KOMPLET) ALOIM



4402 Komplet 8 kom. MM12,00
07; 09; 1,27; 1,5; 2; 2,5; 3; 4 mm



4411 Komplet 7 kom. MM12,00
1,5; 2; 2,5; 3; 4; 5; 6 mm
4412 Komplet 8 kom. INCH 15,00
1/16; 5/64; 3/32; 1/8; 5/32; 3/16; 7/32; 1/4 inch



4421 Komplet 6 kom. MM24,00
2; 2,5; 3; 4; 5; 6 mm



4441 Komplet 8 kom. MM24,00
2; 2,5; 3; 4; 5; 6; 7; 8 mm
4442 Komplet 8 kom. INCH 24,00
5/64; 3/32; 1/8; 5/32; 3/16; 7/32; 1/4; 5/16 inch

ALAT

AL

KLEŠTA ALKL
KLEŠTA, SERIJA PK ALKLPK

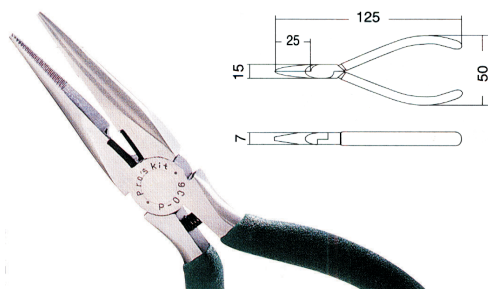

036 ŠPICASTA 125 mm 16,00

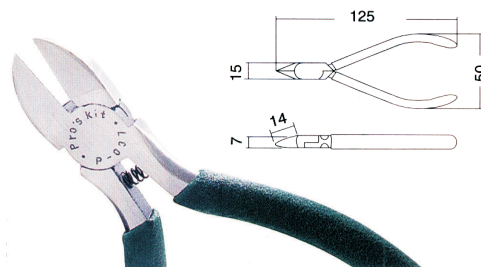

037 SEČICE, ŠIRE 125 mm 16,00

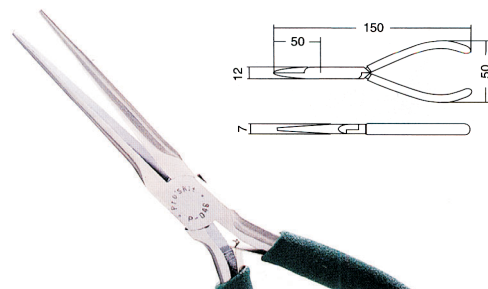

046 ŠPICASTA 150 mm 16,00

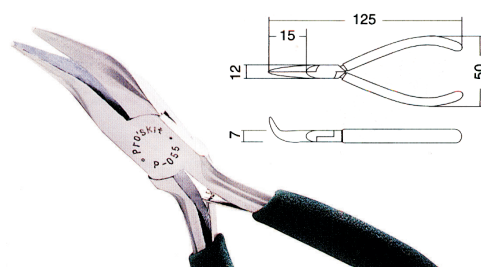

055 ŠPICASTA KRIVA 125 mm 16,00

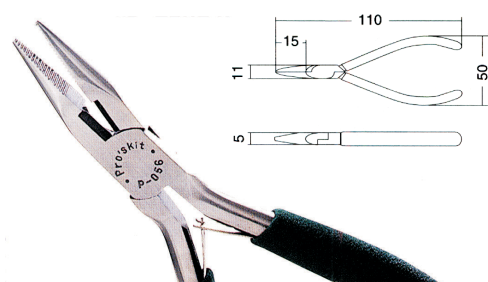

056 ŠPICASTA 110 mm 16,00

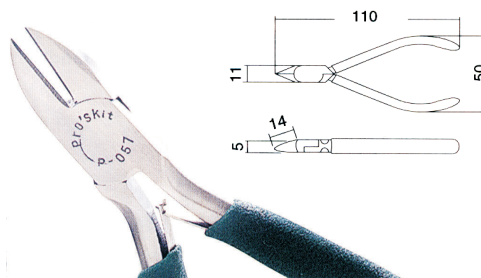

057 SEČICE, UzE 110 mm 16,00

ALAT

AL

KLEŠTA ALKL
KLEŠTA, SERIJA 6000 ALKL6



001 RAVNA 130 mm 28,00



002 SEČICE 105 mm 28,00



003 ŠPICASTA, KRAĆA
120 mm 28,00



004 ŠPICASTA, DUŽA
120 mm 28,00



005 ŠPICASTA, KRIVA
120 mm 28,00



006 SEČICE 120 mm 28,00

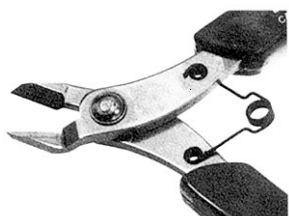

007 SEČICE 120 mm 28,00



ALAT

AL

KLEŠTA ALKL
KLEŠTA, STANDARDNA ALKLST

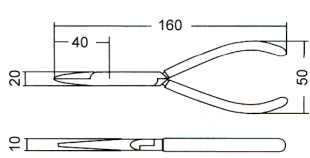

R RAVNA 22,00

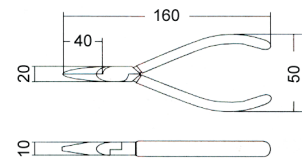

S ŠPICASTA 22,00

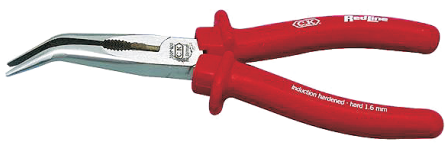
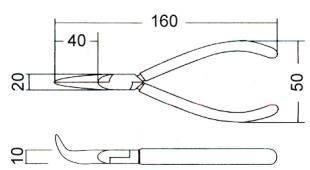

K KRIVA 22,00

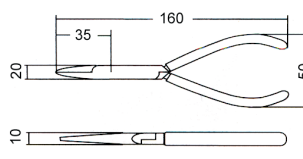

O OKRUGLA 22,00

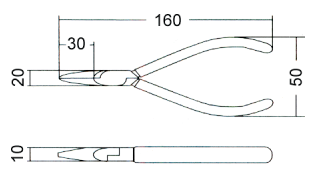

U UNIVERZALNA 22,00

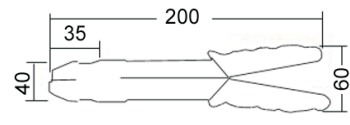

P POSEBNA, SPECIJALNA 18,00

18000 Niš, Jovana Ristića 7, P.O.Box 135, Tel: 018 / 520-455, 522-814, 522-965, fax: 522-660
<http://www.MGelectronic.co.yu> e-mail: office@MGelectronic.co.yu

ALAT

AL

KLEŠTA ALKL

KLEŠTA SA IZOLACIJOM 1000V ALKLI

052A

UNIVERZALNA
 IZOLACIJA 1000 V

Cena: 24,00

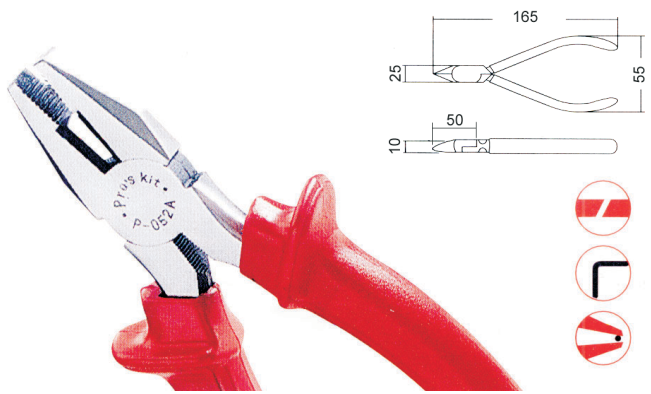

067A

SEČICE
 IZOLACIJA 1000 V

Cena: 24,00

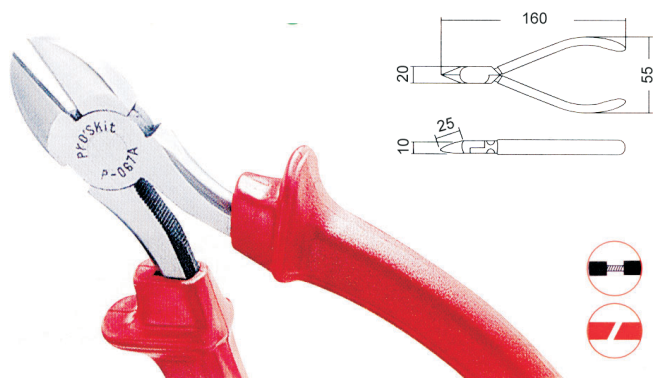

709A

ŠPICASTA
 IZOLACIJA 1000 V

Cena: 24,00

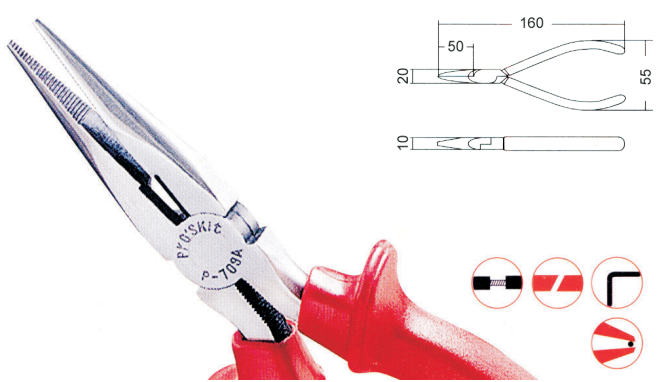

KLEŠTA ALKL
KLEŠTA ZA SEČENJE (SEČICE) ALKLSE

01

HT109

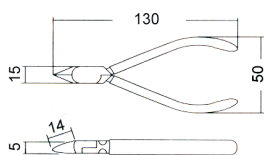

Cena: 11,00



02

HT222

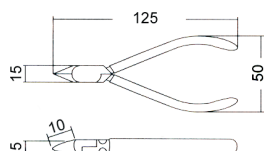

Cena: 18,00



03

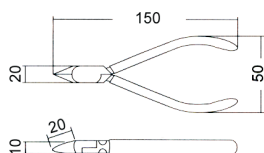

Cena: 22,00



04

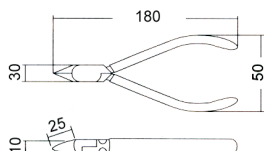

Cena: 36,00



KLEŠTA ALKL

KLEŠTA ZA BLANKIRANJE ALKLB

01

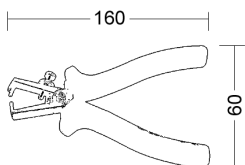

Cena: 24,00

02

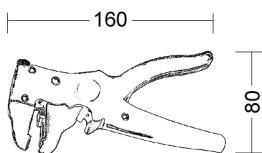

Cena: 9,00

03

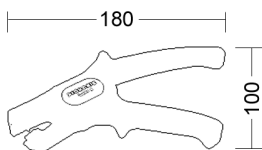

Cena: 46,00

04

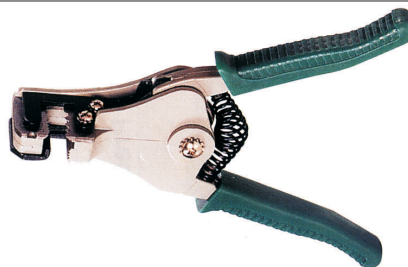
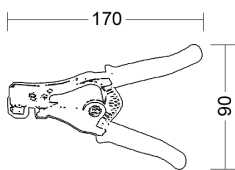

Cena: 58,00

05

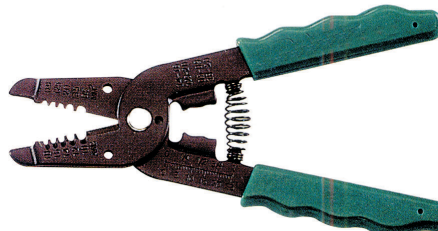
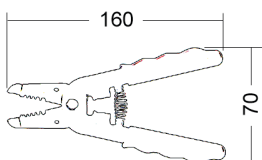

Cena: 28,00

ALAT

AL

KLEŠTA ALKL

KLEŠTA ZA KRIMPOVANJE ALKLC

HT102H

ZA F KONEKTORE
ZA KABLOVE
RG 59 / 62 / 6

Cena: 28,00

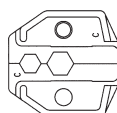

HT202B

ZA KABLOVSKJE STOPICE
0,08 - 2 mm²

AWG 10-12, 14-16, 18-20
mm² 6; 2,5; 1,5 (JIS)

Cena: 28,00

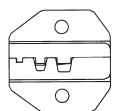

HT214

ZA KONEKTORE
ZA FLET KABLOVE

Cena: 48,00

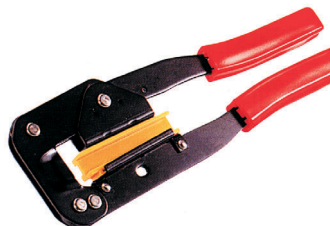
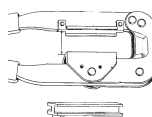
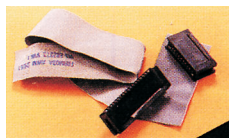

HT230

ZA KONEKTORE
ZA KABLOVE RG 58 / 59 / 6

6,3 mm φ, 5,18 mm φ, 2,29 mm φ,
1,72 mm φ, 7,9 mm φ

Cena: 78,00

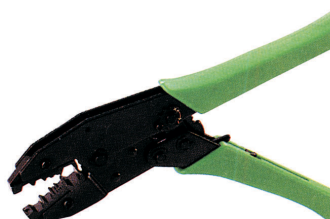
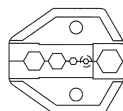

HT230C

ZA KABLOVSKJE STOPICE
0,5 - 5,2 mm

AWG 10-12, 14-16, 18-20
mm² 6; 2,5; 1,5 (JIS)

Cena: 76,00

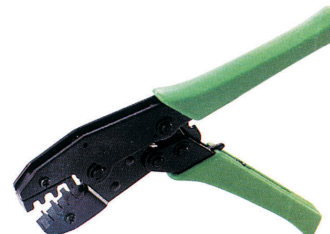
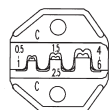
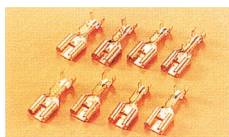

ALAT

AL

KLEŠTA ALKL

KLEŠTA ZA KRIMPOVANJE ALKLC

HT301H

ZA KABLOVSKÉ STOPICE
SA IZOLACIJOM

AWG 10-12, 14-16, 18-20
mm² 6; 2,5; 1,5 (JIS)

Cena: 72,00

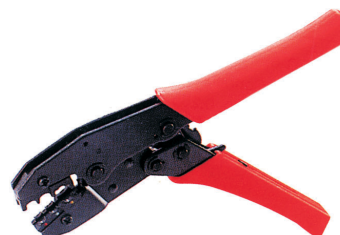
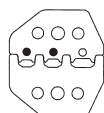
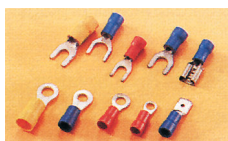

HT301C

ZA KONEKTORE ZA
KABLOVE RG 58 / 59 / 62 / 6

6,5 mm ϕ , 8,1 mm ϕ ,
1,72 mm ϕ , 5,41 mm ϕ

Cena: 78,00

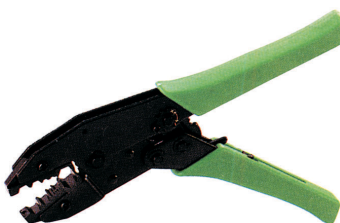
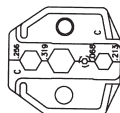

HT301E

ZA KABLOVSKÉ STOPICE
0,5 - 4 mm²
SA I BEZ IZOLACIJE

AWG 22, 20, 18, 16, 14, 12
mm² 0,5; 0,75; 1; 1,5; 2,5; 4

Cena: 76,00

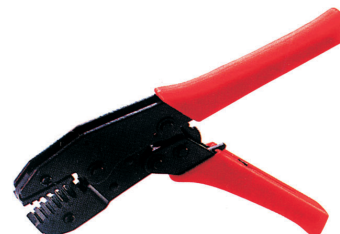
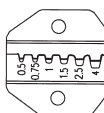

HT301S

ZA KABLOVSKÉ STOPICE
5,2 - 16 mm²
SA I BEZ IZOLACIJE

AWG 10-12, 14-16, 18-20
mm² 6; 2,5; 1,5 (JIS)

Cena: 78,00

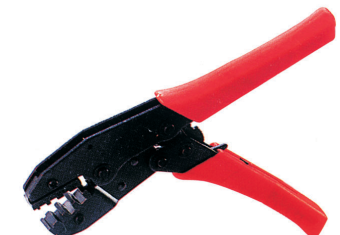
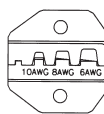
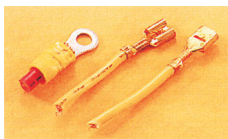

HT301U

ZA KONTAKTNE PINOVE
KONEKTORA

AWG 10-12
mm² 5,5 - 1,5 (JIS)

Cena: 82,00

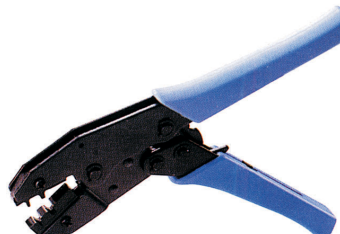
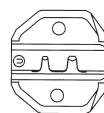
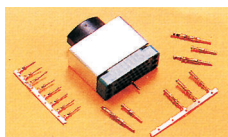

ALAT

AL

KLEŠTA ALKL

KLEŠTA ZA TELEFONE ALKLT

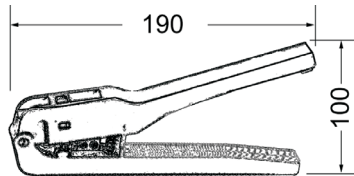

PLASTIČNA

02 ZA UTIKAČE 4/4 (RJ9) 12,00

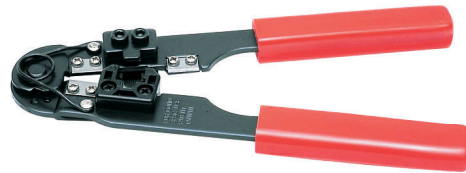
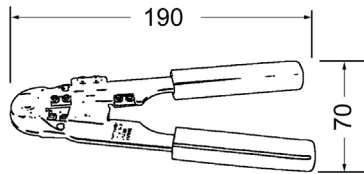

METALNA

04 ZA UTIKAČE 4/4 (RJ9) 32,00
06 ZA UTIKAČE 6/4 (RJ11), 6/6 (RJ12) 34,00
08 ZA UTIKAČE 8/8 (RJ45) 38,00

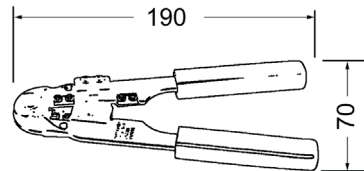

UNIVERZALNA

U6/8 ZA UTIKAČE 6/6 (RJ12), 8/8 (RJ45) 76,00

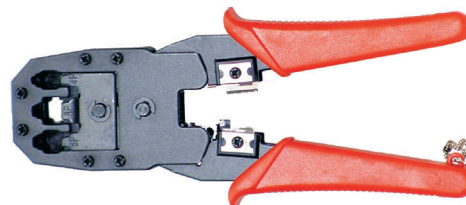
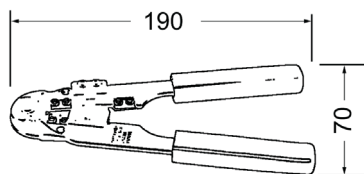

UNIVERZALNA

U4/6/8 ZA UTIKAČE 4/4 (RJ9), 6/4 (RJ11), 8/8 (RJ45) 118,00

18000 Niš, Jovana Ristića 7, P.O.Box 135, Tel: 018 / 520-455, 522-814, 522-965, fax: 522-660
<http://www.MGelectronic.co.yu> e-mail: office@MGelectronic.co.yu

ALAT

AL

KLEŠTA ALKL
KOMPLETI KLEŠTA ALKLK

RAVNA KLEŠTA
ŠPICASTA KLEŠTA
SEČICE



KOMPLET 1 130mm Cena: 28,00

RAVNA KLEŠTA
ŠPICASTA KLEŠTA
ŠPICASTA KRIVA KLEŠTA
OKRUGLA KLEŠTA
SEČICE



KOMPLET 2 130mm Cena: 42,00

RAVNA KLEŠTA
ŠPICASTA KLEŠTA
ŠPICASTA KRIVA KLEŠTA
OKRUGLA KLEŠTA
SEČICE



KOMPLET 3 160mm Cena: 48,00

ALAT

AL

PINCETE ALPI

PRAVE, STANDARDNE (160 mm)

01

Cena: 5,00



KRIVE, STANDARDNE (160 mm)

02

Cena: 6,00



ANTI-STATIC (110 mm)

101 T

Cena: 9,00

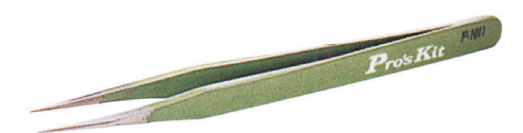

PRAVE, PRECIZNE (110 mm)

102 T

Cena: 9,00



KRIVE, PRECIZNE (110 mm)

104 T

Cena: 9,00



PRAVE, PRECIZNE, DUZE (140 mm)

105 T

Cena: 9,00



KRIVE, DUZE, MAGNETNE (140 mm)

106 T

Cena: 10,00



PINCETE ALPI

UKRŠTENE, REVERZNE, MEGNETNE (160 mm)

108 T

Cena: 10,00



UGAONE, PRECIZNE (115 mm)

110 T

Cena: 10,00



UKRŠTENE, KRIVE OJAČANE (160 mm)

117 T

Cena: 9,00

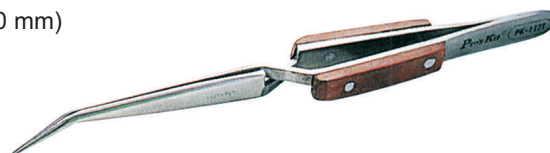

UKRŠTENE, PRAVE , OJAČANE (160 mm)

118T

Cena: 9,00

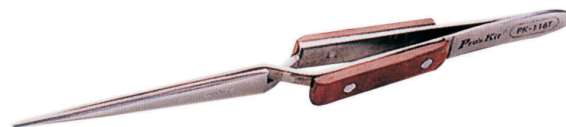

PRAVE , OJAČANE DUZE (200 mm)

119T

Cena: 9,00



PRAVE, SNAZNE (160 mm)

123T

Cena: 11,00



ALAT

AL

PINCETE ALPI

ZA IC KOLA

IC

Cena: 6,00



ZA PLCC IC KOLA

PLCC

Cena: 22,00



KOMPLET SA IZOLACIJOM

KI

Cena: 9,00



KOMPLET, PLASTIČNE

KP

Cena: 24,00



KOMPLET, METALNE

KM

Cena: 24,00



FEDER, FLEKSIBILNE

F

Cena: 12,00



NOZEVI ZA BLANKIRANJE ALNB



AWM16 22,00



AWM28 24,00

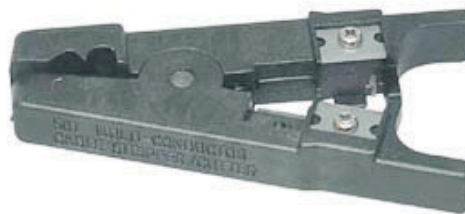
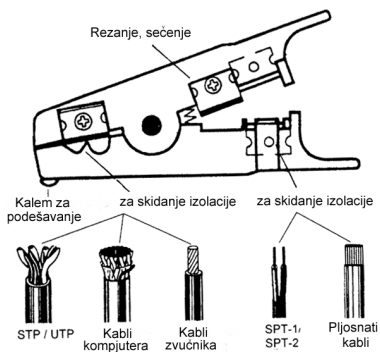

AWZ501 32,00

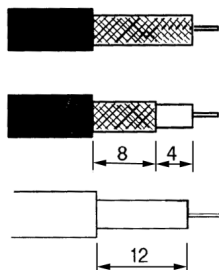
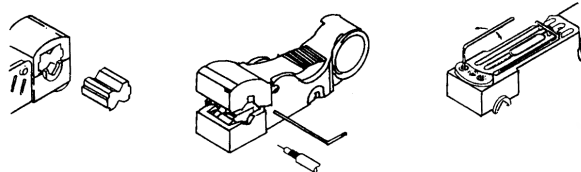

AWZ312B 38,00



LEMILICE ALLE**LEMILICA ERSA MS 250/S ALLE-ER/MS250S**

ERSA MS 250/S sa kontrolom temperature i alternativnom konekcijom instalacije za dve različite lemilice predstavlja dobar izbor i ispunjava zahteve hobi elektroničara. Multi lemilica od 25 W savršeno odgovara za sve standardne zahteve lemljenja. Vrh lemilice je opremljen visoko otpornom konekcijom prema unapred postavljenom mogućnošću izjednačenja šupljina. Držač za lemilice se može pričvrstiti za levu ili desnu stranu kontrolnog uređaja.

Tehnički podaci:

Izvor napajanja: 230 V ~, 50-60 Hz
Sekundarni napon: 12 V ~
Nominalna vrednost: max 32 W
Temperaturni opseg: neprekidno 120°C ... 460°C
Indikator: crvena LED
Kabl: 2m PVC sa konektorom

ERSA multi lemilica 25 W:

Napon: 12 V ~
Snaga: 25 W

ERSA mini lemilica 6 W:

Napon: 12 V
Snaga: 6 W

Sastav kompleta:

MS 253: Kontrolni uređaj
920BDH040: Multi lemilica 25 W sa vrhom 172 BD
010BDH040: Multi lemilica 25 W sa vrhom 012 BD
67100J: Držač lemilica

Cena: 225,00



Rezervni vrhovi :
012BD, A72BD, 172KD



LEMILICE ALLE**LEMILICA ERSA ANALOG 60 ALLE-ER/ANA60**

ANALOG 60 je standardni model lemilice sa elektronskom regulacijom temperature u ERSA novim serijama uređaja za lemljenje. Precizni ERSA RESISTRONIC kontrolni sistem iskorišćava pozitivne efekte PTC-a (Pozitivni Temperaturni Koeficijent) elementa zagrevanja. Visoki stepen zagrevanja od 190 W obezbeđuje momentalni izvor toplote. Osetljiva elektronika uređaja kontroliše radnu temperaturu merenjem otpornosti keramičkog elementa zagrevanja. Temperatura se može podešavati na lemilici na promenljivom opsegu između 150°C i 450°C. Laka za korišćenje lemilica se zagreva sa sobne temperature do 280°C za samo 60 sekundi.

Tehnički podaci:

Izvor napajanja:	230 V ~, 50-60 Hz
Sekundarni izvor napajanja:	24 V ~
Normalna vrednost:	60 W
Temperaturni opseg:	neprekidan 150°C ... 450°C
Indikator:	crvena LED
Kabl:	2m PVC sa konektorom

Osnovna lemilica 60 W:

Napon:	24 V ~
Opseg:	75 W / 280°C; 60 W / 350°C
Opseg zagrevanja:	190 W
Vreme zagrevanja:	60 s do 280°C
Tezina (bez kabla):	60g
Kabl:	1,5m ekstremno fleksibilan toplotno otporan

**Sastav kompleta:**

ANA 603:	Elektronska kontrolni uređaj
670 CDJ:	Osnovna lemilica 60 W sa vrhom 832 CD
A28:	Držač alata
67100J:	Rezervni toplotni deo za osnovnu lemilicu

Rezervni vrhovi :
SERIJA 832

Cena: 348,00



LEMILICE ALLE**LEMILICA ERSA SMT UNIT 60A ALLE-ER/SMT60A**

SMT UNIT 60A je uređaj za lemljenje i razlemljivanje sa elektronskom regulacijom temperature. Ima dve odvojeno kontrolisane alatke: ultra laku Mikro SMD lemlicu i promenljivu pincetu za razlemljivanje. Lemilica koristi ceo set dugotrajnih ERSADUR vrhova lemilica počevši od 0,2 mm. ERSA Mikro izvor vrhova lemilice omogućava da se podese odgovarajući stepen temperature u sekundama. Pinceta za odlemljivanje obuhvata sve MELF i mini MELF do SOIC, QFP i PLCC pakovanja. Veliki opseg pincete omogućava da uređaj koristite na svaku dostupnu SMD komponentu.

Tehnički podaci:

Izvor napajanja: 230 V ~, 50-60 Hz
Sekundarni napon: 24 V ~
Nominalna vrednost: 60 W
Temperaturni opseg: (mikro alati) postepeno 150°C ... 400°C
(pinceta 40) zavisno od vrhova
Indikator: crvena LED
Kabl: 2m PVC sa konektorom
Model: bezbedno izolovan, antistatički

**Mikro lemilica 25 W:**

Napon: 24 V ~
Opseg: 2 x 30 W / 280°C-2 x 20W / 350°C
Opseg zagrevanja: 60 W
Tezina (bez kabla) 25g
Kabl: 1.2 m fleksibilan termootporan

Pinceta 40:

Napon: 24 V ~
Opseg: 2 x 30 W / 280°C
Opseg zagrevanja: 130 W
Tezina (bez kabla) 75 g
Kabl: 1.2 m fleksibilan termootporan
Napon: 12 V
Snaga: 6 W

**Sastav kompleta:**

SMT 603:	Kontrolni uređaj	
270BDJ:	Mikro lemilica sa vrhom 212 BD	
430EDJ:	Pinceta 40 sa vrhom 422 ED	
A 29:	Držač za lemlicu	
A30:	Držač za pincetu 40	
43400:	Bezbedonosni set za tip 422	Rezervni vrhovi :
43500:	Bezbedonosni set za tip 212 i 422	212BD,212CD, 422ED

Cena:1220,00

18000 Niš, Jovana Ristića 7, P.O.Box 135, Tel: 018 / 520-455, 522-814, 522-965, fax: 522-660
http://www.MGelectronic.co.yu e-mail: office@MGelectronic.co.yu

LEMILICE ALLE**VAC 6500 ALLE-ER/VAC6500**

VAC 6500 je uređaj za razlemljivanje sa integrisanom vakuum pumpom. Visoki kapacitet zagrevanja zahvaljujući njegovom PTC (Pozitivni Temperaturni Koeficijent) elementu zagrevanja. Koristeći dokazanu ERSa RESISTRONIC kontrolu temperature, element zagrevanja funkcioniše kao temperaturna sonda u isto vreme. Može se podesiti željena temperatura na promenljivom opsegu. Integrisani prekidač na dršci aktivira vakuum pumpu. Transparentna lemilica sadrži u kompletu toplotno otpornu staklenu cev i držač. Za lako i brzo odstranjivanje lema (ostatka razlemljivanja) jednostavno se odviše drška lemilice.

Tehnički podaci:

Izvor napajanja:	230 V ~, 50 Hz
Opseg:	70 W / 350°C
Saga zagrevanja:	50 W / 350°C
Temperaturni opseg:	neprekidan 200°C ... 440°C
Tezina odlemljivača (bez kabla):	180 g
Kabl:	1,5 m PVC

Sastav kompleta:

VAC 653:	Vakuum uređaj
650 AE:	TC 65 alat za razlemljivanje
A28:	Vrh za razlemljivanje 657 AE
	Rezervni toplotni deo za osnovnu lemilicu
A13	Držač za 650 AE
3YN2018-00	Pravolinijski filter
657 AE	Rezervni vrh za razlemljivanje

Cena: 1225,00

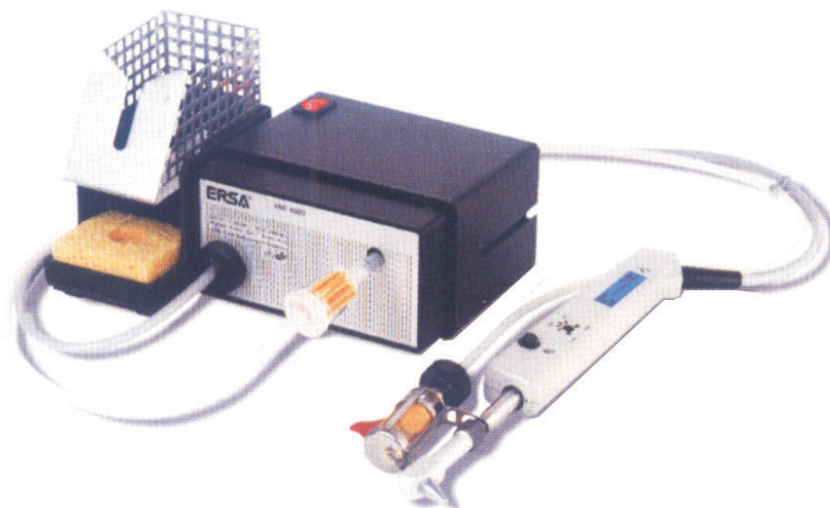

VRHOVI ZA LEMILICE ERSA

VRHOVI ZA LEMILICE ERSA ·········· ALLEV-ER

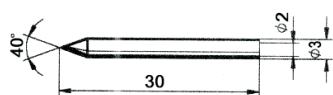

012BD....11,00

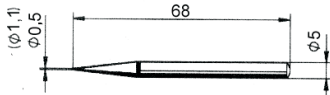

032BD....16,00

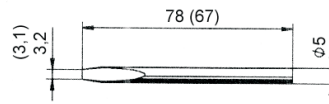

032KD....16,00

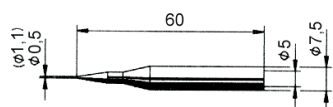

172BD....16,00

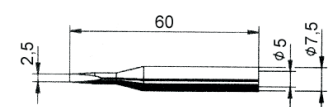

172KD....16,00

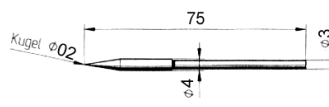

212BD....26,00

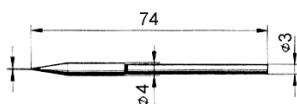

212CD....26,00

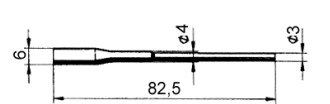

422ED....86,00

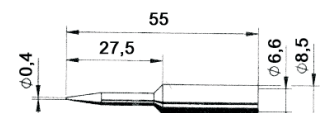

832UD....22,00

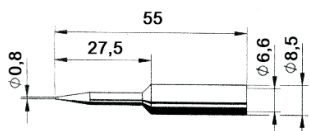

832SD....18,00

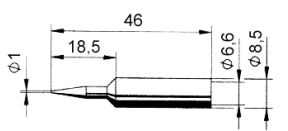

832BD....18,00

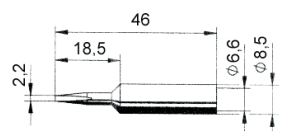

832CD....18,00

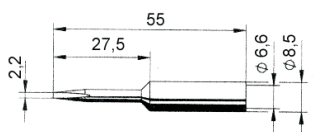

832KD....18,00

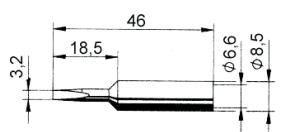

832ED....18,00

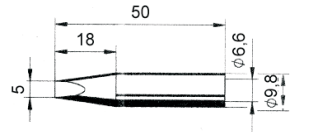

832VD....34,00

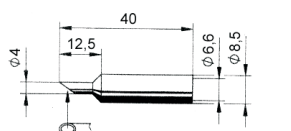

832PW....42,00

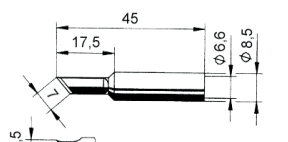

832AD....48,00

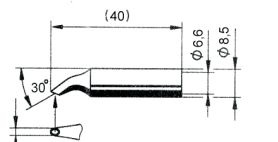

832HD....58,00

18000 Niš, Jovana Ristića 7, P.O.Box 135, Tel: 018 / 520-455, 522-814, 522-965, fax: 522-660
<http://www.MGelectronic.co.yu> e-mail: office@MGelectronic.co.yu

LEMILICE ALLE**LEMILICE PENSOL ALLE - PE****SL10****Tehnički podaci:**

Izvor napajanja: 220 V ~, 50 Hz
Regulacija temperature: potenciometrom
Snaga zagrevanja: 48 W
Temperaturni opseg: neprekidan 150°C ... 450°C
Napon zagrevanja: 24 V
Cena: 126,00

**SL20****Tehnički podaci:**

Izvor napajanja: 220 V ~, 50 Hz
Regulacija temperature: potenciometrom,
očitavanjem pomoću led diode
Snaga zagrevanja: 48 W / 350°C
Temperaturni opseg: neprekidan 150°C ... 420°C
Napon zagrevanja: 24 V
Cena: 185,00

**SL30****Tehnički podaci:**

Izvor napajanja: 220 V ~, 50 Hz
Regulacija temperature: potenciometrom,
sa digitalnim očitavanjem
Snaga zagrevanja: 48 W
Temperaturni opseg: neprekidan 160°C ... 480°C
Napon zagrevanja: 24 V
Cena: 225,00

LEMILICE ALLE**LEMILICA WELLER WTCP 51 ALLE-W/WTCP51**

WTCP 51 je standardni model lemilice sa elektronskom regulacijom temperature. Ova lemilica ima specijalni prekidač za kontrolisanje temperature vrha lemilice. Izborom određenog vrha lemilice bira se odgovarajuća temperatura. Brzo vreme zagrevanja (približno 30 sec.) i visoka rezerva (200% na 370°C) obezbeđuje veliku efikasnost pri lemljenju.

Tehnički podaci:

Izvor napajanja:	230 V ~, 50-60 Hz
Sekundarni izvor napajanja:	24 V ~
Normalna vrednost:	50 W
Temperaturni opseg:	neprekidan 150°C ... 450°C
Kabl:	2m PVC sa konektorom
Dimenzije:	166 x 115 x 101 mm

Osnovna lemilica 50 W:

Napon:	24 V ~
Opseg:	30 W / 280°C; 50 W / 350°C
Opseg zagrevanja:	50 W
Vreme zagrevanja:	30 s do 280°C
Tezina (bez kabla):	60g
Kabl:	1,5m ekstremno fleksibilan toplotno otporan

Weller®**Sastav kompleta:**

P 50:	Elektronska kontrolni uredjaj
TCP S:	Osnovna lemilica 50 W sa vrhom
KH 20:	Držač lemilice

**Rezervni vrhovi :
SERIJA PT**

Cena: 358,00



18000 Niš, Jovana Ristića 7, P.O.Box 135, Tel: 018 / 520-455, 522-814, 522-965, fax: 522-660
<http://www.MGelectronic.co.yu> e-mail: office@MGelectronic.co.yu

LEMILICE ALLE
LEMILICA WELLER WS 51 ALLE-WWS51

WS 51 je profesionalni model lemilice sa elektronskom - analognom regulacijom temperature. Podešavanje temperature od 150°C - 450°C reguliše se pomoću rotacionog potencijometra. Specijalno je dizajnirana za lemljenje temperaturno osetljivih elektronskih komponenata (C-MOS integrisana kola i FET tranzistori). Brzo vreme zagrevanja (približno 30 sec.) i visoka rezerva (200% na 370°C) obezbeđuje veliku efikasnost pri lemljenju.

Tehnički podaci:

Izvor napajanja:	230 V ~, 50-60 Hz
Sekundarni izvor napajanja:	24 V ~
Normalna vrednost:	50 W
Temperaturni opseg:	neprekidan 150°C ... 450°C
Indikator:	zeleni LED
Kabl:	2m PVC sa konektorom
Dimenzije:	166 x 115 x 101 mm

Osnovna lemilica 50 W:

Napon:	24 V ~
Opseg:	30 W / 280°C; 50 W / 350°C
Opseg zagrevanja:	50 W
Vreme zagrevanja:	30 s do 280°C
Tezina (bez kabla):	60g
Kabl:	1,5m ekstremno fleksibilan toplotno otporan

Weller®**Sastav kompleta:**

PU 51:	Elektronski kontrolni uređaj
LR 21:	Osnovna lemilica 50 W sa vrhom
KH 20:	Držač lemilice

Rezervni vrhovi :
SERIJA ET

Cena: 458,00



LEMILICE ALLE

VRHOVI ZA LEMILICE WELLER ALLEV-WEL

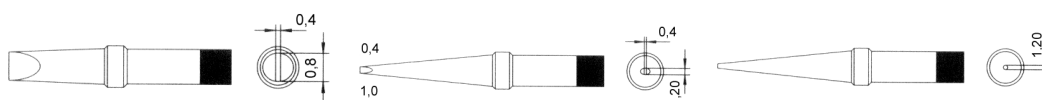

PTH....14,00

PTK....14,00

PTO....16,00

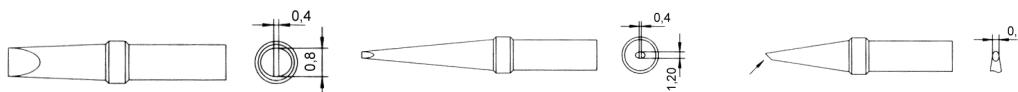

ETH....14,00

ETK....14,00

ETO....17,00

LEMILICA ZA SMD CT- 850 ALLE-CT/850

CT-850 je lemilica koja se specijalno koristi za lemljenje i razlemljivnje SMD komponenti. Širok opseg regulisanja temperature i protoka vazduha omogućava lemljenje QFP-a, SOP-a i PLCC-aPored ovoga CT-850 poseduje i automatsko hlađenje koje štiti elemente od zagrevanja. Isti vrh se moze koristiti i za lemljenje i za razlemljivanje, zbog bolje efikasnosti sistema.

Tehnički podaci:

Izvor napajanja: 230 V ~, 50-60 Hz
 Sekundarni izvor napajanja: 24 V ~
 Snaga: 20 W
 Kapacitet: max. 23l/min
 Dimenzije: 187x135x245mm

Pištalj za razlemljivanje:

Napon: 24 V ~
 Snaga: 250 W
 Temperatura vazduha: 100°C - 420°C
 Duzina: 196mm



Cena: 650,00

18000 Niš, Jovana Ristića 7, P.O.Box 135, Tel: 018 / 520-455, 522-814, 522-965, fax: 522-660
<http://www.MGelectronic.co.yu> e-mail: office@MGelectronic.co.yu

LEMILICE. ALLE



PIS LEMILICA, PIŠTOLJ 28,00
 220 V, 100 W



MLS48 SA REGULACIJOM TEMPERATURE 68,00
 220 V, 50 W 200 - 450°C



NICD NICD LEMILICA 72,00
 200 lema po 20 sec. 400°C



GAS PLINSKA LEMILICA 36,00

ALAT

AL

LEMILICE ALLE

LEMILICE - ŠTAP ALLES

30/12	30 W 12 V	15,00
30	30 W 220V AC	15,00
60	60 W 220 V AC	22,00
80	80 W 220 V AC	26,00



ERSA



ER/30S	30 W 220 V AC	68,00
---------------	---------------	-------



REZERVNI VRHOVI



V - S/30	za lemlicu 30 W,	2,00
V - S/60	za lemlicu 60 W,	2,50
V - S/80	za lemlicu 80 W	3,00

REZERVNI GREJAČI



G-S/1230	30 W, 220 V	5,00
G-S/30	30 W, 12V	5,00
G-S/60	60 W, 220 V	6,00
G-S/80	80 W, 220 V	7,00

STALAK ZA ŠTAP LEMILICE



ALLEST	9,00
---------------	------

ALAT

AL

VAKUUM PUMPE ALVP

01 9,00



02 12,00



03 16,00



04 26,00



REZERVNI VRHOVI ALVPRV

ZA TIP 01 i 02

ZA TIP 03 i 04



01 1,50

02 3,00

MINI BUŠILICE. ALBU

01 DC12-18V 40W, 12000 ob./min 28,00



02 DC12-18V 35W, 15000ob./min 26,00



MK KOMPLET, BUŠILICA 01 I ISPRAVLJAČ 56,00

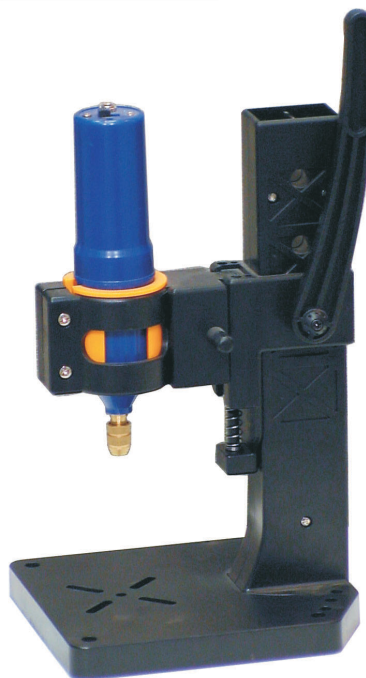

ST STALAK ZA BUŠILICU 02 58,00

BURGIJE ALBUR

- 0,32,50
- 0,42,20
- 0,52,00
- 0,81,70
- 1,01,50
- 1,21,60
- 1,51,70
- 2,01,80
- 2,51,80
- 3,01,90



ALAT**AL****PIŠTOLJI ALPI****PIŠTOLJ ZA KABLOVSKÉ VEZICE ALPISK**

Cena: 26,00

Napomena: Vezice za zatezanje kablova nalaze se u poglavlju kablovi

PIŠTOLJ ZA LEPLJENJE ALPISL

Cena: 22,00

MUNICIJA ZA PIŠTOLJ ZA LEPLJENJE**ALPISLM** Pakovanje 5 komada 2,50**TURPIJE ALTU**

M	MANJE	100mm	28,00
V	VEĆE	200mm	26,00



ALAT

AL

STEGE ALST

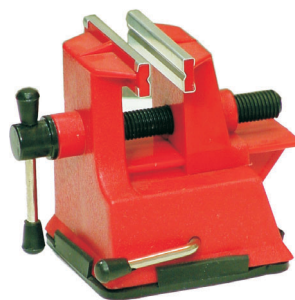
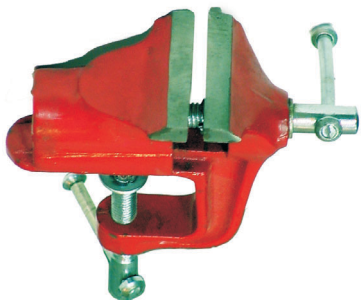

M METALNA 28,00

P PLASTIČNA 15,00

DRZAČI ŠTAMPANE PLOČICE ALDR



SP DRZAČ ŠTAMPANE PLOČICE 14,00

SPL DRZAČ ŠTAMPANE PLOČICE SA LUPOM 16,00



LUPA SA STALKOM, MANJA Ø 75
ALLUS75 . . .22,00



LUPA SA STALKOM, VEĆA Ø 110
ALLUS110 . . .26,00



RUČNA LUPA SA SIJALICOM
ALLURS . . .12,00



STONA LUPA VEĆA Ø 110 (FLUO CEV 22 W)
ALLUSV . . .158,00



NAGLAVNA LUPA SA SIJALICAMA
ALLUNA . . .28,00



STONA LUPA, MANJA Ø 100 (E 27/40 W)
ALLUSM . . .58,00

ALAT

AL

TELESKOP OGLEDALA ALTO

20

20 mm (150 mm)

Cena: 14,00



38

38 mm (125-560 mm)

Cena: 16,00



55

55 mm (125-560 mm)

Cena: 24,00

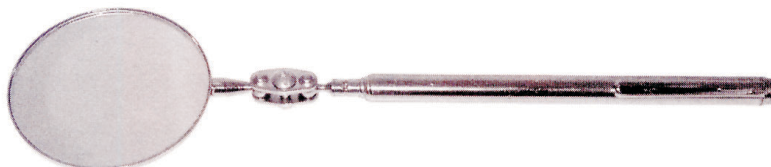

TESTERICA ALTEST

Komplet sa 10 rezervnih listova

Cena: 12,00

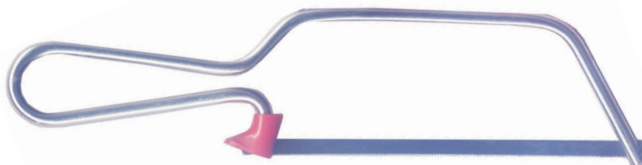

ŠTIMERI ALSTIM

Plastične štimeri za podešavanje trimera i kalemova kod TV, HI-FI, CB, AM i FM radio uređaja.

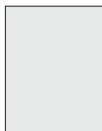

Cena: 9,00

ALAT

AL

- PRIBOR** **ALPR**
SKALPELI **ALPRSK**
PLASTIČNI **ALPRSKP**



01 MANJI 1,00

02 VEĆI 2,00

METALNI **ALPRSKM**



03..... 15,00

04..... 15,00

NOZIĆI ZA SKALPELE **ALPRSKN**

ZA TIP 03

ZA TIP 04

1011 špicasti

1024 okrugli



1015 okrugli

1025 ugaoni



Cena: 1,50

Cena: 1,50

ALAT

AL

PRIBOR **ALPR**
FLOMASTERI **ALPRFL**

VODOOTPORNI PERMANENT FLOMASTERI CRNE BOJE ZA ISPISIVANJE NA PLASTICI, STAKLU, METALU I OSTALIM MATERIJALIMA.

0,3 3,80



0,4 6,00



1,0 6,00



1,5 7,50

