

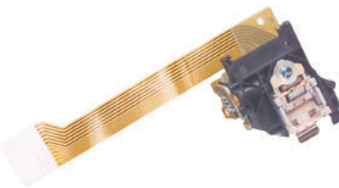



DELOVI ZA AUDIO UREDJAJE



Au



CD LASERSKE JEDINICE AUCDL

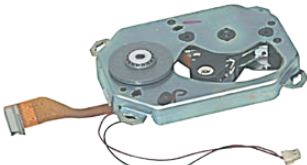

<p>CDM12.1HEAD GRUNDIG/MARANTZ/PHILIPS SCHNEIDER/TEHNICS</p>  <p>CDM12.1HEAD 48,00</p>	<p>CDM12.4 PHILIPS CDI P & CDI REC</p>  <p>CDM12.4 78,00</p>	<p>KSS151A AIWA/AKAI/DENON SONY</p>  <p>884806401 198,00</p>
---	---	---



<p>KSS210B AIWA/DAEWU/GOLDSTAR/SABA SANYO/SCHNEIDER/SONY</p>  <p>KSS210A KSS210B 46,00</p>	<p>KSS212B SONY</p>  <p>KSS212A KSS212B 48,00</p>	<p>KSS213A SONY</p>  <p>KSS213A KSS213B KSS213C KSS213D 46,00</p>
--	---	---



<p>CDM9 PHILIPS</p>  <p>CDM9 78,00</p>	<p>KSS330A SONY</p>  <p>KSS330A 86,00</p>	<p>KSS331A SONY</p>  <p>KSS331A 92,00</p>
---	--	--

18000 Niš, Jovana Ristića 7, P.O.Box 135, Tel: 018 / 520-455, 522-814, 522-965, fax: 522-660
<http://www.MGelectronic.co.yu> e-mail: office@MGelectronic.co.yu

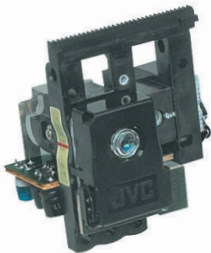
CD LASERSKE JEDINICE AUCDL

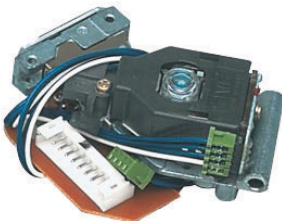
<p>KSS331E SONY</p> 	<p>KSS360A SONY</p> 	<p>KSS410A SONY</p> 
<p>KSS331E 115,00</p>	<p>KSS360A 142,00</p>	<p>KSS410A 228,00</p>

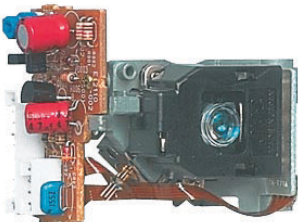
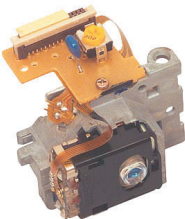

<p>OPTIMA2 JVC</p> 	<p>OPTIMA3 JVC</p> 	<p>OPTIMA4S JVC</p> 
<p>OPTIMA2 188,00</p>	<p>OPTIMA3 220,00</p>	<p>OPTIMA4S 220,00</p>

<p>OPTIMA5S JVC</p> 	<p>OPTIMA150S JVC</p> 	<p>PEA1030 PIONEER</p> 
<p>OPTIMA5S 82,00</p>	<p>OPTIMA150S 54,00</p>	<p>PEA1030 196,00</p>

CD LASERSKE JEDINICE AUCDL

<p>PEA1179 PIONEER</p> 	<p>PEA1291 PIONEER</p> 	<p>PWY1009 PIONEER</p> 
<p>PEA1179 158,00</p>	<p>PEA1291 178,00</p>	<p>PWY1009 222,00</p>

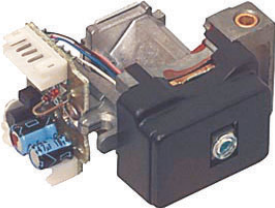
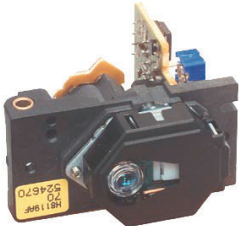
<p>PWY1010 PIONEER</p> 	<p>RAE0111Z PANASONIC,TEHNICS</p> 	<p>RAE0113Z PANASONIC,TEHNICS</p> 
<p>PWY1010 228,00</p>	<p>RAE0111Z 126,00</p>	<p>RAE0113Z 124,00</p>

<p>RCTRH8112 SHARP</p> 	<p>RCTRH8119 SHARP</p> 	<p>RCTRH8124 SHARP</p> 
<p>RCTRH8112 66,00</p>	<p>RCTRH8119 188,00</p>	<p>RCTRH8124 176,00</p>

18000 Niš, Jovana Ristića 7, P.O.Box 135, Tel: 018 / 520-455, 522-814, 522-965, fax: 522-660
<http://www.MGelectronic.co.yu> e-mail: office@MGelectronic.co.yu

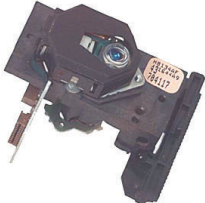
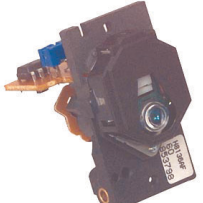
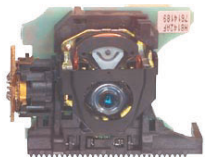

CD LASERSKE JEDINICE AUCDL

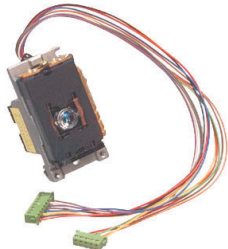
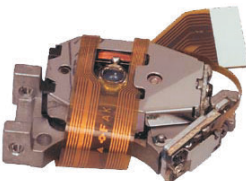
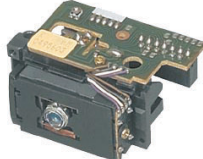

<p>RCTRH8134 SHARP</p>  <p>RCTRH8134 156,00</p>	<p>RCTRH8136 SHARP</p>  <p>RCTRH8136 182,00</p>	<p>RCTRH8142 SHARP</p>  <p>RCTRH8142 182,00</p>
--	--	--

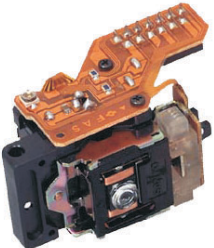

<p>RCTRH8147 SHARP</p>  <p>RCTRH8147 72,00</p>	<p>RCTRH8151 SHARP</p>  <p>RCTRH8151 52,00</p>	<p>SF91-8/5 SANYO,SUPERTECH</p>  <p>SF91-8/5 54,00</p>
---	---	---

<p>SF91-8/5W SANYO,SUPERTECH</p>  <p>SF91-8/5W 48,00</p>	<p>SF92.5 SANYO620.218.3220</p>  <p>SF92.5 48,00</p>	<p>SFP1 AKAI,FISHER,PIONEER SANYO,SCHNEIDER</p>  <p>SFP1 98,00</p>
---	---	---

CD LASERSKE JEDINICE AUCDL

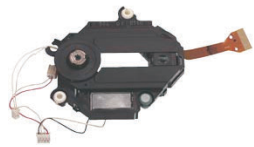
<p>SFP100 SANYO SA VELIKIM KONEKTOROM</p>  <p>SFP100 58,00</p>	<p>SFP100S SANYO SA MALIM KONEKTOROM</p>  <p>SFP100S 58,00</p>	<p>SOAD70A PANASONIC</p>  <p>SOAD70A 228,00</p>
---	---	--

<p>SOALP1200KM3 PANASONIC</p>  <p>SOALP1200MK3 286,00</p>	<p>SOALP320KMZ PANASONIC</p>  <p>SOALP320KMZ 94,00</p>	<p>SODD110Z PANASONIC</p>  <p>SODD110Z 128,00</p>
--	---	--

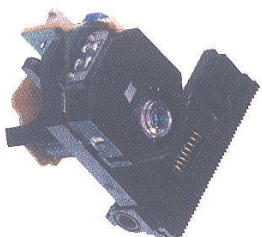
<p>SOH90T4N AKAI,SAMSUNG</p>  <p>SOH90T4N 68,00</p>	<p>SOHA1 SAMSUNG</p>  <p>SOHA1 48,00</p>	<p>SOAD40A3 KENWOOD</p>  <p>SOAD40A3 112,00</p>
--	---	--

CD LASERSKE JEDINICE AUCDL

AIWA					
CAB500	KSS210A	CXN450G	KSS210A	DXZ7000M	KSS210A
CADW500	KSS210A	CXN540	KSS210A	DXZ82	KSS210A
CDESE177	KSS213B	CXN550G	KSS210A	DXZ830	KSS210A
CNX400	KSS210A	CXN560G	KSS210A	DXZ850	KSS210A
CSDEX1	KSM210BAJ	CXN990	KSS210A	DXZ87	KSS210A
CSDEX1	KSM210BAJ	CXN999	KSS210A	DXZ9100M	KSS210A
CSDEX1	KSS210B	CXNAP1	KSM2101ABM	DXZ92	KSS210A
CSDEX1	KSS210B	CXNAP1	KSS210A	DXZ93	KSS210A
CSDEX210	KSM210BAJ	CXNV20	KSS210A	DXZ950M	KSS210A
CSDEX210	KSS210B	CXNV70	KSL2101ABM	FDN606	KSS210A
CSDEX310	KSM210BAJ	CXNV70	KSM2101ABM	FDN636	KSS210A
CSDEX310	KSS210B	CXNV70	KSS210A	FDN707	KSS210A
CVDZ93W	KSS210A	CXNV8	KSS210A	FDN909	KSS210A
CX810Z	KSS210A	CXSL50	KSS210B	FDN939	KSS210A
CXAP1	KSS210B	CXSL70	KSS210A	LCX01	KSS210A
CXL60	KSS210A	CXSN340	KSS210A	LCX50	KSS210A
CXL66G	KSS210A	CXSN345	KSS210A	LCX60	KSS210A
CXL7	KSS210B	CXZ1000M	KSM2101ABM	LCX66G	KSS210A
CXL80	KSS210A	CXZ1000M	KSS210A	LCX7	KSS210B
CXL8G	KSS210B	CXZ58	KSS210B	LCX70M	KSS210A
CXL9	KSM2101BAJ	CXZ650	KSS210A	LCX80	KSS210A
CXLC50P	KSS210B	CXZ670	KSS210A	LCX8G	KSS210B
CXLF7	KSM210BAJ	CXZ720	KSS210A	LCX9	KSS210B
CXLF7	KSS210B	CXZ750M	KSS210A	LCXAP1	KSS210B
CXN270	KSL2101ABM	CXZ870	KSS210A	LCXF7	KSS210B
CXN270	KSM2101ABM	CXZ900M	KSS210A	M7400	KSS210A
CXN270	KSS210A	DX1500	884805601	M75	KSS210A
CXN2700	KSL2101ABM	DX370MG	KSS210A	NSX220	KSS210A
CXN2700	KSM2101ABM	DX990A	KSS152A	NSX270	KSS210A
CXN2700	KSS210A	DXD1A	KSS152A	NSX320	KSS210A
CXN3100	KSS210A	DXM100	KSS210A	NSX330	KSS210A
CXN320	KSS210A	DXM350M	KSS210A	NSX332	KSS210A
CXN3200	KSS210A	DXM351M	KSS210A	NSX340	KSS210A
CXN3300	KSS210A	DXM352M	KSS210A	NSX345	KSS210A
CXN340	KSS210A	DXM740	KSS210B	NSX360	KSS210A
CXN360	KSS210A	DXM75	KSS210B	NSX400	KSS210A
CXN3900	KSM2101ABM	DXM76	KSS210B	NSX430	KSS210A
CXN3900	KSS210A	DXM77	KSS210B	NSX450G	KSS210A
CXN400	KSS210A	DXM80	KSS210B	NSX550G	KSS210A
CXN4000	KSM2101ABM	DXN3	KSS210A	NSX990	KSS210A
CXN4000	KSS210A	DXN370MG	KSS210A	NSX992	KSS210A
CXN430	KSS210A	DXN7	KSS210A	NSX999	KSS210A
CXN4500G	KSM2101ABM	DXN9	KSS210A	NSXA92	KSS210A
CXN4500G	KSS210A	DXNR3	KSS210A	NSXD603	KSS210A

CD LASERSKE JEDINICE AUCDL

AIWA		XSZ890M	KSS210A	MX105	KSS210A
NSXD606	KSS210A	XSZ900M	KSS210A	MX520	KSS210A
NSXD636	KSS210A	Z650	KSS210A	MX550	KSS210A
NSXD707	KSS213A	Z670	KSS210A	MX570	KSS210A
NSXD909	KSS210A	ZD3000	KSS210A	MX650	KSS210A
NSXD939	KSS210A	ZD3100	KSS210A	MX670	KSS210A
NSXV20	KSS210A	ZD5000M	KSS210A	MX750	KSS210A
NSXV8	KSS210A	ZD7000M	KSS210A	MX950	KSS210A
RXN5K	KSS210A			RX590	KSS210A
SXFN450	KSS210A	AKAI		RX593	KSS210A
SXFN4500	KSS210A	ACM350L	SFP1	RX595	KSS210A
SXFN550	KSS210A	ACM350S	SFP1	RX597	KSS210A
SXN400	KSS210A	ACM370	SFP1	RX890	KSS210A
SXN520	KSS210A	ACM370L	SFP1	RX897	KSS210A
XC002	KSS210B	ACM373	SFP1	TC590	KSS210A
XC004	KSS210B	ACM395	SOH90T4N	TC890	KSS210A
XC005	KSS210B	ACM48L	SFP1		
XC007	KSS210A	ACM58	SFP1	AMSTRAD	
XC300	KSS210A	ACM68	SFP1	MCD100	KSS210B
XC500	KSS210A	ACM77	KSS210A	MICRO1000	KSS210B
XC750	KSS210A	ACMX100	SFP1		
XC777	KSS210B	ACMX100S	SFP1	B & O	
XC900	KSS210A	ACMX105	KSS210A	CP2790	KSS210A
XC950	KSS210A	ACMX115L	KSS210A	CP2890G	KSS210A
XC990	KSS210A	ACMX115S	KSS210A		
XCN992	KSS210A	ACMX370	KSS210A	CEC	
XG320	KSS210A	ACMX470	KSS210A	540CD	SFP1
XG360	KSS210A	ACMX92	SFP1	640CD	SFP1
XG400	KSS210A	ACMX92L	SFP1		
XG990	KSS210A	ACMX92S	SFP1	CROWN	
XP31	KSS210A	AJ305CD/E/V	KSS210B	CDG100	KSS331A
XP33	KSS210A	CD25	KSS210A		
XP55	KSS210A	CD26	KSS210A	DAEWOO	
XP6	KSS331A	CD27	KSS210A	ACD4300	KSS210B
XP7	KSS331A	CD32	KSS210A	ACD7300	KSS210A
XP80G	KSS220A	CD36	KSS210A	ACD7310	KSS210A
XSZ1000M	KSS210A	CD37	KSS210A	AMI230	KSS210A
XSZ720M	KSS210A	CD52	KSS210A	AMI310	KSS210A
XSZ750M	KSS210A	CD55	KSS210A	AMI3100	KSS210A
XSZ760M	KSS210A	CD57	KSS210A	AMI960	OPTIM5S
XSZ850M	KSS210A	CD650	KSS210A		
XSZ860M	KSS210A	CD670	KSS210A	DENON	
XSZ870	KSS210A	CDM770	KSS210A	DCD1420	KSS210A
XSZ880M	KSS210A	CDM959	KSS210A	DCD1500II	KSS151A

CD LASERSKE JEDINICE AUCDL

DCD1520	KSS151A	DACZ1	SFP1	CCD680	CDM121
DCD3520	KSS151A	DCSG30	SFP1	CD1	CDM121
DCD520	KSS210A			CD1000	CDM121
DCD610	KSS210A	GOLDSTAR		CD101	KSS210A
DCD620	KSS210A	CD320A	KSS210B	CD102	CDM121
DCD660	KSS210A	CD320A/LL	KSS210B	CD11	CDM121
DCD680	KSS210A	CD330A	KSS210A	CD12	CDM121
DCD810	KSS210A	CD340L	KSS210B	CD120	CDM121
DCD820	KSS210A	CD390A/L	KSS210A	CD2	CDM121
DCD860	KSS210A	CD541A/L	KSS210A	CD210	CDM121
DCD910	KSS210A	CD546A	KSS210A	CD3	CDM121
UCDMF10	KSS210A	CD560A/L	KSS210A	CD436	CDM121
		CD630A	KSS210B	CD437	CDM121
DUAL		CD630S/LL	KSS210B	CD6	CDM121
2500	KSS210A	CD640M	KSS210B	CD904	KSS210A
3701	KSS210A	CD940M	KSS210A	CD905	OPTIMA5S
CD1004-1	KSS210A	CD952A	KSS210A	CDC14	CDM121
CD1006-1	KSS210A	CD952AJ	KSS210A	CDC477	CDM121
CD100RS	KSS210A	CD952LJ	KSS210A	CLCD6	CDM121
CD1015-1	KSS210A	CD952SJ	KSS210A	KRCD100	KSS210B
CD1015RC	KSS210A	FFH100A/L	KSS210B	M1	KSS210A
CD1016-1	KSS210A	FFH101KL	KSS210A	M15	CDM121
XC900	KSS210A	FFH101AL	KSS210A	M16	CDM121
CD1040	OPTIMA2	FFH212A/L	KSS210B	M2	CDM121
CD1045	KSS210A	FFH212E	KSS210B	M20LWM1	KSS210A
CD1050RC	KSS210A	FFH272L	KSS210A	M20LWM3A	KSS210A
CD1065	KSS210A	FFH303L	KSS210A	M25	CDM121
CD1070RC	KSS210A	FFH333L	KSS210A	M26	CDM121
CD115RC	KSS210A	FFH373L	KSS210A	M30CD	CDM121
CD135RC	KSS210A	FFH49A/L	KSS210A	M40CDC	CDM121
CD3000	KSS210A	FJ606	KSS210A	M5	KSS210A
CD3700	KSS210A	FMH17RA/RS	KSS210A	M6	CDM121
CD3701	KSS210A	FMH49A/L	KSS210A	MC10	KSS210A
MIDI3701	KSS210A	FR606L	KSS210A	NEWORLEAN-	KSS210A
MINI2700	KSS210A	FR606L	KSS210A	SCD	KSS210A
MINI2500	KSS210A	RDM321A	KSS210B	PA2	CDM121
ML25	CDM121	YGP50	KSS210B	PA3	CDM121
				R102	CDM121
FISHER		GOODMANS		R120	CDM121
AD530	SFP1	SYS2700	KSS210A	RCD400	CDM121
AD9030	SFP1			RR1900CD	KSS210B
AD935	SFP1	GRUNDIG		RR3100CD	KSS210B
ADM82	SFP1	CCD300	KSS210A	RR4000CD	KSS210B
ADZ1	SFP1	CCD670	SFP1	RR610CD	KSS210B

CD LASERSKE JEDINICE. AUCDL

RR700CD	KSS210B	CAE21	OPTIMA6S	OPTIMA2	OPTIMA2
SYSTEM120	CDM121	CAE21LKB	OPTIMA4	OPTIMA3	OPTIMA3
SYSTEM220	CDM121	CAE48	OPTIMA6S	OPTIMA4S	OPTIMA4S
UMS1	CDM121	CAE48BK	OPTIMA6S	OPTIMA5S	OPTIMA5S
UMS2	CDM121	CAMX30BK	OPTIMA5S	OPTIMA6S	OPTIMA6S
		CAMX33BK	OPTIMA5S	PCQS11	OPTIMA6S
		CAMX52	OPTIMA6S	PCV2	OPTIMA3
HARMAN KAR		CAMXC5BK	OPTIMA5S	PCX103	OPTIMA150S
EN300	KSS210A	CAMXG7	OPTIMA6S	PCX105	OPTIMA6S
EN500	KSS210A	CAMXG9	OPTIMA6S	PCX105	OPTIMA150S
300	KSS210A	CAMXS2	OPTIMA6S	PCX106	OPTIMA150S
500	KSS210A	CAMXS2BK	OPTIMA6S	PCX110	OPTIMA6S
HD7225	KSS210A	CAMXS2K	OPTIMA6S	PCX110	OPTIMA150S
HD7325	KSS210A	CAMXS3	OPTIMA6S	PCX130	OPTIMA6S
HD7400	KSS210A	CAMXS3BK	OPTIMA6S	PCX130	OPTIMA150S
HD7500	KSS210A	CAMXS4	OPTIMA6S	PCX500	KSS210B
TL8500	KSS210A	CAMXS6	OPTIMA6S	PCX55	OPTIMA6S
DH7425	KSS210A	CAS20	OPTIMA6S	PCX55	OPTIMA150S
HD7625	KSS210A	CAS200	OPTIMA6S	PCX75	OPTIMA150S
HD7725	KSS210A	CAS20BK	OPTIMA6S	PCX95	OPTIMA6S
		CAS30	OPTIMA6S	PCX95	OPTIMA150S
HITACHI		CAS300	OPTIMA6S	PCXC10BK	OPTIMA150S
AXC10	KSS210B	CAS30BK	OPTIMA6S	PCXC30	OPTIMA150S
XC900	KSS210B	CAS50	OPTIMA6S	RCB1	OPTIMA5S
CFD455L	KSS210B	CAS500	OPTIMA6S	RCQ50	OPTIMA6S
CFD60L	KSS210A	CAS60	OPTIMA6S	RCQ50	OPTIMA150S
CXW300E	KSS210A	CAS600	OPTIMA6S	RCQS10	OPTIMA150S
DAE650	KSS210A	CAS60RBK	OPTIMA6S	RCQS11	OPTIMA6S
FX10	KSS210A	F3000R	OPTIMA150S	RCQS11	OPTIMA150S
FX9E	KSS210A	HX5	OPTIMA150S	RCQS12	OPTIMA150S
		MX1L	OPTIMA5S	RCQS22	OPTIMA150S
JVC		MX50	OPTIMA5S	RCQW33	OPTIMA150S
AXMX66BK	OPTIMA5S	MXD2T	OPTIMA150S	RCQW35	OPTIMA150S
CAD3S	OPTIMA150S	MXD301T	OPTIMA150S	RCQW55	OPTIMA150S
CAD4T	OPTIMA150S	MXD351TR	OPTIMA150S	RCX230	OPTIMA6S
CAD5T	OPTIMA150S	MXD401T	OPTIMA150S	RCX230	OPTIMA150S
CAD601T	OPTIMA150S	MXD451T	OPTIMA150S	RCX240	OPTIMA150S
CAD631T	OPTIMA150S	MXD451TR	OPTIMA150S	RCX310	KSS210A
CAD651TR	OPTIMA150S	MXD551TR	OPTIMA150S	RCX320	OPTIMA6S
CAD701T	OPTIMA150S	MXS2	OPTIMA6S	RCX320BK	OPTIMA150S
CAD75TR	OPTIMA150S	MXS20	OPTIMA6S	RCX510	KSS210B
CAD7T	OPTIMA150S	MXS3	OPTIMA6S	RCX520	OPTIMA6S
CAD851TR	OPTIMA150S	MXS30	OPTIMA6S	RCX520	OPTIMA150S
CAD85TR	OPTIMA150S	MXS60	OPTIMA6S	RCX620	OPTIMA6S
CAD8T	OPTIMA150S				

CD LASERSKE JEDINICE AUCDL

RCX620	OPTIMA150S	XLF154BK	OPTIMA150S	XLV131	OPTIMA5S
RCX720	OPTIMA6S	XLF215	OPTIMA6S	XLV131BK	OPTIMA5S
RCX720	OPTIMA150S	XLF216	OPTIMA6S	XLV141	OPTIMA5S
RCX740	OPTIMA150S	XLF254BK	OPTIMA150S	XLV142	OPTIMA5S
RCXC1	OPTIMA150S	XLF5THBK	OPTIMA150S	XLV151	OPTIMA5S
RCXC3BK	OPTIMA150S	XLM303	OPTIMA5S	XLV151TN	OPTIMA5S
TMXC5	OPTIMA6S	XLM306	OPTIMA5S	XLV152	OPTIMA5S
UX1000GR	OPTIMA150S	XLM307	OPTIMA5S	XLV152BK	OPTIMA5S
UX1500RGR	OPTIMA150S	XLM309	OPTIMA5S	XLV162	OPTIMA6S
UX2000RGD	OPTIMA150S	XLM309BK	OPTIMA5S	XLV163TN	OPTIMA6S
UXA4	OPTIMA6S	XLM403	OPTIMA5S	XLV164	OPTIMA6S
UXA5	OPTIMA5S	XLM403BK	OPTIMA5S	XLV164BK	OPTIMA6S
UXA50BK	OPTIMA150S	XLM404	OPTIMA5S	XLV164BK	OPTIMA5S
UXA55	OPTIMA6S	XLM405	OPTIMA5S	XLV174	OPTIMA6S
UXA55R	OPTIMA150S	XLM406	OPTIMA5S	XLV211	OPTIMA4S
UXA6	OPTIMA5S	XLM407	OPTIMA5S	XLV211BK	OPTIMA4S
UXA60RBS	OPTIMA150S	XLM408	OPTIMA5S	XLV22	OPTIMA2
UXC30	OPTIMA150S	XLM409	OPTIMA5S	XLV220	OPTIMA2
UXC40R	OPTIMA150S	XLM504	OPTIMA5S	XLV221	OPTIMA5S
UXC7	OPTIMA6S	XLM504BK	OPTIMA5S	XLV221BK	OPTIMA5S
UXD88	OPTIMA150S	XLM505	OPTIMA5S	XLV222	OPTIMA5S
UXD99R	OPTIMA150S	XLM505TN	OPTIMA5S	XLV222BK	OPTIMA4S
UXT1	OPTIMA6S	XLM508	OPTIMA5S	XLV225BK	OPTIMA2
UXT100	OPTIMA150S	XLM509	OPTIMA5S	XLV230BK	OPTIMA150S
UXT20	OPTIMA150S	XLM705	OPTIMA5S	XLV231	OPTIMA5S
UXT200R	OPTIMA150S	XLM705TN	OPTIMA5S	XLV235	OPTIMA5S
XL900	OPTIMA3	XLMC100	OPTIMA6S	XLV241	OPTIMA5S
XLE3	OPTIMA2	XLMC100C/M	OPTIMA6S	XLV241TN	OPTIMA5S
XLE300	OPTIMA4S	XLMCM1	OPTIMA150S	XLV242	OPTIMA5S
XLE300BK	OPTIMA4S	XLME77	OPTIMA5S	XLV242BK	OPTIMA5S
XLE31	OPTIMA4S	XLME90	OPTIMA5S	XLV250BK	OPTIMA2
XLE31BK	OPTIMA4S	XLME91	OPTIMA4S	XLV251	OPTIMA5S
XLE34	OPTIMA5S	XLME91BK	OPTIMA4S	XLV251TN	OPTIMA5S
XLE3BK	OPTIMA2	XLME93	OPTIMA5S	XLV252	OPTIMA5S
XLE45	OPTIMA5S	XLMG7	OPTIMA6S	XLV252BK	OPTIMA5S
XLE5	OPTIMA3	XLMG800PTN	OPTIMA5S	XLV263TN	OPTIMA6S
XLE51	OPTIMA4S	XLMG9	OPTIMA6S	XLV264	OPTIMA6S
XLE53	OPTIMA4S	XLMX70	OPTIMA5S	XLV264BK	OPTIMA6S
XLE56	OPTIMA5S	XLMXG7	OPTIMA6S	XLV274	OPTIMA6S
XLE57	OPTIMA5S	XLMXG9	OPTIMA6S	XLV274BK	OPTIMA6S
XLE77	OPTIMA5S	XLSD1GD	OPTIMA150S	XLV311	OPTIMA4S
XLE900BK	OPTIMA3	XLV101	OPTIMA4S	XLV311BK	OPTIMA4S
XLF115	OPTIMA6S	XLV101BK	OPTIMA4S	XLV330	OPTIMA2
XLF116	OPTIMA6S	XLV120BK	OPTIMA4S	XLV330BK	OPTIMA2

CD LASERSKE JEDINICE AUCDL

XLV330BK	OPTIMA2	KENWOOD	M77A	KSS240A
XLV333	OPTIMA4S	DP1030	M850	KSS210A
XLV333BK	OPTIMA4S	DP1050	PD3030	KSS210A
XLV341	OPTIMA5S	DP1060	RCTRH8136	KSS240A
XLV342	OPTIMA5S	D1510A	PD3060	KSS210A
XLV440	OPTIMA2	DP2010	PDM991	KSS210A
XLV440BK	OPTIMA2	DP2030	RDX25	KSS210A
XLV450	OPTIMA2	DP2050	RXD25L	KSS210A
XLV550	OPTIMA2	DP2060	RXDC2	KSS210A
XLV550BK	OPTIMA2	DP28	RXDC2/6	KSS210A
XLZ1010	OPTIMA4S	DP3010	RXDC3	KSS210A
XLZ1010TN	OPTIMA4S	DP3030	RXDC3L	KSS210A
XLZ1050	OPTIMA5S	DP3050	UD202	KSS210A
XLZ1050TN	OPTIMA5S	DP3060	UD302	KSS210A
XLZ331	OPTIMA5S	DP4030	UD502	KSS210A
XLZ335	OPTIMA5S	DP491	UD70	KSS240A
XLZ411	OPTIMA4S	DP501	UD701	KSS240A
XLZ411BK	OPTIMA4S	DP5010	UD90	KSS240A
XLZ431	OPTIMA5S	DP5040	XA3L	KSS240A
XLZ441	OPTIMA5S	DP5060	XE5	KSS240A
XLZ442	OPTIMA5S	DP520	NAD	
XLZ444	OPTIMA4S	DP5600	502	KSS210A
XLZ444BK	OPTIMA5S	DP7030	510	CDM121
XLZ451	OPTIMA5S	DP7040	512	KSS210A
XLZ452	OPTIMA5S	DP7050	515	CDM121
XLZ454	OPTIMA6S	DP722	523	KSS210A
XLZ463TN	OPTIMA6S	DP730	5420	KSS210A
XLZ464BK	OPTIMA6S	DP76	5425	KSS210A
XLZ551	OPTIMA5S	DP920		
XLZ551TN	OPTIMA5S	DP930	NORMENDE	
XLZ552	OPTIMA5S	DP950	CP3002	KSS210A
XLZ552BK	OPTIMA5S	DPB5	CP3501	KSS210A
XLZ555	OPTIMA4S	DPB6		
XLZ555BK	OPTIMA4S	DPB9	ONKYO	
XLZ574	OPTIMA6S	DPM450	C711	KSS240A
XLZ611	OPTIMA4S	DPM650	DX1800	KSS210A
XLZ611BK	OPTIMA4S	DPM6630	DX6620	KSS210A
XLZ674	OPTIMA6S	DPM7730	DX6650	KSS210A
XTMXG7	OPTIMA6S	DPM850	DX6920	KSS210A
XTMXG9	OPTIMA6S	DPM991	DX6930	KSS210A
XTMXS6	OPTIMA6S	M225	DX7011	KSS210A
XTS60	OPTIMA6S	M25	DXC110	KSS240A
XXLM309	OPTIMA5S	M450	DXC210	KSS210A
XXLM508	OPTIMA5S	M650	TCW21	KSS210A

CD LASERSKE JEDINICE AUCDL

PANASONIC		CDC925	CDM121	N450M	PEA1179
RAE0130Z	RAE0130Z	CDC926	CDM121	N50	PEA1179
RX-DS25	RAE0113	CDC935	CDM121	N70	PEA1179
RXDS05	RAE0113Z	CDM12-1	CDM121	N90M	PEA1030
RXDT30	RAE0113Z	CDM12-1/05	CDM121	N90T	PEA1030
RXDT610	SODD110Z	FS911	CDM121	PCDP530M	PEA1179
RXDT670	SODD110Z	FSR931	CDM121	PD101	PEA1030
RXDT680	SODD110	FW11	OPTIMA6S	PD102	PEA1179
SODD110	SODD110Z	FW14	CDM121	PD103	PEA1179
SACH350	RAE0111Z	FW15	CDM121	PD201	PEA1030
SAHD52	SODD110Z	FW17	CDM121	PD202	PEA1179
SCHD52	SODD110Z	FW20	CDM121	PD203	PEA1179
SLCH505	RAE0111Z	FW26/25	CDM121	PD2560T	PWY1010
SODD110Z	SODD110	FW30	CDM121	PD31	PEA1030
SCHD52	SODD110Z	FW31	CDM121	PD310	PEA1030
		FW330	CDM121	PD32	PEA1030
		FW330/25	CDM121	PD4050	PWY1010
PHILCO		FW34	CDM121	PD4050S	PWY1010
DL7000	KSS210A	FW36	CDM121	PD40S	PWY1010
DL7500	KSS210A	FW36/25	CDM121	PD4100	PWY1010
PDA5000	KSS210A	FW360	CDM121	PD4300	PWY1010
PDA6000	KSS210A	FW360/25	CDM121	PD4350	PWY1010
PRAMP10	KSS210A	FW37	CDM121	PD4350	PWY1009
PRDT400	KSS210A	FW40	CDM121	PD4500	PEA1030
		FW40/25	CDM121	PD4500S	PEA1030
PHILIPS		FW41	CDM121	PD4550	PEA1030
70CD730	CDM121	FW46	CDM121	PD4550S	PEA1030
AS440	CDM121	FW56	CDM121	PD4700	PEA1030
ASA445	CDM121	FW630	CDM121	PD5050	PWY1010
AS540	CDM121	FW650	CDM121	PD5100	PWY1010
AZ8006	KSS210B	FW66	CDM121	PD52	PEA1030
CD163	CDM121	FW68	CDM121	PD5300	PWY1010
CD165	CDM121	FW68/22B	CDM121	PD54	PEA1179
CD410	CDM121	FW70/25	CDM121	PD5500	PEA1030
CD710	CDM121	FW76	CDM121	PD5500S	PEA1030
CD720	CDM121	FW80/25	CDM121	PD5700	PEA1030
CD733	CDM121			PD6050	PWY1010
CD740	CDM121	PIONEER		PD6050S	PWY1010
CD750	CDM121	DP4100	PWY1010	PD6100	PWY1010
CD910	CDM121	DP5100	PWY1010	PD6100S	PWY1010
CD911	CDM121	DPM503	PEA1179	PD6300	PWY1010
CD920	CDM121	FZ93L	PEA1030	PD65	PEA1030
CD921	CDM121	N100	PEA1179	PD6500	PEA1030
CDC751	CDM121	N32	PEA1030	PD6500S	PEA1030
CDC916	CDM121				

CD LASERSKE JEDINICE AUCDL

PD6700	PEA1030	PDM601	PEA1179	PDX930M	PWY1010
PD7050	PWY1010	PDM601	PEA1179	PDX940M	PWY1009
PD7050S	PWY1010	PDM602	PEA1179	PDX950M	PEA1009
PD7300	PEA1030	PDM603	PEA1179	PDZ560T	PWY1009
PD7500	PEA1030	PDM610	PWY1009	PDZ560T	PWY1010
PD7700	PEA1030	PDM630	PEA1030	PDZ570T	PEA1030
PD7700S	PEA1030	PDM650	PEA1030	PDZ71	PWY1010
PD8700	PEA1030	PDM700	PWY1009	PDZ72T	PWY1009
PD8700S	PEA1030	PDM701	PEA1179	PDZ72T	PWY1010
PD9700	PEA1030	PDM710	PWY1009	PDZ73T	PWY1009
PDC3	PEA1179	PDM730	PWY1009	PDZ74T	PEA1030
PDC5	PEA1179	PDM750	PEA1030	PDZ81M	PWY1010
PDCP420	PEA1030	PDM901	PEA1030	PDZ82M	PWY1009
PDCP520	PEA1030	PDP710T	PEA1030	PDZ83M	PWY1009
PDCP520M	PEA1030	PDP720T	PEA1030	PDZ84M	PEA1030
PDCP520T	PEA1030	PDP730T	PEA1179	PDZ960M	PWY1009
PDCP630T	PEA1179	PDP910M	PEA1030	PDZ970M	PEA1030
PDJ400T	PEA1030	PDP920M	PEA1030	PEA1030	PEA1030
PDJ410	PEA1030	PDS501	PEA1030	PWY1009	PWY1009
PDJ500T	PEA1030	PDS502	PEA1179	PWY1010	PWY1010
PDJ510	PEA1179	PDS503	PEA1179	PXA1349	PEA1030
PDJ800M	PEA1030	PDS601	PEA1030	RXP500	PEA1030
PDJ800MT	PEA1030	PDS602	PEA1179	S125CDT	PEA1030
PDM40	PWY1010	PDS603	PEA1179	S135CDT	PEA1030
PDM400	PWY1009	PDS701	PEA1030	S303CDM	PEA1030
PDM40S	PWY1010	PDS701G	PEA1030	S303CDT	PEA1030
PDM410	PWY1009	PDS702	PEA1179	S505DM	PEA1030
PDM430	PEA1030	PDS702G	PEA1179	S505DT	PEA1030
PDM435	PEA1030	PDS703	PEA1179	S707DM	PEA1030
PDM435S	PEA1030	PDS802	PEA1179	S707DT	PEA1030
PDM450	PEA1030	PDS901	PEA1030	S909DM	PEA1030
PDM453	PEA1030	PDSET82M	PWY1009	S909DT	PEA1030
PDM455	PEA1030	PDT303	PWY1009	XCP410M	PEA1030
PDM50	PDY1010	PDT310	PEA1030	XCP410T	PEA1030
PDM500	PWY1009	PDT403	PWY1009	XDZ53T	PWY1009
PDM501	PEA1179	PDT503	PWY1009	XDZ54T	PEA1030
PDM502	PEA1179	PDT510	PEA1030	XDZ55T	PEA1030
PDM51	PEA1030	PDTM2	PEA1179	XDZ62M	PWY1009
PDM510	PWY1009	PDX530	PWY1010	XDZ63M	PWY1009
PDM530	PEA1030	PDX540	PWY1010	XDZ64M	PEA1030
PDM550	PEA1030	PDX550	PWY1010	XDZ65M	PEA1030
PDM551	PEA1179	PDX66	PWY1009	XDZ84T	PEA1030
PDM552	PEA1179	PDX77M	PWY1009	XDZ92T	PWY1009
PDM600	PWY1009	PDX77M	PWY1010	XRP240C	SFP1

CD LASERSKE JEDINICE AUCDL

XRP310	PEA1030	CS2870CD	KSS210A	CDP41	SFP100
XRP320	PEA1030	CS2880CD	KSS210B	CDP450	SFP100
XRP320	PEA1030	CS3270CD	KSS210A	CDP45A	SF92
XRP330	PEA1179	CS3570	KSS210A	CDP50A	SF92
XRP340	PEA1179	CS3572CD	KSS210A	CDP550	SF92
XRP340M	PEA1179	DAB800T	KSS210A	CDP55A	SF92
XRP3500M	PEA1179	DAD800TV2	KSS210A	CDP60	SF92
XRP440	PEA1179	MCS1503CD	SFP1	CDP650	SF92
XRP4500M	PEA1179	RCD700	KSS210B	CDP67	SF92
XRP500	PEA1030			CP488	SFP1
XRP5500M	PEA1179	SAMSUNG		CP489	SFP1
XRP640	PEA1179	CD1200	KSS210A	CP59	SFP1
XRP640M	PEA1179	CD1310	KSS210A	CP8300	SFP1
XRP740	PEA1179	MAX330	KSS210A	CP8500	SF90
XRP740M	PEA1179	MAX335	KSS210A	CP868	SFP1
XTZ62T	PWY1009	MAX345	SOHA1	CP890	SFP1
		MS3900	KSS210A	CPM2403	SFP1
		MYCD2N	KSS210A	CPM303	KSS210A
ROADSTAR		PCD730	KSS210A	DCD10	SF90
CD900N	SFP1	RCD1550	KSS210A	DCD10	SFP1
PCD9000	KSS331A	RCD1600	KSS210A	DCD11U	SFP1
PCD950	KSS220A	RCD830	KSS210A	DCD27U	SFP100
RCR3507L	KSS210B	RCD980	KSS210A	DCD30	SFP1
RCR3509	KSS210B	SCM6000	KSS210A	DCD30AT	SFP1
		SCM6500	KSS210A	DCD8	SFP1
SABA		SCM6900	KSS210A	DCD8U	SFP1
CD1015V2	KSS210A	SCM8550	KSS210A	DCDJ1	SFP1
CD1016V2	KSS210A	SCM8900	KSS210A	DCMS1	SFP1
CD1017	KSS210A	SCM9100	KSS210A	DCS33	SFP1
CD1017TC	KSS210A			DCX1000MD	KSS210A
CD1018	KSS210A	SANSUI		DCX1003	KSS210A
CD1035TC	KSS210A	CDV100	KSS210A	DCX550	SFP1
CD2015-3RC	KSS210A	CDX105	KSS210A	DCX900MD	KSS210A
CD2030TC	KSS210A	CDX301	KSS210A	DCX993	SFP1
CD2030TCRC	KSS210A	CDX311	KSS210A	DCX994	SFP1
CD3561	KSS210A	CDX317	KSS210A	MCD450K	SFP1
CDP11	OPTIMA2	CDX501	KSS210A	MCDMS40L	SFP1
CDP3	KSS220A	CDX510	KSS210A	MCDMS50F	SFP1
CDZD15-3RC	KSS210A			MCDMS50L	SFP1
CS1550CD	KSS210A	SANYO		MCDMS660L	SFP1
CS1570CD	KSS210A	6142271303	SFP1	MCDS660L	SFP1
CS2250CD	KSS210B	6142279069	SF90	MCDS670L	SFP100
CS2770CD	KSS210A	CDP150	SFP100	MCDZ1L	SFP1
CS2780CD	KSS210B	CDP350	SFP100	MCDZ2L	SFP1
CS2850CD	KSS210B				

CD LASERSKE JEDINICE AUCDL

MCDZ31L	KSS210B	CD555	RCTRH8134	CMRS400CHD	RCTRH8136
MCDZ37L	SFP100	CDC2400	RCTRH8147	CMS150	RCTRH8136
MCDZ3F	SFP1	CDC2400H/G	RCTRH8147	CMS150CDH	RCTRH8136
MCDZ3L	SFP1	CDC250H	RCTRH8147	CMS95CD	RCTRH8112
MCDZ41L	KSS210B	CDC260H	RCTRH8147	CMSN50	RCTRH8136
MCDZ61L	KSS210B	CDC265	RCTRH8151	CMSR160	RCTRH8147
MCDZ71	KSS210B	CDC3	RCTRH8112	CMSR400	RCTRH8136
MCDZ77	SFP100	CDC4450	RCTRH8147	CMSR400CDH	RCTRH8136
MCDZ8F	SFP100	CDC5300H	RCTRH8142	CP150	RCTRH8136
MCDZ93F	SFP100	CDC550H	RCTRH8147	CPC250	RCTRH8147
MCH900L	KSS210B	CDC560H	RCTRH8147	CPC550	RCTRH8147
MCHS970L	KSS210B	CDC770	RCTRH8147	CPR400	RCTRH8136
SF91	SFP1	CDC770H	RCTRH8147	CPS360	RCTRH8136
SFP1	SFP1	CDJX3	RCTRH8124	CPS370	RCTRH8136
		CDL700	RCTRH8112	CPXL12	RCTRH8147
		CDL800	RCTRH8112	DX150	RCTRH8112
		CDQ5H	RCTRH8151	DX160	RCTRH8136
SCHNEIDER		CDS160	RCTRH8134	DX160EM	RCTRH8112
160	KSS210A	CDS200H	RCTRH8147	DX160HM	RCTRH8112
200RC	KSS210A	CDS3460	RCTRH8147	DX3400	RCTRH8136
MCS300	SFP1	CDS350	RCTRH8136	DX450	RCTRH8112
MIAMI	SFP1	CDS360	RCTRH8136	DX450	RCTRH8136
MIDI2295	CDM121	CDS360E	RCTRH8136	DX450EM	RCTRH8112
MINIMS285	KSS210A	CDS360H	RCTRH8136	DX450HM	RCTRH8112
ML10	KSS210B	CDS370	RCTRH8136	DX460HM	RCTRH8112
ML101	OPTIMA6	CDS400	RCTRH8136	DX461	RCTRH8112
ML12	OPTIMA6	CDS450	RCTRH8136	DX650H	RCTRH8112
ML25	CDM121	CDS450E	RCTRH8136	DX660	RCTRH8112
MP125	KSS210A	CDS450H	RCTRH8136	DX670HM	RCTRH8112
MS225	CDM121	CDS600	RCTRH8119	DX999	RCTRH8112
MS285	KSS210A	CDS610	RCTRH8134	DXA3	RCTRH8112
MSC286	KSS210A	CDS6470H/E	RCTRH8147	DXN45	RCTRH8112
QUEENS160	KSS210A	CDU1	RCTRH8136	DXR554H	RCTRH8112
QUEENS200RC	KSS210A	CDX10	RCTRH8112	DXR555H	RCTRH8112
SPP90	KSS210A	CDX100	RCTRH8136	DXR75	RCTRH8112
SPP903	KSS210A	CDX12	RCTRH8112	DXR750H	RCTRH8112
SPP903	KSS210A	CDX15	RCTRH8112	DXR77	RCTRH8112
SHARP		CDX16	RCTRH8112	DXR770	RCTRH8112
CD111	RCTRH8112	CDX17	RCTRH8112	DXR820	RCTRH8112
CD301	RCTRH8112	CDX20	RCTRH8112	DXR840	RCTRH8112
CD302	RCTRH8136	CDX200	RCTRH8113	DXZ100	RCTRH8112
CD304	RCTRH8112	CDX200AV	RCTRH8113	DXZ100H	RCTRH8112
CD310	RCTRH8136	CDX9	RCTRH8136	DXZ1500	RCTRH8112
CD320	RCTRH8136	CLK650	RCTRH8112	H8136AF	RCTRH8136
CD555	RCTRH8134				

CD LASERSKE JEDINICE AUCDL

H8147AF	RCTRH8147	CD2030C	KSS210A	CDP227ESD	KSS151A
QT30CD	RCTRH8112	CD3030R	KSS210A	CDP228ESD	KSS151A
QT33CD	RCTRH8112	P333R	KSS210A	CDP24	KSS210A
QT350CD	RCTRH8112			CDP250	KSS210A
QT37CD	RCTRH8112	SIEMENS		CDP255	KSS210A
QT38CD	RCTRH8112	RA306R4	KSS331A	CDP27	KSS210A
QT500CD	RCTRH8124	RD118G4	KSS210B	CDP270	KSS210A
QT50CD	RCTRH8124	RD118G4II	KSS210B	CDP301M	KSS210A
QT600CD	RCTRH8124	RD120R4	KSS210B	CDP305M	KSS210A
QT60CD	RCTRH8124	RD120R4II	KSS210B	CDP305ESD	KSS210A
QT80	RCTRH8124	RD125G4	SFP1	CDP308ESD	KSS210A
QTC20	RCTRH8112	RD127G6	KSS210B	CDP31	KSS210A
QTC23	RCTRH8112	RS175R4	KSS210B	CDP310	KSS210A
QTC24	RCTRH8134	RS232R4	SFP1	CDP32	KSS210A
QTC245	RCTRH8134	RS238R6-11	KSS210B	CDP338ESD	KSS210A
QTC25	RCTRH8124	RS247G4	KSS210B	CDP34	KSS210A
QTC27	RCTRH8134	RS247G4IIA	KSS210B	CDP350	KSS210A
QTC277H	RCTRH8151	RS247G4IIB	KSS210B	CDP350II	KSS210A
RCTRH812	RCTRH8112	RS247G6	KSS210B	CDP36	KSS210A
RCTRH8124	RCTRH8124	RS247G6IIA	KSS210B	CDP37	KSS210A
RCTRH8136	RCTRH8136	RS247G6IIB	KSS210B	CDP370	KSS210A
RCTRH8142	RCTRH8142	RS248R4	KSS210B	CDP38	KSS210A
RCTRH8147	RCTRH8147	RS248R4IIA	KSS210B	CDP390	KSS210A
SC3700	RCTRH8136	RS248R4IIB	KSS210B	CDP407	KSS210A
SC7700CDH	RCTRH8136	RS248R6	KSS210B	CDP450	KSS210A
SC7700HMK2	RCTRH8136	RS248R6IIA	KSS210B	CDP470	KSS210A
SC77CD	RCTRH8112	RS24R6-11B	KSS210B	CDP48	KSS210A
SC8000	RCTRH8119	RS282R6	KSS210B	CDP505ESD	KSS151A
SC8800	RCTRH8119	RS282R6II	KSS210B	CDP507ESD	KSS151A
SC99CD	RCTRH8112	RS283R6	KSS210B	CDP508ESD	KSS151A
SGA1	RCTRH8112	RS283R6II	KSS210B	CDP550	KSS210A
SGW1CD	RCTRH8112			CDP570	KSS210A
SGW2CD	RCTRH8112	SONY		CDP608ESD	KSS151A
WQCD220	RCTRH8134	884851201	KSS331A	CDP670	KSS210A
WQCD54	RCTRH8147	C125	KSS331A	CDP68	KSS210A
WQCD55	RCTRH8147	CDP110	KSS210A	CDP690	KSS210A
WQCH400H	RCTRH8151	CDP111	KSS210A	CDP710	KSS210A
WQCH800H	RCTRH8147	CDP190	KSS210A	CDP750	KSS210A
XL12H	RCTRH8147	CDP205ESD	KSS210A	CDP770	KSS210A
XL88HT	RCTRH8147	CDP207ESD	KSS210A	CDP910	KSS151A
		CDP208ESD	KSS210A	CDP950	KSS210A
SHERWOOD		CDP21	KSS210A	CDP970	KSS210A
CD1060	KSS210A	CDP22	KSS210A	CDPC100	KSS210A
CD1062R	KSS210A	CDP222ESD	KSS151A	CDPC15ESD	KSS210A

CD LASERSKE JEDINICE AUCDL

CDPC20	KSS210A	CDPV925E	KSS210A	CFD58	KSS210B
CDPC30	KSS210A	CDPXE	KSS213B	CFD58L	KSS210B
CDPC301M	KSS210A	CDPXE800	KSS213B	CFD58S	KSS210B
CDPC305M	KSS210A	CDPXE900	KSS213B	CFD60	KSS210B
CDPC44	KSS210A	CDX5070	KSS410A	CFD60L	KSS210B
CDPC50	KSS210A	CDX5072	KSS410A	CFD60S	KSS210B
CDPC500	KSS210A	CDX51	KSS410A	CFD64	KSS210B
CDPC500A	KSS210A	CDX51RF	KSS410A	CFD66	KSS210B
CDPC500M	KSS210A	CDX630E	KSS210A	CFD66L	KSS210B
CDPC50M	KSS210A	CDZ1	KSS210A	CFD66S	KSS210B
CDPC57	KSS210A	CFD10	KSS210B	CFD68	KSS210B
CDPC5F	KSS210A	CFD100	KSS210B	CFD7	RCTRH8147
CDPC5M	KSS210A	CFD100L	KSS210B	CFD750	KSS210B
CDPC5S	KSS210A	CFD100S	KSS210B	CFD750L	KSS210B
CDPC70	KSS210A	CFD105L	KSS210B	CFD750S	KSS210B
CDPC700	KSS210A	CFD10L	KSS210B	CFD755L	KSS210B
CDPC7ESD	KSS210A	CFD11	KSS210B	CFD755L	KSS210B
CDPC800	KSS210A	CFD11L	KSS210B	CFD755L	KSS210B
CDPC8ESD	KSS210A	CFD120	KSS210B	CFD755S	KSS210B
CDPC8ESD	KSS210A	CFD120L	KSS210B	CFD757L	KSS360A
CDPC900	KSS210A	CFD125L	KSS210B	CFD758L	KSS360A
CDPC9ESD	KSS210A	CFD20L	KSS210B	CFD760	KSS210B
CDPM20	KSS210A	CFD300	KSS210B	CFD760L	KSS210B
CDPM201	KSS210A	CFD300L	KSS210B	CFD760S	KSS210B
CDPM20S	KSS210A	CFD330	KSS210B	CFD765	KSS210B
CDPM25	KSS210A	CFD440	KSS210B	CFD765L	KSS210B
CDPM26	KSS210A	CFD440L	KSS210B	CFD765S	KSS210B
CDPM27	KSS210A	CFD444	KSS210B	CFD767L	KSS360A
CDPM29	KSS210A	CFD444L	KSS210B	CFD768L	KSS360A
CDPM30	KSS210A	CFD444S	KSS210B	CFD770	KSS210B
CDPM301	KSS210A	CFD454	KSS210B	CFD770L	KSS210B
CDPM35	KSS210A	CFD454S	KSS210B	CFD770S	KSS210B
CDPM37	KSS210A	CFD455	KSS210B	CFD775	KSS210B
CDPM45	KSS210A	CFD455L	KSS210B	CFD775L	KSS210B
CDPM47	KSS210A	CFD455S	KSS210B	CFD775S	KSS210B
CDPM50	KSS210A	CFD460	KSS210B	CFD8	RCRTH8147
CDPM55	KSS210A	CFD50	KSS210B	CFDD440S	KSS210B
CDPM75	KSS210A	CFD500	KSS210B	CFDD73	KSS210B
CDPM77	KSS210A	CFD50L	KSS210B	CFDD735	KSS210B
CDPM78	KSS210A	CFD50S	KSS210B	CFDD75	KSS210B
CDPM79	KSS210A	CFD55	KSS210B	CFDDW83	KSS210B
CDPM95	KSS210A	CFD55L	KSS210B	CFDD83MK2	KSS210B
CDPM97	KSS210A	CFD55MK2S	KSS210B	CFDW100	KSS210B
CDPR1A	KSS151A	CFD55S	KSS210B	CFDW100S	KSS210B

CD LASERSKE JEDINICE AUCDL

D113	KSS331A	SLP777	SOAD70A	COMPACT3400	SFP1
D13	KSS331A	SLP999	SOAD70A	COMPACT3500	SFP1
D130	KSS331A	SLPA10	SOAD70A	CS1000	KSS210B
D131	KSS331A	SLPA45	SOAD70A	CS1500	CDM121
D132	KSS331A	SLPC20	SOAD70A	DP1000	KSS210A
D133	KSS331A	SLPD867E-K	RAE0113Z	DP1000CD	KSS210A
		SLPG360	CDM121	HP207	KSS210A
		SLPG370A	CDM121	HP850	KSS210A
TEAC		SLPG460	CDM121	HP850CD	KSS210A
CDP3100	KSS210A	SLPG470A	CDM121	HP851CD	KSS210A
CDP4100	KSS210A	SLPJ20	SOALP1200KM3	HS685	KSS210A
		SLPJ22	SOALP1200KM3	HS695	KSS210A
TEHNICS		SLPJ25	SOAD70A	HS810	KSS210A
E10	SODD110	SLPJ26	SOAD70A	HS810V2	KSS210A
RXD24	KSS210A	SLPJ44	SOALP1200KM3	HS820	KSS210A
RXDT55	SODD110Z	SLPJ45	SOAD70A	HS830	KSS210A
RXDT680	SODD110Z	SLPS670A	CDM121	HS830CD	KSS210A
SAHD52	SODD110Z	SLPS700	SOAD70A	HS831CD	KSS210A
SCCH7	SODD110Z	SLPS770A	CDM121	HS850CD	KSS210A
SCHD52	SODD110Z	SLPS840	SOAD70A	HS885	KSS210A
SCHD62	SODD110Z	SLPS900	SOAD70A	HS895	KSS210A
SLCH550	RAE0111Z	SYSTEME10	SODD110Z	HS975	KSS210A
SLCH7	SODD110Z	SYSTEMSCCH7	SODD110Z	HS975V2	KSS210A
SLE10	SODD110Z	SYSTEMX510D	SODD110Z	HS980	OPTIMA2
SLJ7	SODD110Z	SYSTEMX900D	SODD110Z	RC881CD	KSS210B
SLP100	SOALP1200KM3	X510D	SODD110Z	RC890CD	KSS210A
SLP1000	SOALP320KMZ	X900D	SODD110Z	RC900CD	KSS210A
SLP110	SOALP1200KM3			RC900CD	SFP1
SLP111	SOALP1200KM3	TELEFUNKEN		STUDIO1	KSS210B
SLP117	SOALP1200KM3	2000CD	KSS210A		
SLP1200	SOALP1200KM3	2200CD	KSS210A	THOMSON	
SLP200	SOAD70A	2500CD	KSS210A	CDR400	KSS210B
SLP210	SOALP1200KM3	CD STUDIO1	KSS210A	RT8082	KSS210B
SLP220	SOALP320KMZ	CD	KSS210B		
SLP222	SOAD70A	CD1000	KSS210B	UNIVERSUM	
SLP230	SOAD70A	CD300	KSS210A	ART0176263	KSS210A
SLP250	SOAD70A	CD300V2	KSS210A	ART035027	KSS210A
SLP310	SOALP1200KM3	CD500	KSS210A	ART0657080	KSS210A
SLP320	SOALP320KMZ	CDSTUDIO 1	KSS210B	CD4315	KSS210A
SLP333	SOAD70A	COMPACT2000	KSS210A	VTC4630	KSS210A
SLP420	SOALP1200KM3	COMPACT2200	KSS210A		
SLP520	SOALP1200KM3	COMPACT2500	KSS210A	YAMAHA	
SLP555	SOAD70A	COMPACT3000	SOHOT3	CDC501	SFP1
SLP555	SOAD70A	COMPACT3200	SFP1	CDC555	SFP1
SLP720	SOALP1200KM3				

ROLERI ZA KASETOFONE AUROL

<p>1702 1,30</p>	<p>1703 1,50</p>	<p>1704 1,80</p>
<p>1711 1,50</p>	<p>1714 2,00</p>	<p>1715 1,30</p>
<p>1716 1,80</p>	<p>1718 1,30</p>	<p>1722 1,30</p>
<p>1725 1,30</p>	<p>1725 1,30</p>	<p>1727 1,30</p>
<p>1728 1,30</p>	<p>1736 1,30</p>	<p>1737 1,30</p>

18000 Niš, Jovana Ristića 7, P.O.Box 135, Tel: 018 / 520-455, 522-814, 522-965, fax: 522-660
<http://www.MGelectronic.co.yu> e-mail: office@MGelectronic.co.yu

AUDIO GLAVE ZA KASETOFONE AUG

Tip	Cena	Opis	DC otpornost (Ω)	Impedansa	Dimenzije sl.
M	4,00	mono standardna	200 Ω \pm 25%	1KHz 850 Ω	1
U	7,00	stereo za dek. ugaona	200 Ω \pm 25%	1KHz 850 Ω	1
P	6,00	Amir 999, stereo za dek. poluokrugla	200 Ω \pm 25%	1KHz 850 Ω	1
ST	4,00	JVC, NACIONAL, stereo standardna	220 Ω \pm 25%	1KHz 850 Ω	2
SONY	5,00	SONY, stereo plitka	220 Ω \pm 25%	1KHz 850 Ω	3
REV	11,00	Stereo autorevers	300 Ω \pm 25%	1KHz 900 Ω	3
BR	4,00	Glava za brisanje	5,5 Ω \pm 25%	50KHz 330 Ω	4

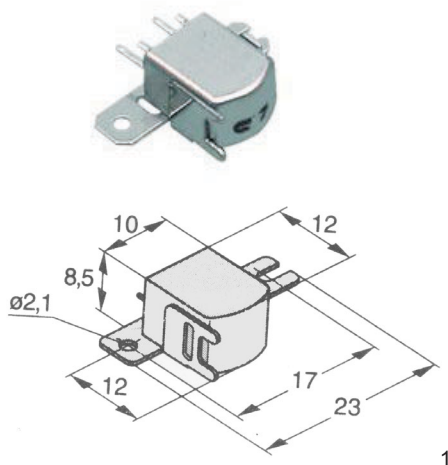

1

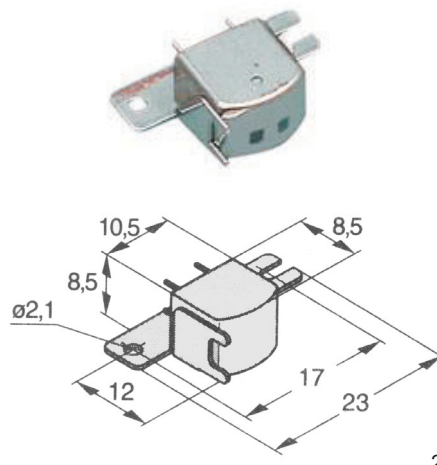

2

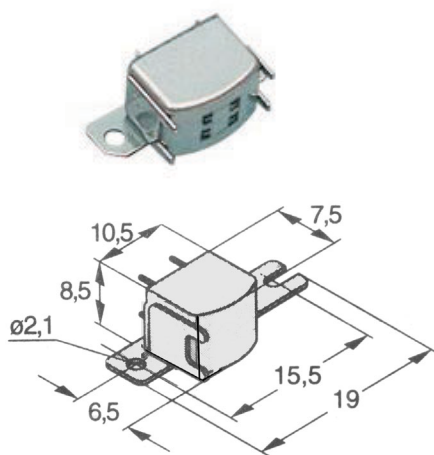

3

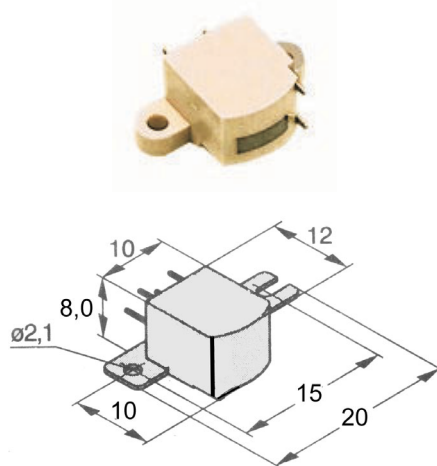

4

MOTORI ZA KASETOFONE AUMOT-K

Oznaka	Napon	Rotacija	Brzina (o/mn)
06L	6V	CCW levi	2400
06D	6V	CW desni	2400
09L	9V	CCW levi	2400
09D	9V	CW desni	2400
12L	12V	CCW levi	2400
12D	12V	CW desni	2400

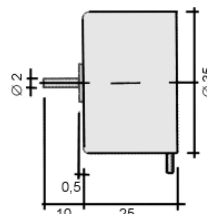

Cena: 8,00

MOTORI ZA KAS. DEKOVE AUMOT-D

Oznaka	Napon	Rotacija	Brzina (o/mn)
06D	6V	CW desni	2400
09L	9V	CW levi	2400
09D	9V	CW desni	2400
12L	12V	CCW levi	2400
12D	12V	CW desni	2400

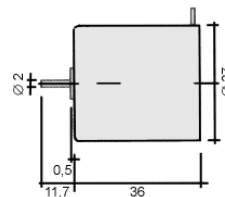

Cena: 12,00

MOTORI SA DVE BRZINE AUMOT-DV

Oznaka	Napon	Rotacija	Brzina (o/mn)
09	9V	CCW levi	2000/4000
12	12V	CCW levi	2000/4000
12-1	12V	CCW levi	1600/3200

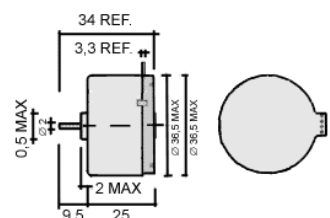

Cena: 11,00

MOTORI ZA CD-SPINDEL MOTORI. AUMOT-CD

Oznaka	Napon	Osovina (mm)
08	5,9V	8
14	5,9V	14
22	5,9V	22,5

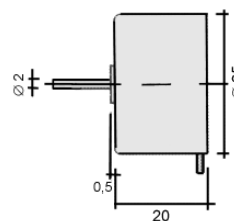

Cena: 18,00

Napomena: Motori za videorekordere obrađeni su u katalogu VIDEODELOVI

18000 Niš, Jovana Ristića 7, P.O.Box 135, Tel: 018 / 520-455, 522-814, 522-965, fax: 522-660
http://www.MGelectronic.co.yu e-mail: office@MGelectronic.co.yu

AUDIO IGLE ZA GRAMOFONE AUIG

ADC	AIWA	AUDIO TEHN.	AUDIO TEHN.	AUDIO TEHN.	BSR
 RL 3	 AN 60	 ATPN 1	 ATN 70	 ATN 3472P	 ST16
 RQ 4	 AN 70	 ATVM 8	 ATN 71	 ATN 3600	 ST20
 RK 8	AKAI	 ATS 10	 ATN 72	 ATN 3651E	CEC
 R 20X	 RS 33	 ATS 11	 ATN 91	 ATN 3711	 RS3
 RP 30	 RS 90	 ATS 12	 ATN 102P	AUE	 MC 6/BW2
 RSQ 30	 RS 100	 ATN 12XE	 ATN 102EP	 SA 111-01	 DMC 20
AIWA	AKG	ATN13 EAV	ATN 771	BSR	COLUMBIA
 AN 30	 X 8 S	 ATN 20	 ATN 3400	 TC 8RS	 DSN 38
 AN 50	 X 10 S	 ATN 51	 ATN 3401	 ST 12	 DSN 45

AUDIO IGLE ZA GRAMOFONE AUIG

COLUMBIA  DSN50	DUAL  DN 85	DUAL  DN 21 1	DUAL  DN 330	DUAL  DN 390E	EXEL  S55
 DSN 60	 DN 105	 DN 221	 DN 340	 DN 450	 S70SR
CONER  33	 DN 120	 DN 236	 DN 345	ELAC  D 155-17	 N700CR
 RCS	 DN 140S	 DN 239	 DN 350		HITACHI  DSST 12
 RCS	 DN 145 E	 DN 242	 DN 352	 DM 240	
DUAL  DN 4	 DN 155E	 DN 245	 DN 353	 D244 - 17	 DSST 15
 DN 8	 DN 165E	 DN 305	 DN 360	 DN 793	 DSST 30
 DN 55	 XDN 166E	 DN 320	 DN 362		 DSST 40
	 DN 201	 DN 325	 DN 380E		 DSST 101

18000 Niš, Jovana Ristića 7, P.O.Box 135, Tel: 018 / 520-455, 522-814, 522-965, fax: 522-660
<http://www.MGelectronic.co.yu> e-mail: office@MGelectronic.co.yu

AUDIO IGLE ZA GRAMOFONE AUIG



HITACHI  DSST 102	PANASONIC  EPS 14	PANASONIC.  EPS 207ED	ONKYO  DN 56ST	ORTOFON  D20 EII	PHILIPS  946 D 60
 DSST 103	 EPS 23CS	 EPS 270	ORTOFON  NADEL 5	PE  188SS	 946 D 65
LUXOR  65977 S	 EPS 24CS	NIVICO  DTZ 1S	 NADEL 10	 190SS	 946 D 66
MARANTZ  CT 551	 EPS 27 CS	 DT 36	 N 15	 192SS	 946 D 69
 CT 551	 EPS 30CS	 DT 37L	 N 15II	PHILIPS  946 S 46	 GP 215
MICRO  V - P 1	 EPS 33ES	 DT 41	 NF 15II	 946 S 46	 GP 214
	 EPS 41STSD	 DT 45	 NF 15XEII	 946 S 50	 946 D 74
	 EPS 202ED	 DT51	 NADEL 20	 946SS50	

AUDIO IGLE ZA GRAMOFONE AUIG

PICKERING	PIONEER	RONETTE	SANSUI	SANYO	SANYO
 D 1507AT	 PN K 65	 SC 109S	 SN 505	 ST 29D	 ST 102SD
 D 1507AC2	 PN 110	SANSUI	 SN 707	 ST 38 D	SHARP
 D 625	 PN 135	 SN 26	SANYO	 ST 41 D	 STY 101
PIEZO	 PN 150	 SN 28	 ST 05	 ST 44 D	 STY 104
 AN 308II	 PN 220	 SN 37	 STG 6	 ST 44J	 STY 112
 AN 121	 PN 250T	 SN 41	 ST 07 D	 ST 55D	 STY 113
PIONEER	 PN 290T	 SN 80	 ST 09D	 ST 66D	 STY 116
 PN 3MC	 PN 301	 SN 303	 STG 10	 ST 100SD	 STY 117
 PN 5MC		 SN 313	 ST 10J	 ST101SD	 STY 121

18000 Niš, Jovana Ristića 7, P.O.Box 135, Tel: 018 / 520-455, 522-814, 522-965, fax: 522-660
<http://www.MGelectronic.co.yu> e-mail: office@MGelectronic.co.yu

AUDIO IGLE ZA GRAMOFONE AUIG

<p>SHARP</p>  <p>STY 124</p>	<p>SHURE</p>  <p>VN 35 E</p>	<p>SHURE</p>  <p>N91 ED</p>	<p>SONY</p>  <p>ND 137G</p>	<p>SUPRAPHON</p>  <p>VM 2102</p>	<p>TETRAD</p>  <p>T 2MS</p>
 <p>STY 127</p>	 <p>SS 35 C</p>	 <p>N 92E</p>	 <p>ND 143G</p>	<p>TECTRON</p>  <p>T 812C</p>	 <p>T3 MS</p>
 <p>STY 128</p>	 <p>VN 45 HE</p>	 <p>N 95G</p>	 <p>ND 150G</p>	 <p>T 30MS</p>	
 <p>STY 129</p>	 <p>N 70 B</p>	 <p>N 95ED</p>	 <p>ND 200G</p>	<p>TELEFUNKEN</p>  <p>T 50HS</p>	
 <p>STY 136</p>	 <p>N 75-6</p>	<p>SONY</p>  <p>ND 15G</p>	 <p>ND 250G</p>	<p>TTSA</p>  <p>A 25/1</p>	<p>TOSHIBA</p>  <p>N 11C</p>
 <p>STY 144</p>	 <p>N 75-G</p>	 <p>ND 300G</p>	 <p>D 5107A</p>	 <p>A 25 SS</p>	 <p>N 20C</p>
 <p>STY 717</p>	 <p>N 75 EII</p>	 <p>ND 35E</p>	<p>STANTON</p>  <p>D 6800E</p>	 <p>T 50HS</p>	 <p>N 51</p>
<p>SHURE</p>  <p>N 17CM</p>	 <p>N 91 G</p>	 <p>ND 134G</p>	 <p>N 2001D</p>	 <p>T 50HS</p>	 <p>N 62</p>
	 <p>N 91 GD</p>	 <p>ND 136G</p>			

AUDIO IGLE ZA GRAMOFONE AUIG

TOSHIBA	KENWOOD
	
N 74C	N 54
	
N 280C	N 62
	VEB
N 290C	
	KS 23
N 292C	
KENWOOD	CS 24
	YAMAHA
N 39 II	
	N 6800
N 39 III	
	N 7700
N 47	
	N 8000
N 50	

18000 Niš, Jovana Ristića 7, P.O.Box 135, Tel: 018 / 520-455, 522-814, 522-965, fax: 522-660
<http://www.MGelectronic.co.yu> e-mail: office@MGelectronic.co.yu

AUDIO IGLE ZA GRAMOFONE AUIG

ADC

R 20X DR20X
RK 8 DRK8
RL 3 DRL3
RL 4 DRL4
RL 5 DRL5
RQ 3 DRQ3
RQ 4 DRQ4
RSQ 30 DRSQ30
RSQ 32 DRSQ32
RSQ 33 DRSQ33
RSX DRSX
RSX 5 DRSX5

AIWA

AN 2 DAN2
AN 10 DAN10
AN 11 DAN11
AN 30 DAN30
AN 50 DAN50
AN 60 DAN60

AKAI

RS 10 DRS10
RS 100 DRS100
RS 33 DRS33
RS 35 DRS35
RS 85 DRS85
RS 90 DRS90

AKG

X 4 DX4

AUDIO TEHNIKA

ATN 102EP DA102EP
ATN 102P DA102P
ATN 103 DA103
ATN 110E DA110E
ATN 12XE DA12XE
ATN 13 DA13
ATN 13EAV DA13EAV
ATN 2005 DA2005
ATN 3400 DA3400
ATN 3401 DA3401
ATN 3410 DA3410

AUDIO TEHNIKA

ATN 3450 DA3450
ATN 3472EP DA3472EP
ATN 3472 P DA3472P
ATN 3600 DA3600
ATN 3600L DA3600L
ATN 3601 DA3601
ATN 3606 DA3606
ATN 3651E DA3651E
ATN 3711 DA3711
ATN 3721 DA3721
ATN 3831 DA3831
ATN 51 DA51
ATN 70 DA70
ATN 70L DA70L
ATN 71 DA71B
ATN 71E DA71B
ATN 72 DA72
ATN 72E DA72E
ATN 750 DA750
ATN771 DA771
ATN 90 DA90
ATN 91 DA91
ATN 936 DA936
AT 557D DAT557D
ATPN 1 DATPN1
ATPN 2 DATPN2
ATS 10 DATS10
ATS 10L DATS10L
ATS 11 DATS11
ATS 12 DATS12
VM 35D DVM35D
VM 8 DVM8
AT 2005B SAT2005

AUE

SA 111-01 DSA11101

BSR

ST 12 AST12
ST 16 AST16
ST 20 AST20
TC 8RS ATC8RS
ST 17 DST17
SC 12M DSC12M

CEC

CZ 699 ACZ699
CZ 699S ACZ699
MC 17 DMC17
MC 20S DMC20S
MC 6S DMC6S
RS 3 DRS3

COLUMBIA

DSN 38 DDSN38
DSN 45 DDSN45
DSN 50 DDSN50
DSN 60 DDSN60
DSN 65 DDSN65
DSN 67 DDSN67

CONER

RCS S ARCS
33 S A33
RCS D DRCS
RCS SRCS

DUAL

DN 2S ADN2
DN 3S ADN3
DN 4S ADN4
DN 5S ADN5
DN 8 ADN8
DN 55S ADN55
DN 105 DDN105
DN 140S DDN140S
DN 145E DDN145E
DN 145S DDN145S
DN 149 S DDN149S
DN 152 E DDN152E
DN 155 E DDN155E
DN 160 E DDN160E
DN 163 E DDN163E
DN 165 E DDN165E
DN 166 E DDN166E
DN 167 DDN167
DN 168 E DDN168E
DN 201 DDN201
DN 211 DDN211
DN 221 DDN221

AUDIO IGLE ZA GRAMOFONE AUIG

ADC

R 20X	DR20X
RK 8	DRK8
RL 3	DRL3
RL 4	DRL4
RL 5	DRL5
RQ 3	DRQ3
RQ 4	DRQ4
RSQ 30	DRSQ30
RSQ 32	DRSQ32
RSQ 33	DRSQ33
RSX	DRSX
RSX 5	DRSX5

AIWA

AN 2	DAN2
AN 10	DAN10
AN 11	DAN11
AN 30	DAN30
AN 50	DAN50
AN 60	DAN60

AKAI

RS 10	DRS10
RS 100	DRS100
RS 33	DRS33
RS 35	DRS35
RS 85	DRS85
RS 90	DRS90

AKG

X 4	DX4
-----	-----

AUDIO TEHNIKA

ATN 102EP	DA102EP
ATN 102P	DA102P
ATN 103	DA103
ATN 110E	DA110E
ATN 12XE	DA12XE
ATN 13	DA13
ATN 13EAV	DA13EAV
ATN 2005	DA2005
ATN 3400	DA3400
ATN 3401	DA3401
ATN 3410	DA3410

AUDIO TEHNIKA

ATN 3450	DA3450
ATN 3472EP	DA3472EP
ATN 3472 P	DA3472P
ATN 3600	DA3600
ATN 3600L	DA3600L
ATN 3601	DA3601
ATN 3606	DA3606
ATN 3651E	DA3651E
ATN 3711	DA3711
ATN 3721	DA3721
ATN 3831	DA3831
ATN 51	DA51
ATN 70	DA70
ATN 70L	DA70L
ATN 71	DA71B
ATN 71E	DA71B
ATN 72	DA72
ATN 72E	DA72E
ATN 750	DA750
ATN771	DA771
ATN 90	DA90
ATN 91	DA91
ATN 936	DA936
AT 557D	DAT557D
ATPN 1	DATPN1
ATPN 2	DATPN2
ATS 10	DATS10
ATS 10L	DATS10L
ATS 11	DATS11
ATS 12	DATS12
VM 35D	DVM35D
VM 8	DVM8
AT 2005B	SAT2005

AUE

SA 111-01	DSA11101
-----------	----------

BSR

ST 12	AST12
ST 16	AST16
ST 20	AST20
TC 8RS	ATC8RS
ST 17	DST17
SC 12M	DSC12M

CEC

CZ 699	ACZ699
CZ 699S	ACZ699
MC 17	DMC17
MC 20S	DMC20S
MC 6S	DMC6S
RS 3	DRS3

COLUMBIA

DSN 38	DDSN38
DSN 45	DDSN45
DSN 50	DDSN50
DSN 60	DDSN60
DSN 65	DDSN65
DSN 67	DDSN67

CONER

RCS S	ARCS
33 S	A33
RCS D	DRCS
RCS	SRCS

DUAL

DN 2S	ADN2
DN 3S	ADN3
DN 4S	ADN4
DN 5S	ADN5
DN 8	ADN8
DN 55S	ADN55
DN 105	DDN105
DN 140S	DDN140S
DN 145E	DDN145E
DN 145S	DDN145S
DN 149 S	DDN149S
DN 152 E	DDN152E
DN 155 E	DDN155E
DN 160 E	DDN160E
DN 163 E	DDN163E
DN 165 E	DDN165E
DN 166 E	DDN166E
DN 167	DDN167
DN 168 E	DDN168E
DN 201	DDN201
DN 211	DDN211
DN 221	DDN221

AUDIO IGLE ZA GRAMOFONE AUIG

DUAL		ELAC		KENWOOD	
DN 236	DDN236	D 355-17	DD35517	N 52	DN52
DN 237	DDN237	D 792 E	DD792E	N 54	DN54
DN 239	DDN239	D 793	DD793	N 62	DN62
DN 242	DDN242	D 793 E	DD793E	N 63	DN63
DN 245	DDN245	D 794 E	DD794E	N 64	DN64
DN 249 E	DDN249E	D 795 E	DD795E	N 66	DN66
DN 251 S	DDN251S	D 796 E	DD796E	N 67	DN67
DN 251E	DDN251E	DM 240	DDM240	N 68	DN68
DN 305	DDN305	SM 103	ASM103	N 71	DN71
DN 320	DDN320	SNM 9	ASNM9	N 72	DN72
DN 321	DDN321	SNM 102	ASNM102	N 77	DN77
DN 325	DDN325	SNM 106	ASNM106		
DN 330	DDN330	SNM 112	ASNM112	LENCO	
DN 340	DDN340			M 94	DM94
DN 345	DDN345	EMPIRE		M 100	DM100
DN 350	DDN350	S 66 X	DS66X	M 300	DM300
DN 352	DDN352	S 2000	DS2000	M 350	DM350
DN 353	DDN353	S 2000 E	DS2000E	M 400	DM400
DN 360	DDN360	S 2000 Z	DS2000Z		
DN 362	DDN362			LUXOR	
DN 365	DDN365	EXCEL		65977 S	ALUXOR
DN 380 E	DDN380E	N 700 CR	DN700CR	65977 D	DLUXOR
DN 390 E	DDN390E	S 55	DS55		
DN 450	DDN450	S 70 SR	DS70SR	MARANTZ	
DN 750	DDN750			CT 100	DCTM100
DMS 251 S	SDMS251S	GOLDRING		CT 221	DCTM221
DMS 251 E	SDMS251E	D 120/850	DD120	CT 520	DCT520
MMP 450	SMMP450			CT 551	DCT551
PE 188	SPE188	HITACHI			
PE 190	SPE190	DSST 12	DDSST12	MICRO	
TK 24	ZTK24	DSST 14	DDSST14	V 3300/A	DV3300A
TK 26	ZTK26	DSST 15	DDSST15	V-P1	DVP1
TK 27	ZTK27	DSST 30	DDSST30		
ULM 65 E		DSST 40	DDSST40	NAGAOKA	
ULM 66 E	SULM66E	DSST 101	DDSST101	JN 311	DJN311
UMR STSATZT	ZUMRTKS	DSST 102	DDSST102		
UMR STSATZG	ZUMRG	DSST 103	DDSST103	NATIONAL	
				EPS 23 CS	DEPS23CS
ELAC		KENWOOD		EPS 23 ES	DEPS23ES
D 144-17	DD14417	N 39 II	DN392	EPS 24 CS	DEPS24CS
D 155-17	DD15517	N 39 III	DN393	EPS 24 ES	DEPS24ES
D 244-17	DD24417	N 47	DN47	EPS 25 CS	DEPS24CS
D 255-17	DD25517	N 49	DN49	EPS 25 ES	DEPS24ES
D 344-17	DD34417	N 50	DN50	EPS 27 CS	DEPS27CS

AUDIO IGLE ZA GRAMOFONE AUIG
NATIONAL

EPS 27 STD DEPS27
 EPS 28 ES DEPS28ES
 EPS 30 CS DEPS30CS
 EPS 30 ES DEPS30ES
 EPS 33 CS DEPS33CS
 EPS 33 ES DEPS33ES
 EPS 34 CS DEPS34CS
 EPS 36 STSD DEPS36
 EPS 41 STSD DEPS41
 EPS 202 ED DEPS202
 EPS 205 ED DEPS205D
 EPS 206 ED DEPS206
 EPS 207 DEPS207D
 EPS 270 ED DEPS270E
 EPS 270 SD DEPS270S

NIVICO

DT 33 H DDT33H
 DT 36 DDT36
 DT 37 L DDT37
 DT 41 DDT41
 DT 45 DDT45
 DT 51 DDT51
 DT 51 S ADT51
 DT 55 B DDT55B
 DT 58 DDT58
 DT 59 DDT59
 DTZ 1 S DDTZ1S
 DTZ 5 S DDTZ5S
 ST 51 M.DIA SST51D

ONKYO

DN 39 ST DDN39
 DN 56 ST
 DN 70 ST DDN70ST
 DN 74 ST DDN74ST

ORTOFON

D 10E II DD10E2
 D 20E II DD20E2
 N 15 DN15
 N 15 II DN152
 N 15 E DN15E
 N 15 E II DN15E2

ORTOFON

N 20 E DN20E
 NF 15 DNF15
 NF 15 II DNF152
 NF 15 X II DNF15X2
 NF 15 XE II DNF15XE2
 NSM DNSM
 NADEL 5 D5
 NADEL 10 D10
 NADEL 20 D20
 MAG 2 E DMAG2E

PE

PE 10 MMS APE10MM
 PE 45/90 NS APE4590N
 PE 188 NS APE188N
 PE 190 MS APE190M
 PE 192 MS APE192MS

PHILIPS

946/S 46 S A946S46
 946/S 50 S A946S50
 946/SS 50 S A946SS50
 946/SS 63 S A946SS63
 946/D 58 D946D58
 946/D 59 D946D59
 946/D 60 D946D60
 946/D 64 D946D64
 946/D 65 D946D65
 946/D 66 D946D66
 946/D 67 D946D67
 946/D 69 D946D69
 946/D 70 D946D70
 946/D 71 D946D71
 946/D 74 D946D74
 946/D 75 D946D75
 946/D 76 D946D76
 946/DS 51 D946DS51
 GP 204/205 SGP205N
 GP 215 SGP215N
 GP 230/235 SGP230

PICKERING

D 1507 AC2 DD1507AC
 D625E DD625E

PIEZO

AN 121 DAN121
 AN 308 II DAN3082

PIONEER

PN 3 MC DPN3MC
 PN 5 MC DPN5MC
 PN 12 DPN12
 PN 30 ST DPN30ST
 PN 110 DPN110
 PN 110 II DPN1102
 PN 135 DPN135
 PN 150 DPN150
 PN 200 DPN200
 PN 210 DPN210
 PN 220 DPN220
 PN 230 DPN230
 PN 240 DPN240
 PN 250 T DPN250T
 PN 260 DPN260
 PN 290 T DPN290T
 PN 295 T DPN295T
 PN 300 DPN300
 PN K 65 DPNK65

RONETTE

BF 40 S ABF40
 SC 109 S ASC109

SANSUI

SN 26 DSN26
 SN 28 DSN28
 SN 37 DSN37
 SN 60 DSN60
 SN 80 DSN80
 SN 303 DSN303
 SN 313 DSN313
 SN 505 DSN505
 SN 707 DSN707
 SN P 212 DSNP212

SANYO

ST 05 AST05
 ST 05 D DST05D
 ST 07 D DST07D

AUDIO IGLE ZA GRAMOFONE AUIG

SANYO

ST 09 D DST09D
ST 10 J DST10J
ST 28 D DST28D
ST 29 D DST29D
ST 35 D DST35D
ST 37 D DST37D
ST 38 D DST38D
ST 41 D DST41D
ST 44 D DST44D
ST 44 J DST44J
ST 55 D DST55D
ST 66 D DST66D
ST 100 SD DST100SD
ST 101 SD DST101SD
ST 103 SD DST103SD
ST G 6 DSTG6
ST G 9 DSTG9
ST G 10 DSTG10

SHARP

SG 35 H DSG35H
STY 101 DSTY101
STY 102 DSTY102
STY 104 DSTY104
STY 113 DSTY113
STY 116 DSTY116
STY 117 DSTY117
STY 121 DSTY121
STY 124 DSTY124
STY 127 DSTY127
STY 128 DSTY128
STY 129 DSTY129
STY 133 DSTY133
STY 136 DSTY136
STY 137 DSTY137
STY 144 DSTY144
STY 155 DSTY155
STY 717 DSTY717

SHURE

N 17 CM DN17CM
N 44-7 DN447
N 44 C DN44C
N 44 G DN44G

SHURE

N 55 E DN55E
N 70 B DN70B
N 72 B DN72B
N 75-3 DN753
N 75-6 DN756
N 75 C DN75C
N 75 ED II DN75ED2
N 75 G DN75G
N 77 DN77
N 91 E DN91E
N 91 ED DN91ED
N 91 G DN91G
N 91 GD DN91GD
N 92 E DN92E
N 95 ED DN95ED
N 95 G DN95G
N 95 HE DN95HE
N 99 E DN99E
N 104 E DN104E
SS 35 C DSS35C
VN 15 E DVN15E
VN 35 E DVN35E
VN 45 HE DVN45HE

SONOTONE

DKN 100 DDKN100

SONY

ND 15 G DND15G
ND 35 E DND35E
ND 134 G DND134G
ND 136 G DND136G
ND 137 G DND137G
ND 138 G DND138G
ND 142 G DND142G
ND 143 G DND143G
ND 150 G DND150G
ND 155 G DND155G
ND 200 E DND200E
ND 200 G DND200G
ND 250 G DND250G
ND 300 G DND300G

STANTON

D 680 E DD680E
D 5100 E DD5100E
D 5100 EE DD5100EE

TELEFUNKEN

A 22/SS AA22SS
A 23/1 A231
A 23/2 AA232
A 25/1 AA251S
A 25/2 AA252
A 25/SS A25SS
TTSA ATTSA
A 400 D DA400D
A 500 D DA500D
T 25/2 ST252

TOSHIBA

N 11 C DN11C
N 51 C DN51TO
N 58 C DN58C
N 62 C DN62
N 74 C DN74C
N 280 C DN280C
N 290 C DN290C
N 292 C DN292C
N 320 D DN320D

VEB

CS 24 ACS24
CS 29 ACS29
KS 22 AKS22
KS 23 AKS23

YAMAHA

N 6800 DN6800
N 7700 DN7700
ST 103 SD DST103SD
ST G 6 DSTG6
ST G 9 DSTG9
ST G 10 DSTG10

AUDIO

AU

AUDIO IGLE ZA GRAMOFONE AUIG

TIP	OPIS	CENA	TIP	OPIS	CENA
A231	TELEFUNKEN A23/1	11.00	AT2M	TEETRAD T2-MS	11.00
A25SS	TELEFUNKEN A25/SS	11.00	AT3M	TETRAD T3-MS	11.00
A33	CONER 33S	16.00	AT30M	TETRAD T30-MS	11.00
A946S46	PHILIPS A946S46	11.00	AT50H	TETRAD T50-HS	11.00
A946S50	PHILIPS A946S50	11.00	ATC8RS	BSR TC8RS	11.00
A946SS50	PHILIPS A946SS50	15.00	ATTSA	TELEFUNKEN TTSA/TT	11.00
A946SS63	PHILIPS A946SS63	11.00	D5	ORTOFON NADEL 5	23.00
AA22SS	TELEFUNKEN A22/SS	11.00	D10	ORTOFON 10/CL10	33.00
AA232	TELEFUNKEN A23/2	11.00	D20	GO TO. D10	
AA251S	TELEFUNKEN A25/1	11.00	D946D58	GO TO. D946D59	
AA252	TELEFUNKEN A25/2	11.00	D946D59	PHILIPS 946/D59	32.00
ABF40	RONETTE BF40S	11.00	D946D60	PHILIPS 946/D60	22.00
ACS24	VEB CS24	11.00	D946D64	GO TO. DSTY117	
ACS29	VEB CS29	11.00	D946D65	PHILIPS 946/D65	23.00
ACZ699	CEC CZ-699S	13.00	D946D66	GO TO. D946D65	
ADN2	DUAL DN2S	10.00	D946D67	GO TO. D946D65	
ADN3	DUAL DN3S	10.00	D946D69	PHILIPS 946/D69	26.00
ADN4	DUAL DN4S	10.00	D946D70	GO TO. D946D69	
ADN5	DUAL DN5S	10.00	D946D74	PHILIPS 946/D74	24.00
ADN8	DUAL DN8S	14.00	D946D75	GO TO. D946D74	
ADN55	DUAL DN55S	10.00	D946D76	GO TO. D946D74	
ADT51	NIVICO DT-51S	10.00	D946DS51	PHILIPS 946/DS51	11.00
AKS22	VEB KS22	11.00	DA12XE	AUDIO TECH ATN12XE	39.00
AKS23	VEB KS23	15.00	DA13	GO TO. DA13EAV	
AKS40	GARRARD KS40	11.00	DA13EAV	AUDIO TECH ATN12XE	34.00
ALUXOR	LUXOR 65977S	11.00	DA51	AUDIO TECH ATN51	24.00
APE10MM	PE 10MM	11.00	DA70	GO TO. DA71B	
APE188N	PE 188N	11.00	DA70L	GO TO. DA71B	
APE190M	PE 190M	11.00	DA71B	AUDIO TECH ATN71	19.00
APE192MS	PE 192MS	11.00	DA71EB	AUDIO TECH ATN71EB	33.00
APE4590N	PE 4590N	11.00	DA72	GO TO. DA71B	
ARCS	CONER RCS S	11.00	DA72E	GO TO. DA71EB	
ASC109	RONETTE SC109S	11.00	DA90	GO TO. DA91	
ASM103	ELAC SM103	11.00	DA91	AUDIO TECH ATN91	19.00
ASNM9	ELAC SNM9	11.00	DA102EP	AUDIO TECH ATN102EP	32.00
ASNM102	ELAC SNM102	11.00	DA102P	AUDIO TECH ATN102P	24.00
ASNM106	ELAC SNM106	11.00	DA103	AUDIO TECH ATN103	34.00
ASNM112	ELAC SNM112	11.00	DA105	AUDIO TECH ATN110E	44.00
AST05	SANYO ST-05	7.00	DA110E	GO TO. DA105	
AST12	BSR ST12	9.00	DA400D	GO TO. DS70SR	
AST16	BSR ST16	9.00	DA500D	GO TO. DN700CR	
AST20	BSR ST20	9.00	DA750	GO TO. DN6800	

18000 Niš, Jovana Ristića 7, P.O.Box 135, Tel: 018 / 520-455, 522-814, 522-965, fax: 522-660
<http://www.MGelectronic.co.yu> e-mail: office@MGelectronic.co.yu

AUDIO

AU

AUDIO IGLE ZA GRAMOFONE AUIG

TIP	OPIS	CENA	TIP	OPIS	CENA
DA771	GO TO. DA71B		DD793	ELAC D793	57.00
DA936	AUDIO TECH ATN936	33.00	DD793E	GO TO. DD792E	
DA2005	GO TO. DDN239		DD794E	GO TO. DD792E	
DA3400	AUDIO TECH ATN3400	19.00	DD795E	GO TO. DD792E	
DA3401	GO TO. DA3400		DD796E	GO TO. DD792E	
DA3410	GO TO. DA3400		DD1507AC	PICKERING D1507AC2	21.00
DA3450	GO TO. DA3400		DD5100E	STANTON D5100E	37.00
DA3472EP	AUDIO TECH ATN3742EP	33.00	DD5100EE	STANTON D5100EE	37.00
DA3472P	AUDIO TECH ATN3472P	19.00	DD5107A	STANTON D5107A	26.00
DA3600	AUDIO TECH ATN3600	19.00	DD5107AL	GO TO. DD5107A	
DA3600L	GO TO. DA3600		DD6800EE	STANTON D6800EE	62.00
DA3601	GO TO. DA91		DD6807A	STANTON D6807A	48.00
DA3606	AUDIO TECH ATN3606	42.00	DD15517	ELAC D155-17	28.00
DA3651E	AUDIO TECH ATN3651E	33.00	DD25517	GO TO. DD15517	
DA3711	AUDIO TECH ATN3711	20.00	DD35517	GO TO. DD15517	
DA3721	AUDIO TECH ATN3721	28.00	DDKN100	SONOTONE DKN100	30.00
DA3831	GO TO. DSTY124		DDN15	ORTOFON NF15 SERIE	46.00
DAN2	AIWA AN-2	30.00	DDN39	ONKYO DN-39ST	26.00
DAN10	GO TO. DSTG9		DDN56ST	ONKYO DN-56ST	24.00
DAN11	DDN239		DDN70ST	GO TO. DSTY102	
DAN30	AIWA AN-30	25.00	DDN74ST	GO TO. DDN105	
DAN50	GO TO. DSTY124		DDN105	DUAL DN105	33.00
DAN60	AIWA AN-60	27.00	DDN140S	DUAL DN140S	28.00
DAN121	PIEZO AN-121/122	20.00	DDN145E	GO TO. DDN155E	
DAN3082	GO TO. DDSST103		DDN145S	GO TO. DDN140S	
DAT557D	AUDIO TECH AT55-7D	25.00	DDN149S	GO TO. DDN140S	
DATPN1	AUDIO TECH ATPN1	30.00	DDN152E	GO TO. DDN155E	
DATPN2	GO TO. DATPN1		DDN155E	DUAL DN155E	38.00
DATS10	GO TO. DATS11		DDN160E	GO TO. DDN155E	
DATS10L	GO TO. DATS11		DDN165E	DUAL DN165E	32.00
DATS11	AUDIO TECH ATS11	21.00	DDN166E	DUAL DN166E	32.00
DATS12	AUDIO TECH ATS12	33.00	DDN201	DUAL DN201	24.00
DCT520	MARANTZ CT-520	54.00	DDN211	DUAL DN211	24.00
DCT551	MARANTZ CT-551	36.00	DDN221	DUAL DN221	24.00
DCTM100	MARANTZ CT-100	36.00	DDN236	DUAL DN236	24.00
DCTM221	GO TO. DN292C		DDN237	GO TO. DDN236	
DD10E2	GO TO. DN15E2		DDN239	DUAL DN239	19.00
DD20E2	ORTOFON D20E2	36.00	DDN242	DUAL DN242	34.00
DD120	GOLDRING D120/850	31.00	DDN245	DUAL DN245	30.00
DD625E	PICKERING D625E	43.00	DDN301	DUAL DN301	36.00
DD680E	STANTON D680E	62.00	DDN305	GO TO. DN44C	
DD792E	ELAC D792E	58.00	DDN320	DUAL DN320	20.00

AUDIO

AU

AUDIO IGLE ZA GRAMOFONE AUIG

TIP	OPIS	CENA	TIP	OPIS	CENA
DDN321	DUAL DN321	32.00	DEPS27	NATIONAL EPS-27STS	19.00
DDN325	DUAL DN325	19.00	DEPS27CS	NATIONAL EPS-27CS	22.00
DDN330	DUAL DN330	20.00	DEPS28ES	GO TO. DEPS202	
DDN340	GO TO. DDN330		DEPS30CS	NATIONAL EPS-30CS	24.00
DDN345	DUAL DN345	32.00	DEPS30ES	NATIONAL EPS-30ES	34.00
DDN350	DUAL DN350	39.00	DEPS33CS	NATIONAL EPS-33CS	24.00
DDN352	DUAL DN352	34.00	DEPS33ES	NATIONAL EPS-33ES	34.00
DDN353	DUAL DN353	26.00	DEPS34CS	GO TO. DDT45	
DDN360	DUAL DN360	23.00	DEPS36	NATIONAL EPS-36ST	11.00
DDN362	DUAL DN362	34.00	DEPS41	NATIONAL EPS-41STS	11.00
DDN380E	DUAL DN380E	72.00	DEPS202	NATIONAL EPS-202ED	33.00
DDN390E	GO TO. DDN380E		DEPS205D	GO TO. DEPS207D	
DDN450	GO TO. DA3472P		DEPS206	GO TO. DEPS207D	
DDSN45	GO TO. DDT51		DEPS207D	NATIONAL EPS-207ED	42.00
DDSN50	COLUMBIA DSN-50	38.00	DEPS270E	NATIONAL EPS-270ED	33.00
DDSN60	COLUMBIA DSN-60	56.00	DEPS270S	NATIONAL EPS-270SD	20.00
DDSN65	GO TO. DDSN60		DLUXOR	LUXOR 65977D	15.00
DDSN67	GO TO. DST29D		DM100	GO TO. DS70SR	
DDSST12	GO TO. DDT45		DM300	LENCO M300	48.00
DDSST14	GO TO. DDT45		DM350	LENCO M350	48.00
DDSST30	GO TO. DA71B		DM94	LENCO M94	26.00
DDSST40	HITACHI DS-ST40	23.00	DMAG2E	GO TO. DDN155E	
DDSST101	HITACHI DS-ST101	20.00	DMC6S	CEC MC-6S/BW2	18.00
DDSST102	HITACHI DS-ST102	23.00	DMC17	GO TO. DS55	
DDSST103	HITACHI DS-ST103	26.00	DMC20S	CEC MC-20S	24.00
DDT33H	NIVICO DT-33H	24.00	DN11C	TOSHIBA N-11C	11.00
DDT36	NIVICO DT-36	27.00	DN15	ORTOFON N15 UNIV.	26.00
DDT37	NIVICO DT-37L	28.00	DN15E	GO TO. DN15E2	
DDT41	NIVICO DT-41	36.00	DN15E2	ORTOFON N15E2	36.00
DDT45	NIVICO DT-45	19.00	DN17CM	SHURE N17CM	42.00
DDT51	NIVICO DT-51	11.00	DN20E	GO TO. DDN350	
DDT55B	NIVICO DT-55B	28.00	DN44C	SHURE N44C	22.00
DDT58	GO TO. DA3600		DN44G	GO TO. DN44C	
DDT59	GO TO. DDT55B		DN47	GO TO. DSTY101	
DDTZ1S	NIVICO DT-Z1S	20.00	DN49	GO TO. DST10J	
DDTZ5S	NIVICO DT-Z5S	30.00	DN50	KENWOOD N-50	26.00
DEPS23CS	NATIONAL EPS-23CS	22.00	DN51TO	TOSHIBA N-51C	20.00
DEPS23ES	GO TO. DEPS202		DN52	DA3400	
DEPS24CS	NATIONAL ES-24CS	24.00	DN54	KENWOOD N-54	32.00
DEPS24ES	GO TO. DEPS202		DN55E	SHURE N55E	32.00
DEPS25CS	NATIONAL EPS-25CS	22.00	DN58C	TOSHIBA N-58C	32.00
DEPS25ES	GO TO. DEPS202		DN62	TOSHIBA N-62C	20.00

18000 Niš, Jovana Ristića 7, P.O.Box 135, Tel: 018 / 520-455, 522-814, 522-965, fax: 522-660
<http://www.MGelectronic.co.yu> e-mail: office@MGelectronic.co.yu

AUDIO

AU

AUDIO IGLE ZA GRAMOFONE AUIG

TIP	OPIS	CENA	TIP	OPIS	CENA
DN62T	KENWOOD N-62	33.00	DND136G	GO TO. DA71B	
DN63	GO TO. DDT45		DND137G	SONY ND-137G	24.00
DN64	KENWOOD N-64	30.00	DND138G	GO TO. DA3400	
DN66	GO TO. DSN80		DND142G	GO TO. DA91	
DN67	GO TO. DSNP212		DND143G	SONY ND-143G	29.00
DN68	GO TO. DST66D		DND150G	SONY ND-150G	24.00
DN70B	SHURE N70B	21.00	DND155G	GO TO. DA3600	
DN72	GO TO. DSN80		DND200E	SONY ND-200E	24.00
DN72B	GO TO. DN70B		DND200G	GO TO. DND250G	
DN74C	TOSHIBA N-74C	36.00	DND250G	SONY ND-250G	24.00
DN75C	SHURE N75C	23.00	DND300G	SONY ND-300G	33.00
DN75G	GO TO. DDN320		DNF15	GO TO. DDN15	
DN75ED2	SHURE N75EDII	32.00	DNF15X2	GO TO. DDN15	
DN77	SHURE N77	40.00	DNF15XE2	GO TO. DN15E2	
DN77K	GO TO. DA3606		DNF152	GO TO. DDN15	
DN91E	GO TO. DDN345		DNSM	ORTOFON NSM	28.00
DN91ED	GO TO. DDN345		DPN12	GO TO. DPN110	
DN91G	GO TO. DDN330		DPN102	GO TO. DPN110	
DN91GD	GO TO. DDN330		DPN110	PIONEER PN-110	27.00
DN92E	SHURE N92E	34.00	DPN135	PIONEER PN-135	30.00
DN95ED	GO TO. DDN362		DPN150	GO TO. DPN110	
DN95G	SHURE N95G	23.00	DPN200	PIONEER PN-200	32.00
DN95HE	GO TO. DDN362		DPN210	GO TO. DA3600	
DN99E	GO TO. DN92E		DPN220	GO TO. DA3400	
DN104E	GO TO. DN92E		DPN230	GO TO. DA3400	
DN152	GO TO. DN15E2		DPN240	GO TO. DA3600	
DN280C	TOSHIBA N-280C	24.00	DPN250T	GO TO. DRS33	
DN290C	GO TO. DN280C		DPN260	GO TO. DA71B	
DN292C	TOSHIBA N-292C	20.00	DPN290T	PIONEER PN290T	25.00
DN320D	TOSHIBA N-320D	20.00	DPN295T	GO TO. DA3472P	
DN392	KENWOOD N-39II	26.00	DPN300	GO TO. DPN290T	
DN393	KENWOOD N-39III	25.00	DPN305T	GO TO. DRS33	
DN447	GO TO. DN44C		DPN3MC	PIONEER PN-3MC	180.00
DN700CR	EXCEL N700CR	25.00	DPN5MC	PIONEER PN-5MC	225.00
DN753	GO TO. DDN321		DPNK65	GO TO. DAN60	
DN756	SHURE N75-6	19.00	DR20X	ADC R20X	32.00
DN2001D	TENOREL N-2001D	26.00	DRCS	CONER RCS D	11.00
DN6800	YAMAHA N-6800	25.00	DRK8	GO TO. DRSQ30	
DN7700	GO TO. DA3600		DRL3	ADC RL3	24.00
DND15G	SONY ND-15G/XL-15	26.00	DRL4	GO TO. DRL3	
DND35E	SONY ND-35E	32.00	DRL5	GO TO. DRL3	
DND134G	SONY ND-134G	22.00	DRQ3	GO TO. DRQ4	

AUDIO

AU

AUDIO IGLE ZA GRAMOFONE AUIG

TIP	OPIS	CENA	TIP	OPIS	CENA
DRQ4	ADC RQ4	24.00	DST44D	SANYO ST-44D	32.00
DRS3	CEC RS-3	28.00	DST44J	GO TO. DDT45	
DRS10	AKAI RS-10	32.00	DST55D	GO TO. DA3400	
DRS33	AKAI RS-33	19.00	DST66D	SANYO ST-66D	27.00
DRS35	GO TO. DRS33		DST100SD	SANYO ST-100SD	33.00
DRS85	GO TO. DA3400		DST101SD	SANYO ST-101SD	30.00
DRS90	GO TO. DA3711		DST103SD	GO TO. DSTY124	
DRS100	GO TO. DDSST103		DSTG6	GO TO. DDT51	
DRSQ30	ADC RSQ-30	20.00	DSTG9	SANYO ST-G9	22.00
DRSQ32	ADC RSQ-32	30.00	DSTG10	SANYO ST-G10	22.00
DRSQ33	GO TO. DRSQ30		DSTY101	SHARP STY-101	25.00
DRSX	ADC RSX	30.00	DSTY102	SHARP STY-102	25.00
DRSX5	ADC RSX 5	30.00	DSTY104	GO TO. DSN37	
DS55	EXCEL S55/ME55	28.00	DSTY113	SHARP STY-113	09.00
DS66X	EMPIRE S66X	26.00	DSTY116	SHARP STY-116	25.00
DS70SR	EXCEL S70SR	20.00	DSTY117	SHARP STY-117	24.00
DS2000	EMPIRE S-2000	30.00	DSTY121	GO TO. DA3721	
DS2000E	EMPIRE S-2000E	38.00	DSTY124	SHARP STY-124	24.00
DS2000Z	EMPIRE S-2000Z	49.00	DSTY127	GO TO. DN292C	
DSA11101	AUE SA111-01	20.00	DSTY128	GO TO. DSTG35H	
DSG35H	SHARP SG-35H	34.00	DSTY129	SHARP STY-129	30.00
DSN26	SANSUI SN-26	26.00	DSTY133	GO TO. DSTY129	
DSN37	SANSUI SN-37	23.00	DSTY136	GO TO. DAN30	
DSN41	SANSUI N-41	25.00	DSTY137	GO TO. DAN30	
DSN60	GO TO. DSN80		DSTY144	SHARP STY-144	36.00
DSN80	SANSUI SN-80	20.00	DSTY155	GO TO. DDT55B	
DSN303	SANSUI SN-303	26.00	DSTY717	SHARP STY-717	24.00
DSN505	SANSUI SN-505	30.00	DT812S	TECTRON T812C	30.00
DSN707	SANSUI SN-707	27.00	DUFN70	PHILIPS UF-N70D	21.00
DSNP212	SANSUI SN-P212	34.00	DV3300A	MICRO V-3300/A	30.00
DSS35C	SHURE SS35C	30.00	DVM8	GO TO. DATS11	
DST05D	SANYO ST-05D	9.00	DVM35D	AUDIO TECH VM3-5D	27.00
DST07D	SANYO ST-07D	32.00	DVM2102	SUPRAPHON VM-2102	49.00
DST09D	SANYO ST-09D	20.00	DVN35E	SHURE VN35E	36.00
DST10J	SANYO ST-10J	21.00	DVN45HE	SHURE VN45HE	128.0
DST17	BSR ST17	11.00	DX4	AKG X4	36.00
DST28D	SANYO ST-28D	20.00	SAT2005	AUDIO TECH AT2005B	58.00
DST29D	SANYO ST-29D	21.00	ST252	TELEFUNKEN T25/2	30.00
DST35D	GO TO. DA3400		STYLUS-1203	GO TO. DK-DA91	
DST37D	GO TO. DAN60		TONAR511DE	GO TO. DK-D946D60	
DST38D	SANYO ST-38D	30.00	TONAR 543D	GO TO. DK-A946SS50	
DST41D	GO TO. DN6800		TONAR 573	GO TO: DK-DSN26	

18000 Niš, Jovana Ristića 7, P.O.Box 135, Tel: 018 / 520-455, 522-814, 522-965, fax: 522-660
<http://www.MGelectronic.co.yu> e-mail: office@MGelectronic.co.yu

TELESKOP ANTENE AUANT



Tip	R	A	B	Cena
10	7	163	793	3,00
11	6	154	686	3,00
12	6	176	703	3,00
13	7	195	795	3,00
14	6	212	979	3,00
15	6	233	950	3,00
16	6	271	861	3,00
17	6	258	874	3,00
18	6	279	955	3,00
19	6	304	1066	3,00
20	6	347	1236	3,00

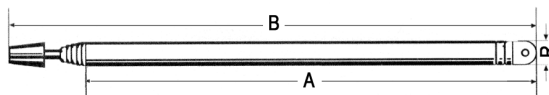

Tip	R	A	B	Cena
34	8	159	851	6,00



Tip	R	A	B	Cena
30	8	137	653	5,00



Tip	R	A	B	Cena
35	7	159	717	6,00



Tip	R	A	B	Cena
31	8	138	672	6,00



Tip	R	A	B	Cena
36	8	162	790	6,00



Tip	R	A	B	Cena
32	10	142	865	6,00



Tip	R	A	B	Cena
37	9	179	924	6,00



Tip	R	A	B	Cena
33	8	146	680	3,00



Tip	R	A	B	Cena
38	10	191	995	7,00

TELESKOP ANTENE. AUANT



Tip	R	A	B	Cena
39	8.5	168	937	6,00



Tip	R	A	B	Cena
58	6	324	878	3,00



Tip	R	A	B	Cena
40	7	194	977	3,50



Tip	R	A	B	Cena
59	7	237	1010	4,00



Tip	R	A	B	Cena
41	9	163	816	5,00



Tip	R	A	B	Cena
60	6	122	446	4,00



Tip	R	A	B	Cena
42	9	170	820	6,00



Tip	R	A	B	Cena
61	6	111	403	3,00



Tip	R	A	B	Cena
55	6	196	911	3,00



Tip	R	A	B	Cena
63	9	179	922	3,50



Tip	R	A	B	Cena
56	7	238	1315	3,50



Tip	R	A	B	Cena
64	5	109	319	3,00

TELESKOP ANTENE AUANT



Tip	R	A	B	Cena
65	5	123	448	3,00



Tip	R	A	B	Cena
71	7	150	780	3,00



Tip	R	A	B	Cena
66	6	113	400	3,50



Tip	R	A	B	Cena
72	6	124	384	3,00



Tip	R	A	B	Cena
68	8	165	1025	4,00



Tip	R	A	B	Cena
73	6	98	42	3,00



Tip	R	A	B	Cena
69	7	108	358	3,00



Tip	R	A	B	Cena
74	6	96	42	3,00



FM - UKT ANTENE AUANT



Tip	Cena
104	5,00



Tip	Cena
105	6,00

AUDIO

AU

MIKROFONI

AUMI

M4

Tehnički podaci:
Dinamički mikrofoni:
Impedansa: 600 Ω
Učestalost: 100 - 12500 Hz
Utikač: Ø 6,3
Du ina kabla: 2 m
Cena:14,00



M6

Tehnički podaci:
Dinamički mikrofoni:
Impedansa: 600 Ω
Učestalost: 80 - 14000 Hz
Utikač: Ø 6,3
Du ina kabla: 3 m
Cena:28,00



M7

Tehnički podaci:
Dinamički mikrofoni:
Impedansa: 600 Ω
Učestalost: 50 - 18000 Hz
Utikač: Ø 6,3
Du ina kabla: 5 m
Cena:56,00



SLUŠALICE

AUSL

Tehnički podaci:
Impedansa: 32 Ω
Učestalost: 20 - 20000 Hz
Osetljivost: 84 dB / 1KHz
Utikač: Ø 3,5
Du ina kabla: 1,2 m



MP 13 5,00
HP 100 9,00
RIH 753 18,00

CD 38. 13,00
CD 98. 14,00
HP 110 12,00

FH 5 24,00
FH 6 38,00

18000 Niš, Jovana Ristića 7, P.O.Box 135, Tel: 018 / 520-455, 522-814, 522-965, fax: 522-660
http://www.MGelectronic.co.yu e-mail: office@MGelectronic.co.yu