

KABLOVI **Kab**

PROVODNICI
MIKROFONSKI KABLOVI
ANTENSKI-KOAKSIJALNI KABLOVI
AUDIO-VIDEO KABLOVI
OPTIČKI KABLOVI
KABLOVI ZA SONY PLAYSTATION
KABLOVI ZA AUTOMOBILE
KABLOVI ZA ZVUČNIKE
MREZNI KABLOVI
KABLOVI ZA KOMPJUTERE
KABLOVI FIREWIRE
KABLOVI ZA INSTRUMENTE
MERNI KABLOVI
TELEFONSKI KABLOVI
UVODNICI ZA KABLOVE
OBUJMICE ZA KABLOVE
DRŽAČI ZA KABLOVE
UŠICE ZA PROVODNIKE
KABLOVSKE STOPICE
OZNAKE ZA OBELEZAVANJE KABLOVA
TERMO-BUZIRI ZA KABLOVE
PVC BUZIRI ZA KABLOVE

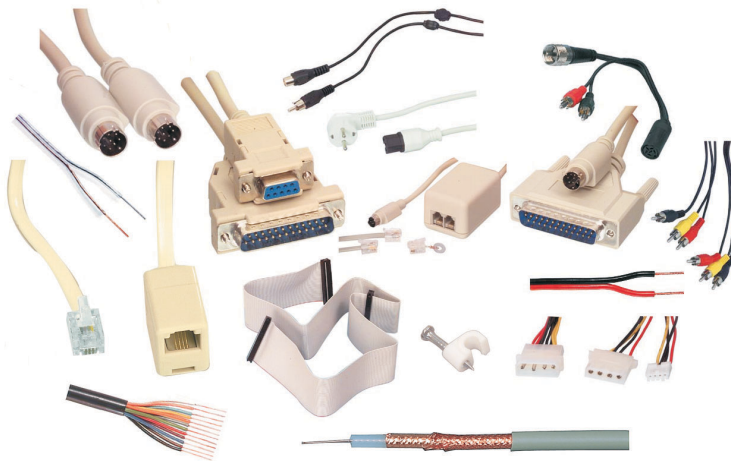

KABLOVI

KAB

PROVODNICI KABP

LICNAŠTI KABPL

Tehnički podaci:

Tip: TM 70

Primena: Za ostvarivanje unutrašnjih veza u telekomunikacionim, signalnim i mernim uređajima

Konstrukcija: Fino ična uzica od od arene kalajisane bakarne ize izolacija od bešavnog sloja PVC mase standardnih boja

Nazivni napon: 200 V

Ispitni napon: 2000 V

Temperaturni opseg: -10°C ... +70°C



Tip	Cena	Nazivni presek provodnika (mm ²)	Konstrukcija provodnika broj x preč. ize (mm)	Nominalna debljina izolacije (mm)	Najveći spoljni prečnik (mm)	Najveća električna otpornost (Ω/km)	Masa monta nog provodnika, pribli no (kg/km)
0,25	0,20	0,25	7 x 0,20	0,32	1,3	88	3,50
0,5	0,30	0,50	16 x 0,20	0,35	1,7	38,2	6,80
0,75	0,40	0,75	24 x 0,20	0,34	2,0	25,5	9,40
1,00	0,50	1,00	32 x 0,20	0,42	2,4	19,1	12,80

SILIKONSKI KABPS

Tehnički podaci:

Primena: Za ostvarivanje unutrašnjih veza u uređajima koji rade na većim temperaturama

Konstrukcija: Fino ična uzica od od arene kalajisane bakarne ize izolacija od silikonske mase

Nazivni napon: 500 V

Ispitni napon: 3000 V

Temperaturni opseg: -10°C ... +300°C



1,5 mm²
15CR crveni
15CN crni
15PL plavi
 Cena: 1,00

2,5 mm²
25CR crveni
25CN crni
25PL plavi
 Cena: 1,80

KABLOVI
KAB
PROVODNICI KABP
TRAKASTI KABPT
Tehnički podaci:

Primena: Za ostvarivanje unutrašnjih veza u telekomunikacionim, mernim, signalnim i sličnim uređajima
 Konstrukcija: Sastavljeni su od više provodnika tipa TM 70 različitih boja
 Nazivni napon: 220 V
 Ispitni napon: 2000 V
 Temperaturni opseg: -40°C ... +70°C



Tip	Cena	Broj Zila u provodniku (n)	Nazivni presek provodnika (mm ²)	Konstrukcija Zile (mm)	Debljina izolacije (mm)	Maksimalna širina provodnika (mm)	Težina bakra (kg/km)	Ukupna težina (kg/km)
025/10	2,00	10	0,25	7 x 0,20	0,35	13,0	23,0	37,0
025/20	3,00	20	0,25	7 x 0,20	0,35	26,0	46,0	74,0
025/30	5,00	30	0,25	7 x 0,20	0,35	39,0	69,0	111,0
05/10	3,00	10	0,50	16 x 0,20	0,40	17,0	46,0	68,0
05/20	5,00	20	0,50	16 x 0,20	0,40	34,0	92,0	136,0
05/30	8,00	30	0,50	16 x 0,20	0,40	51,0	138,0	204,0

FLET KABPF
Tehnički podaci:

Primena: Za ostvarivanje unutrašnjih veza u telekomunikacionim, mernim, signalnim i sličnim uređajima
 Konstrukcija: Finožična uzica od kalaisane bakarne Zice AWG 28 preseka 0,09 mm² izolacija PVC sive boje
 Raster: 1,27 mm
 Napon: 300 V_{eff}
 Struja: 1 A
 Impedansa: 105 Ω
 Kapacitivnost: 41,3 pF/m
 Temperaturni opseg: -20°C ... +105°C



Tip	Cena	Dimenzije u mm		
		A	B	
10	1,00	10 x 0,09 mm ²	12,70	11,43
14	1,50	14 x 0,09 mm ²	20,32	19,05
16	1,80	16 x 0,09 mm ²	33,02	31,75
20	2,20	20 x 0,09 mm ²	25,40	24,13
26	2,80	26 x 0,09 mm ²	33,02	31,75
34	3,80	34 x 0,09 mm ²	43,18	41,91
40	4,50	40 x 0,09 mm ²	50,80	49,53
50	5,50	50 x 0,09 mm ²	63,50	62,23
60	6,50	60 x 0,09 mm ²	76,20	74,93
64	7,00	64 x 0,09 mm ²	81,28	80,01

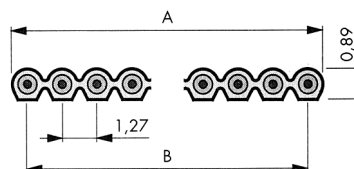

MIKROFONSKI KABLOVI KABMI
Tehnički podaci:

Primena: Za ostvarivanje veza i spojeva kod uređaja za memu i regulacionu tehniku, za elektroakustiku i tonfrekventnu primenu, i kod svih uređaja za prenos govora, tona, slike i brojeva

Konstrukcija: Provodnik od ožarene kalisane bakarne Zice
Izolacija i plašt od PVC mase
Boja siva ili crna

Minimalna otpornost izolacije: 20 MΩ/km

Max. faktor gubitaka: 0,1

Temperaturni opseg: -40°C ... +70°C

MIKROFONSKI KABLOVI – OKRUGLI KABMIO

Dimenzije (mm ²)	Cena	Konstrukcija Zile, broj Zica i prečnik (mm ²)	Prečnik Zila preko izolacije (mm)	Spoljašnji prečnik preko plašta (mm)	Max. otpor provodnika (Ω/km)	Radni napon (V)	Težina provodnika (kg/km)
4 x 0,08	1,20	10 x 0,10	1,40	5,50	<243	500	40,0
1 x 0,14	0,50	18 x 0,10	1,20	2,65	131	250	12,5
2 x 0,14	1,00	18 x 0,10	1,20	3,90	131	250	20,8
3 x 0,14	2,00	18 x 0,10	1,20	4,00	131	250	23,2
4 x 0,14	2,50	18 x 0,10	1,20	4,30	131	250	27,3
6 x 0,14	3,20	18 x 0,10	1,20	4,70	131	250	31,5
8 x 0,14	4,00	8 x 0,14	1,20	5,10	148	350	26,0
10 x 0,14	5,00	10 x 0,14	1,20	5,90	148	350	27,5
12 x 0,14	6,00	12 x 0,14	1,20	6,20	148	350	36,0
15 x 0,14	7,00	15 x 0,14	1,20	6,50	148	350	42,0
25 x 0,14	10,00	25 x 0,14	1,20	8,60	148	350	81,3
37 x 0,14	15,00	37 x 0,14	1,20	9,60	148	350	117,3
1 x 0,25	0,50	14 x 0,15	1,40	2,85	75	350	14,2
2 x 0,25	1,30	14 x 0,15	1,40	4,20	75	350	24,6
3 x 0,25	2,00	14 x 0,15	1,40	4,50	75	350	29,8
4 x 0,25	2,50	14 x 0,15	1,40	4,80	75	350	34,8
5 x 0,25	3,00	14 x 0,15	1,40	5,20	75	350	40,9
1 x 0,5	0,80	16 x 0,20	1,95	3,35	37	350	20,5
2 x 0,5	2,20	16 x 0,20	1,95	5,30	37	350	35,8
3 x 0,5	2,50	16 x 0,20	1,95	5,60	37	350	44,1
4 x 0,5	3,00	16 x 0,20	1,95	6,30	37	350	63,3
5 x 0,5	4,00	16 x 0,20	1,95	6,90	37	350	73,4

KABLOVI
KAB
MIKROFONSKI KABLOVI KABMI
MIKROFONSKI KABLOVI – TRAKASTI KABMIT

Dimenzije (mm ²)	Cena	Konstrukcija Zile, broj Zica i prečnik (mm)	Prečnik preko izolacije (mm)	Zila preko izolacije (mm)	Spoljašnji prečnik preko plašta (mm)	Max. otpor provodnika (Ω/km)	Radni napon (V)	TeZina provodnika (kg/km)
2 x 0,08	0,60	18 x 0,10	1,20	3,90	131	250	20,80	
4 x 0,08	1,20	18 x 0,10	1,20	3,90	131	250	41,60	

MIKROFONSKI KABLOVI – COLOR KABMIC
Tehnički podaci

Kapacitet: 160 pF/m
 Otpor izolacije: 90 Ω/km
 Provodnik: 2 x 28 x 0,10

Tip	Boja
CR	crveni
CN	crni
ZU	Zuti
ZE	zeleni
PL	plavi

Cena: 2,00

ANTENSKI – KOAKSIJALNI KABLOVI KABAN
Tehnički podaci:

Tip: RG / U
 Primena: Za telekomunikacije, radio i televizijsku tehniku, radarske i navigacione uređaje, kod avionskih i brodskih instalacija itd.
 Konstrukcija: Provodnik je finožično uže od kalaisane bakarne Zice, posrebrene bakarne Zice ili od pune posrebrene bakarne Zice
 Izolacija je od bešavnog sloja polietilena ili od teflona
 Plašt je od bešavnog sloja PVC mase ili od polietilena
 Omotač je od bešavnog sloja PVC mase crne ili bele boje
 Temperaturni opseg: -55°C ... +85°C



Tip	Cena	Unutrašnji provodnik (mm)	Prečnik izolacije (mm)	Prečnik spolj. pr. max. (mm)	Prečnik kabla (mm)	Karakter. impedansa (Ω)	Kapacitet (pF/m)	Radni napon (kVss)	TeZina kabla (kg/km)
RG58	0,90	19 x 0,18	2,95	3,5	5,0	50±2	102	2	39
RG59	0,60	φ1,0	4,8	5,9	7,0	75±3	56	1,2	50
RG179	1,20	7 x 0,10	1,6	2,1	2,54	75±5	67	1,2	38
RG213	3,00	7 x 0,76	7,25	8,2	10,3	50±2	101	5	157

AUDIO-VIDEO KABLOVI. KABAV**ČINČ MUŠKI – ČINČ MUŠKI**

Tip	Duzina (m)	Cena
00M	1,5	1,00

**ČINČ ZENSKI – ČINČ ZENSKI**

Tip	Duzina (m)	Cena
00Z	1,5	1,00

**2 x ČINČ MUŠKI – 2 x ČINČ MUŠKI**





Tip	Duzina (m)	Cena
01	1,5	2,00
01/3	3,0	3,00
01/5	5,0	5,00
01/10	10	8,00

**2 x ČINČ MUŠKI – 2 x ČINČ MUŠKI (POZLAČENI)**

Tip	Duzina (m)	Cena
01P	1,5	3,00
01P/2	2,5	4,00
01P/5	5,0	6,00



AUDIO-VIDEO KABLOVI. KABAV

<p>2 x ČINČ MUŠKI – 2 x ČINČ MUŠKI (ZLATNI)+ OFC</p>			
<p>Tip Duzina (m) Cena</p> <p>01Z 1,5 18,00</p>			
<p>2 x ČINČ MUŠKI – 2 x ČINČ MUŠKI + 2 x UTIČNICE</p>			
<p>Tip Duzina (m) Cena</p> <p>01U 1,5 4,00</p>			
<p>2 x ČINČ MUŠKI – 2 x ČINČ ZENSKI</p>			
<p>Tip Duzina (m) Cena</p> <p>02 1,5 2,00</p>			
<p>02/2 2,5 3,00</p>			
<p>02/5 5,0 5,00</p>			
<p>02/10 10 8,00</p>			
<p>4 x ČINČ MUŠKI – 4 x ČINČ MUŠKI</p>			
<p>Tip Duzina (m) Cena</p> <p>03 1,5 5,00</p>			
<p>03/2 2,5 7,00</p>			
<p>4 x ČINČ MUŠKI – 4 x ČINČ ZENSKI</p>			
<p>Tip Duzina (m) Cena</p> <p>04 1,5 5,00</p>			

AUDIO-VIDEO KABLOVI. KABAV**UTIKAČ DIN 5 – UTIKAČ DIN 5**

Tip	Duzina (m)	Cena
05	1,5	4,00
05/5	5,0	7,00

**UTIKAČ DIN 5 – UTIČNICA DIN 5**

Tip	Duzina (m)	Cena
06	1,5	5,00

**UTIČNICA DIN 5 – 4 x ČINČ MUŠKI**

Tip	Duzina (m)	Cena
07	0,2	4,00

**UTIKAČ DIN 5 – 4 x ČINČ MUŠKI**

Tip	Duzina (m)	Cena
08	1,5	5,00

**UTIKAČ DIN 5 – 4 x ČINČ ZENSKI**

Tip	Duzina (m)	Cena
09	0,2	3,00



AUDIO-VIDEO KABLOVI. KABAV

UTIKAČ SCART MUŠKI – UTIKAČ SCART ZENSKI (21 PIN)

Tip	Duzina (m)	Cena
10	2,5	12,00
10/5	5,0	20,00



UTIKAČ SCART – UTIKAČ SCART

Tip	Duzina (m)	Cena	Opis
11	1,5	6,00	9 pin
11/21	1,5	9,00	21 pin
11-21/2	2,0	12,00	21 pin
11-21/5	5,0	20,00	21 pin
11-21/10	10	32,00	21 pin



UTIČNICA SCART – UTIČNICA SCART

Tip	Duzina (m)	Cena
12	0,5	9,00

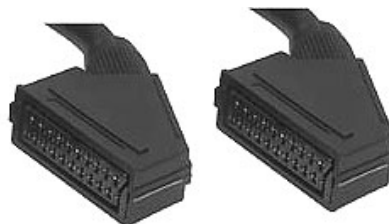

UTIKAČ SCART – 4 x ČINČ MUŠKI

Tip	Duzina (m)	Cena
13	1,5	6,00



UTIKAČ SCART – 6 x ČINČ MUŠKI

Tip	Duzina (m)	Cena
14	1,2	9,00



AUDIO-VIDEO KABLOVI. KABAV**3 x ČINČ MUŠKI – 3 x ČINČ MUŠKI**

Tip	Duzina (m)	Cena
15	1,5	3,00
15/5	5,0	7,00
15/10	10	10,00

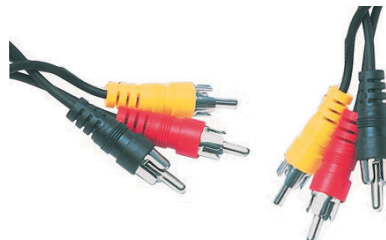
**UTIKAČ 3,5 STEREO – 2 x ČINČ MUŠKI**

Tip	Duzina (m)	Cena
16	1,5	2,00
16/02	0,2	1,50
16/2	2,5	3,00
16/5	5,0	5,00
16/10	10	8,00
16/15	15	12,00
16/20	20	15,00

**UTIKAČ 3,5 STEREO – UTIKAČ 3,5 STEREO**

Tip	Duzina (m)	Cena
17	1,5	2,50
17/5	5,0	5,00
17/10	10	8,00

**UTIKAČ 3,5 MONO – UTIKAČ 3,5 MONO**

Tip	Duzina (m)	Cena
18	1,2	2,00

**UTIKAČ 2,5 STEREO – UTIKAČ 2,5 STEREO**

Tip	Duzina (m)	Cena
19	1,2	3,00



AUDIO-VIDEO KABLOVI. KABAV

<p>SPIRALNI KABLI 2 x 6,3 UTIKAČ MONO</p> <table border="1"> <thead> <tr> <th>Tip</th> <th>Duzina (m)</th> <th>Cena</th> </tr> </thead> <tbody> <tr> <td>20</td> <td>1,5</td> <td>8,00</td> </tr> </tbody> </table>	Tip	Duzina (m)	Cena	20	1,5	8,00	
Tip	Duzina (m)	Cena					
20	1,5	8,00					
<p>PRODUZNI KABLI 3,5 STEREO</p> <table border="1"> <thead> <tr> <th>Tip</th> <th>Duzina (m)</th> <th>Cena</th> </tr> </thead> <tbody> <tr> <td>21</td> <td>3,0</td> <td>5,00</td> </tr> </tbody> </table>	Tip	Duzina (m)	Cena	21	3,0	5,00	
Tip	Duzina (m)	Cena					
21	3,0	5,00					
<p>PRODUZNI KABLI 6,3 STEREO</p> <table border="1"> <thead> <tr> <th>Tip</th> <th>Duzina (m)</th> <th>Cena</th> </tr> </thead> <tbody> <tr> <td>22</td> <td>5,0</td> <td>9,00</td> </tr> </tbody> </table>	Tip	Duzina (m)	Cena	22	5,0	9,00	
Tip	Duzina (m)	Cena					
22	5,0	9,00					
<p>UTIKAČ DIN 5 – 2 x UTIKAČ 3,5 MONO</p> <table border="1"> <thead> <tr> <th>Tip</th> <th>Duzina (m)</th> <th>Cena</th> </tr> </thead> <tbody> <tr> <td>23</td> <td>1,5</td> <td>3,00</td> </tr> </tbody> </table>	Tip	Duzina (m)	Cena	23	1,5	3,00	
Tip	Duzina (m)	Cena					
23	1,5	3,00					
<p>UTIKAČ DIN 5 – UTIKAČ 3,5 STEREO</p> <table border="1"> <thead> <tr> <th>Tip</th> <th>Duzina (m)</th> <th>Cena</th> </tr> </thead> <tbody> <tr> <td>24</td> <td>1,5</td> <td>3,00</td> </tr> </tbody> </table>	Tip	Duzina (m)	Cena	24	1,5	3,00	
Tip	Duzina (m)	Cena					
24	1,5	3,00					

AUDIO-VIDEO KABLOVI. KABAV

UTIKAČ DIN 5 – UTIČNICA 6,3 STEREO

Tip	Duzina (m)	Cena
25A	0,2	3,00
25B	0,2	3,00

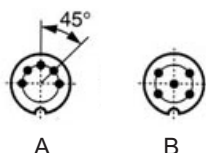

UTIČNICA DIN 5 – UTIKAČ 6,3 STEREO

Tip	Duzina (m)	Cena
26A	0,2	3,00
26B	0,2	3,00

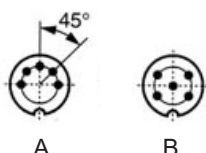

UTIKAČ DIN 6 – UTIKAČ DIN 6

Tip	Duzina (m)	Cena
27	2,0	5,00



UTIKAČ DIN 6 – UTIČNICA DIN 6

Tip	Duzina (m)	Cena
28	2,0	12,00



UTIKAČ BNC – UTIKAČ BNC

Tip	Duzina (m)	Cena
29	1,5	7,00



AUDIO-VIDEO KABLOVI. KABAV

<p>UTIKAČ MDIN 5 – UTIKAČ MDIN 5</p>																	
<table border="1"> <thead> <tr> <th>Tip</th> <th>Duzina (m)</th> <th>Cena</th> </tr> </thead> <tbody> <tr> <td>30</td> <td>1,5</td> <td>5,00</td> </tr> </tbody> </table>	Tip	Duzina (m)		Cena	30	1,5	5,00										
Tip	Duzina (m)	Cena															
30	1,5	5,00															
<p>UTIKAČ MDIN 5 – UTIKAČ 2,5 STEREO</p>																	
<table border="1"> <thead> <tr> <th>Tip</th> <th>Duzina (m)</th> <th>Cena</th> </tr> </thead> <tbody> <tr> <td>31</td> <td>1,5</td> <td>5,00</td> </tr> </tbody> </table>	Tip	Duzina (m)		Cena	31	1,5	5,00										
Tip	Duzina (m)	Cena															
31	1,5	5,00															
<p>SVHS UTIKAČ - SVHS UTIKAČ</p>																	
<table border="1"> <thead> <tr> <th>Tip</th> <th>Duzina (m)</th> <th>Cena</th> </tr> </thead> <tbody> <tr> <td>32</td> <td>1,5</td> <td>6,00</td> </tr> <tr> <td>32/2</td> <td>2,5</td> <td>8,00</td> </tr> <tr> <td>32/5</td> <td>5,0</td> <td>10,00</td> </tr> <tr> <td>32/10</td> <td>10</td> <td>14,00</td> </tr> </tbody> </table>	Tip	Duzina (m)		Cena	32	1,5	6,00	32/2	2,5	8,00	32/5	5,0	10,00	32/10	10	14,00	
Tip	Duzina (m)	Cena															
32	1,5	6,00															
32/2	2,5	8,00															
32/5	5,0	10,00															
32/10	10	14,00															
<p>SVHS UTIKAČ – SVHS UTIČNICA</p>																	
<table border="1"> <thead> <tr> <th>Tip</th> <th>Duzina (m)</th> <th>Cena</th> </tr> </thead> <tbody> <tr> <td>33</td> <td>1,5</td> <td>6,00</td> </tr> <tr> <td>33/2</td> <td>2,5</td> <td>8,00</td> </tr> <tr> <td>33/5</td> <td>5,0</td> <td>10,00</td> </tr> <tr> <td>33/10</td> <td>10</td> <td>14,00</td> </tr> </tbody> </table>	Tip	Duzina (m)	Cena	33	1,5	6,00	33/2	2,5	8,00	33/5	5,0	10,00	33/10	10	14,00		
Tip	Duzina (m)	Cena															
33	1,5	6,00															
33/2	2,5	8,00															
33/5	5,0	10,00															
33/10	10	14,00															
<p>SVHS UTIKAČ – UTIKAČ SCART</p>																	
<table border="1"> <thead> <tr> <th>Tip</th> <th>Duzina (m)</th> <th>Cena</th> </tr> </thead> <tbody> <tr> <td>34</td> <td>1,5</td> <td>7,00</td> </tr> </tbody> </table>	Tip	Duzina (m)	Cena	34	1,5	7,00											
Tip	Duzina (m)	Cena															
34	1,5	7,00															

AUDIO-VIDEO KABLOVI. KABAV**UTIKAČ CAMCORDER 8 – UTIKAČ CAMCORDER 8**

Tip	Duzina (m)	Cena
35	1,5	7,00

**UTIKAČ CAMCORDER 8 – 2 x ČINČ MUŠKI**

Tip	Duzina (m)	Cena
36	2,0	6,00

**UTIKAČ CAMCORDER 8 – 3 x ČINČ MUŠKI**

Tip	Duzina (m)	Cena
37	2,0	7,00

**UTIKAČ CAMCORDER 8 – UTIKAČ SCART**

Tip	Duzina (m)	Cena
38/1	1,5	7,00
38/3	3,0	9,00

**UTIKAČ CAMCORDER, UTIKAČ SVHS – UTIKAČ SCART**

Tip	Duzina (m)	Cena
39	1,5	12,00



AUDIO-VIDEO KABLOVI. KABAV

<p>UTIKAČ CAMCORDER 8 – UTIKAČ DIN 6 + UTIKAČ 3,5 STEREO</p> <table border="1"> <thead> <tr> <th>Tip</th> <th>Duzina (m)</th> <th>Cena</th> </tr> </thead> <tbody> <tr> <td>40</td> <td>1,5</td> <td>9,00</td> </tr> </tbody> </table>	Tip	Duzina (m)	Cena	40	1,5	9,00	
Tip	Duzina (m)	Cena					
40	1,5	9,00					
<p>UTIKAČ CAMCORDER 8 – UTIKAČ DIN 6</p> <table border="1"> <thead> <tr> <th>Tip</th> <th>Duzina (m)</th> <th>Cena</th> </tr> </thead> <tbody> <tr> <td>41</td> <td>3,0</td> <td>8,00</td> </tr> </tbody> </table>	Tip	Duzina (m)	Cena	41	3,0	8,00	
Tip	Duzina (m)	Cena					
41	3,0	8,00					
<p>UTIKAČ DIN 6 – 3 x ČINČ MUŠKI</p> <table border="1"> <thead> <tr> <th>Tip</th> <th>Duzina (m)</th> <th>Cena</th> </tr> </thead> <tbody> <tr> <td>42</td> <td>1,5</td> <td>6,00</td> </tr> </tbody> </table>	Tip	Duzina (m)	Cena	42	1,5	6,00	
Tip	Duzina (m)	Cena					
42	1,5	6,00					
<p>UTIČNICA DIN 6 – UTIKAČ DIN 5 + BNC UTIKAČ</p> <table border="1"> <thead> <tr> <th>Tip</th> <th>Duzina (m)</th> <th>Cena</th> </tr> </thead> <tbody> <tr> <td>43</td> <td>0,2</td> <td>8,00</td> </tr> </tbody> </table>	Tip	Duzina (m)	Cena	43	0,2	8,00	
Tip	Duzina (m)	Cena					
43	0,2	8,00					
<p>KOMPLET KABLOVA</p> <table border="1"> <thead> <tr> <th>Tip</th> <th>Duzina (m)</th> <th>Cena</th> </tr> </thead> <tbody> <tr> <td>44</td> <td>1,5</td> <td>16,00</td> </tr> </tbody> </table>	Tip	Duzina (m)	Cena	44	1,5	16,00	
Tip	Duzina (m)	Cena					
44	1,5	16,00					

AUDIO-VIDEO KABLOVI. KABAV

**UTIKAČ SCART - UTIKAČ DIN 6
 + PREKIDAČ SNIMANJE / REPRODUKCIJA**

Tip	Duzina (m)	Cena
45	1,5	9,00



UTIKAČ SCART – UTIČNICA DIN 6

Tip	Duzina (m)	Cena
46	0,2	5,00



**UTIKAČ SCART - 2 x BNC UTIKAČ
 + UTIKAČ DIN 5 180°**

Tip	Duzina (m)	Cena
47	1,5	16,00



**UTIKAČ SCART - UTIKAČ SCART
 + 2 x ČINČ MUŠKI (AUDIO)**

Tip	Duzina (m)	Cena
48	1,5	14,00



UTIKAČ SCART - SVHS UTIKAČ + 2 x ČINČ MUŠKI (AUDIO)

Tip	Duzina (m)	Cena
49	1,5	9,00



AUDIO-VIDEO KABLOVI. KABAV

UTIKAČ SCART - UTIČNICA SCART+ 2 x ČINČ MUŠKI

Tip	Duzina (m)	Cena
50	0,2	9,00



UTIKAČ SCART – SUBD HD 15 zENSKI

Tip	Duzina (m)	Cena
51	2,0	12,00



UTIKAČ SCART - 2 x UTIČNICA SCART (9 PIN)

Tip	Duzina (m)	Cena
52	0,2	14,00



**UTIKAČ SCART - 2 x ČINČ MUŠKI (AUDIO) + ČINČ MUŠKI (VIDEO)
 + PREKIDAČ SNIMANJE / REPRODUKCIJA**

Tip	Duzina (m)	Cena
53	1,5	9,00



**UTIKAČ SCART - ČINČ MUŠKI (AUDIO) + ČINČ MUŠKI (VIDEO)
 + PREKIDAČ SNIMANJE / REPRODUKCIJA**

Tip	Duzina (m)	Cena
54	1,5	8,00



AUDIO-VIDEO KABLOVI. KABAV**UTIKAČ SCART - UTIKAČ CAMCORDER 8 + UTIKAČ 3,5 MONO**

Tip	Duzina (m)	Cena
55	1,5	12,00

**UTIKAČ SCART – 2 x ČINČ MUŠKI (AUDIO ULAZ)
+ 2 x ČINČ MUŠKI (AUDIO IZLAZ)**

Tip	Duzina (m)	Cena
56	2,0	9,00

**UTIKAČ SCART - UTIKAČ SCART + 4 x ČINČ MUŠKI AUDIO ULAZ / IZLAZ**

Tip	Duzina (m)	Cena
57	1,5	14,00

**UTIKAČ SCART - UTIKAČ SCART (ULAZ) + UTIKAČ SCART (IZLAZ)**

Tip	Duzina (m)	Cena
58	2,0	16,00

**UTIKAČ SCART - UTIČNICA SCART 21 PIN + UTIČNICA 3,5 STEREO**

Tip	Duzina (m)	Cena
59	0,2	9,00



AUDIO-VIDEO KABLOVI. KABAV**ČINČ MUŠKI - 2 x ČINČ zENSKI**

Tip	Duzina (m)	Cena
60	1,5	2,00

**ČINČ MUŠKI - 2 x ČINČ MUŠKI**

Tip	Duzina (m)	Cena
61	1,2	2,00

**ČINČ zENSKI - 2 x ČINČ MUŠKI**

Tip	Duzina (m)	Cena
62	1,5	2,00

**ČINČ MUŠKI - UTIKAČ BNC**

Tip	Duzina (m)	Cena
63	1,5	4,00

**ČINČ zENSKI - UTIKAČ 3,5 MONO**

Tip	Duzina (m)	Cena
64	1,5	1,50



AUDIO-VIDEO KABLOVI. KABAV**2 x ČINČ MUŠKI - UTIKAČ 6,3 STEREO**

Tip	Duzina (m)	Cena
65	1,5	2,50

**2 x ČINČ MUŠKI – UTIČNICA 6,3 STEREO**

Tip	Duzina (m)	Cena
66	1,2	3,00

**UTIKAČ 6,3 STEREO- 2 x UTIČNICA 6,3 STEREO**

Tip	Duzina (m)	Cena
67	1,5	4,00

**UTIKAČ 3,5 MONO - UTIČNICA 3,5 MONO**

Tip	Duzina (m)	Cena
68	1,5	2,00

**2 x ČINČ MUŠKI - 2 x ČINČ MUŠKI**

Tip	Duzina (m)	Cena
69	0,2	2,00



AUDIO-VIDEO KABLOVI. KABAV

<p>2 x ČINČZENSKI - UTIKAČ 3,5 MONO</p> <table border="1"> <thead> <tr> <th>Tip</th> <th>Duzina (m)</th> <th>Cena</th> </tr> </thead> <tbody> <tr> <td>70</td> <td>0,2</td> <td>1,50</td> </tr> </tbody> </table>	Tip	Duzina (m)	Cena	70	0,2	1,50	
Tip	Duzina (m)	Cena					
70	0,2	1,50					
<p>2 x ČINČ ZENSKI – UTIKAČ 3,5 STEREO</p> <table border="1"> <thead> <tr> <th>Tip</th> <th>Duzina (m)</th> <th>Cena</th> </tr> </thead> <tbody> <tr> <td>71</td> <td>0,2</td> <td>1,50</td> </tr> </tbody> </table>	Tip	Duzina (m)	Cena	71	0,2	1,50	
Tip	Duzina (m)	Cena					
71	0,2	1,50					
<p>2 x ČINČ MUŠKI - UTIČNICA 3,5 STEREO</p> <table border="1"> <thead> <tr> <th>Tip</th> <th>Duzina (m)</th> <th>Cena</th> </tr> </thead> <tbody> <tr> <td>72</td> <td>0,2</td> <td>2,00</td> </tr> </tbody> </table>	Tip	Duzina (m)	Cena	72	0,2	2,00	
Tip	Duzina (m)	Cena					
72	0,2	2,00					
<p>UTIKAČ 3,5 STEREO - UTIČNICA 3,5 MONO</p> <table border="1"> <thead> <tr> <th>Tip</th> <th>Duzina (m)</th> <th>Cena</th> </tr> </thead> <tbody> <tr> <td>73</td> <td>0,2</td> <td>2,50</td> </tr> </tbody> </table>	Tip	Duzina (m)	Cena	73	0,2	2,50	
Tip	Duzina (m)	Cena					
73	0,2	2,50					
<p>UTIKAČ 3,5 STEREO - 2 x UTIČNICA 3,5 STEREO</p> <table border="1"> <thead> <tr> <th>Tip</th> <th>Duzina (m)</th> <th>Cena</th> </tr> </thead> <tbody> <tr> <td>74</td> <td>0,2</td> <td>2,50</td> </tr> </tbody> </table>	Tip	Duzina (m)	Cena	74	0,2	2,50	
Tip	Duzina (m)	Cena					
74	0,2	2,50					

AUDIO-VIDEO KABLOVI. KABAV

UTIKAČ 3,5 STEREO - UTIČNICA 6,3 STEREO

Tip	Duzina (m)	Cena
75	0,2	1,50



UTIKAČ 3,5 MONO – UTIČNICA 6,3 MONO

Tip	Duzina (m)	Cena
76	0,2	2,00



UTIKAČ 3,5 MONO - UTIČNICA 6,3 STEREO

Tip	Duzina (m)	Cena
77	0,2	2,00



UTIKAČ 6,3 STEREO - UTIČNICA 3,5 MONO

Tip	Duzina (m)	Cena
78	0,2	1,50



2 x UTIKAČ 6,3 MONO - UTIČNICA 6,3 MONO

Tip	Duzina (m)	Cena
79	0,2	3,00



AUDIO-VIDEO ANTENSKI KABLOVI KABAVA

KOAX. UTIKAČI MUŠKI – ZENSKI (BELI)

Tip	Duzina (m)	Cena
B1	1,5	2,50
B2	2,5	3,50
B5	5,0	5,00
B10	10	9,00



KOAX. UTIKAČI MUŠKI – ZENSKI (CRNI)

Tip	Duzina (m)	Cena
C1	1,5	2,50
C2	2,5	3,50
C5	5,0	5,00
C10	10	9,00



KOAX. UTIKAČI MUŠKI – ZENSKI (UGAONI)

Tip	Duzina (m)	Cena
U1	1,5	3,00
U2	2,5	4,00
U5	5,0	6,00
U10	10	10,00



KOAX. UTIKAČ MUŠKI – F UTIKAČ

Tip	Duzina (m)	Cena
KF1	1,5	3,50
KF3	3,0	5,00



F UTIKAČ – F UTIKAČ

Tip	Duzina (m)	Cena
FF1	1,5	3,00
FF2	2,5	4,00
FF5	5,0	6,00
FF10	10	11,00



AUDIO-VIDEO OPTIČKI KABLOVI. KABA VO

TOSLINK – TOSLINK

Tip	Duzina (m)	Cena
1	1,0	12,00
1/5	5,0	24,00
1/10	10	42,00



TOSLINK – UTIKAČ 3,5 mm

Tip	Duzina (m)	Cena
2	1,0	14,00

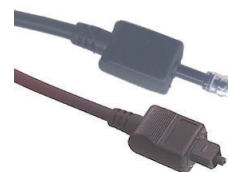

UTIKAČ 3,5 mm – UTIKAČ 3,5 mm

Tip	Duzina (m)	Cena
3	1,0	16,00



AUDIO-VIDEO UNIVERZALNI KABLOVI KABA VU

AUDIO, VIDEO, S-VIDEO, OPTIČKI KABL

RCA ČINČ UTIKAČI 3X2
SVHS - SVHS UTIKAČI
OPTIČKI KABL TOSLINK -TOSLINK

Tip	Duzina (m)	Cena
U	1,5	26,00

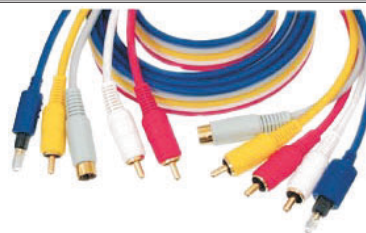

AUDIO - VIDEO KABLOVI ZA CAMCORDER KABA VC

3 x ČINČ MUŠKI - UTIKAČ 3,5 mm (3 PRSTENA)



Tip	Duzina (m)	Cena
P	1,0	12,00



AUDIO-VIDEO DIGITALNI KABLOVI. KABAVD

<p>DIGITALNI KOAKSIJALNI AUDIO KABL RCA ČINČ MUŠKI – RCA ČINČ MUŠKI</p>			
Tip	Duzina (m)	Cena	
A1	1,5	7,00	
A2	2,5	10,00	
A5	5,0	15,00	
<p>DIGITALNI OPTIČKI KABL TOSLINK – TOSLINK</p>			
Tip	Duzina (m)	Cena	
01	1,5	32,00	
02	2,5	38,00	
05	5,0	52,00	
<p>DIGITALNI OPTIČKI KABL 3,5mm / TOSLINK – 3,5 mm / TOSLINK</p>			
Tip	Duzina (m)	Cena	
0	1,0	24,00	

KABLOVI FIREWIRE. KABFW

<p>ZA POVEZIVANJE DVE DV KAMERE</p>			
Tip	Duzina (m)	Cena	
4 x 4	1,5	18,00	
4 x 4/3	3,0	22,00	
4 x 4/5	5,0	24,00	
4 x 4/F	1,5	32,00 sa feritima	
<p>ZA POVEZIVANJE DV KAMERE I RAČUNARA</p>			
Tip	Duzina (m)	Cena	
6 x 4	1,5	18,00	
6 x 4/3	3,0	24,00	
6 x 4/5	5,0	26,00	
<p>ZA POVEZIVANJE DVA RAČUNARA</p>			
Tip	Duzina (m)	Cena	
6 x 6	1,5	18,00	
6 x 6/3	3,0	24,00	

AUDIO VIDEO KABLOVI ZA SONY PLAYSTATION. KABAVS

PLAYSTATION KABLI – 3 x ČINČ MUŠKI

Tip	Duzina (m)	Cena
1	1,0	12,00



PLAYSTATION SCART KABLI – AUDIO VIDEO ČINČ ULAZI

Tip	Duzina (m)	Cena
2	1,8	15,00



PLAYSTATION CONTROLER EXTENSION KABLI

Tip	Duzina (m)	Cena
3	1,8	12,00



PLAYSTATION LINK KABLI

Tip	Duzina (m)	Cena
4	1,8	12,00



PAL RF ADAPTER PSX-PSX2

Tip	Duzina (m)	Cena
5	2,0	28,00



KABLOVI

KAB

DC KABLI - SONY DISCMAN KABDCS

DC KABL SONY DISCMAN

Tip	Duzina (m)	Cena
DC	1,8	5,00



KABLOVI ZA INSTRUMENTE KABIN

01



Cena: 5,00

02

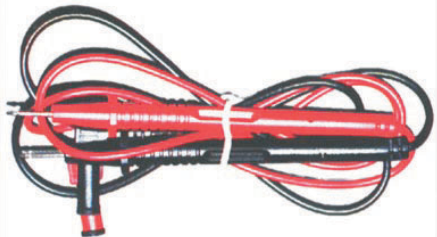

Cena: 8,00

MERNI KABLOVI. KABME

SA BANANA UTIKAČIMA ϕ 4 KABMEB

Tip	Boja
CR	crveni
CN	crni
ZU	zuti
ZE	zeleni
PL	plavi

Cena: 9,00



BNC UTIKAČ – CR / CN ŠTIPALJKE KABMEBNC

Duzina	Cena
1,5	8,00



KABLOVI ZA AUTOMOBILE. KABAU

KABLOVI ZA POVEZIVANJE AUTO KASETOFONA

 BMW 15,00	 FORD 15,00
 HONDA 15,00	 HYUNDAI 15,00
 MAZDA 15,00	 MERCEDES 15,00
 MITSUBISHI 15,00	 NISSAN 15,00
 PEUGEOT 15,00	 SUZUKI 15,00
 TOYOTA 15,00	 UNIVERZALNI 12,00

KABLOVI ZA ZVUČNIKE KABZ
Tehnički podaci:

Primena: Za ostvarivanje spoljašnjih veza između akustičnih uređaja i zvučnika i za ostale primene kod mernih, signalnih i drugih uređaja

Konstrukcija: Provodnik od finožičnog, meko ozarenog, bakarnog uzeta
Izolacija od PVC mase preko paralelno postavljenih provodnika

Temperaturni opseg: -10°C ... +70°C

CRVENO-CRNI KABZ

Tip	Cena	Konstrukcija provodnika broj x preč. zice (mm)	Debljina izolacije (mm)	Maksimalne spoljne mere debljina x širina (mm)
2 x 0,15	0,30	5 x 0,20	0,80	2,0 x 4,0
2 x 0,35	0,40	11 x 0,20	0,80	2,5 x 5,0
2 x 0,50	0,50	16 x 0,20	0,80	3,0 x 6,0
2 x 0,75	0,60	24 x 0,20	0,80	3,2 x 6,4
2 x 1,00	0,80	32 x 0,20	0,80	3,4 x 6,8
2 x 1,50	1,00	48 x 0,20	0,80	4,8 x 7,2

TRANSPARENT KABZT

Tip	Cena	Konstrukcija provodnika broj x preč. zice (mm)	Maksimalne spoljne mere debljina x širina (mm)
2 x 0,5	0,60	64 x 0,10	2,5 x 4,0
2 x 0,75	0,80	95 x 0,10	2,5 x 5,5
2 x 1,0	1,00	127 x 0,10	3,0 x 6,0
2 x 1,5	1,50	189 x 0,10	3,1 x 6,5
2 x 2,5	2,00	322 x 0,10	3,6 x 6,5
2 x 4,0	3,50	511 x 0,10	5,0 x 10,2
2 x 6,0	5,00	777 x 0,10	5,1 x 12,5



KABLOVI
KAB
MREZNI KABLOVI KABMR
Tehnički podaci:

Primena: Za ostvarivanje spoljašnjih veza pod lakšim radnim uslovima za priključke uređaja sa manjom potrošnjom (muzički uređaji, prenosne svetiljke, ventilatori i drugi uređaji za domaćinstvo)

Konstrukcija: Provodnik je od finožičnog bakarnog uzeta izolovan PVC masom
Plašt od bešavne PVC mase

Temperaturni opseg: -10°C ... +70°C







TRAKASTI TIP P/L KABMRP/L

Tip / Broj zila i nazivni presek (mm ²)	Cena	Konstrukcija provodnika broj zica x prečnik (mm)	Debljina izolacije (mm)	Maksimalne spoljne mere debljina x širina (mm)	Tezina bakra (kg/km)	Ukupna tezina (kg/km)
2 x 0,35	0,30	11 x 0,20	0,80	2,5 x 5,0	6,50	13,00
2 x 0,50	0,40	16 x 0,20	0,80	3,0 x 6,0	9,20	21,00
2 x 0,75	0,50	24 x 0,20	0,80	3,2 x 6,4	13,80	27,00
2 x 1,00	0,60	32 x 0,20	0,80	3,4 x 6,8	18,40	32,00
3 x 0,50	0,70	16 x 0,20	0,80	3,0 x 9,0	13,80	32,00
3 x 0,75	0,80	24 x 0,20	0,80	3,2 x 9,6	21,70	41,00
3 x 1,00	0,90	32 x 0,20	0,80	3,4 x 10,2	27,60	48,00

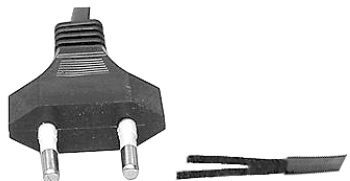
OKRUGLI TIP PP/L KABMRPP/L

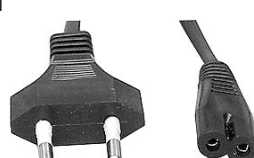
Tip / Broj zila i nazivni presek (mm ²)	Cena	Konstrukcija provodnika broj zica x prečnik (mm)	Debljina izolacije (mm)	Debljina plašta (mm)	Maksimalni spoljni prečnik (mm)	Tezina bakra (kg/km)	Ukupna tezina (kg/km)
2 x 0,50	0,50	16 x 0,20	0,50	0,60	6,0	9,30	44
2 x 0,75	0,70	24 x 0,20	0,50	0,60	6,5	13,90	53
2 x 1,00	0,80	32 x 0,20	0,50	0,60	7,0	18,60	64
3 x 0,50	0,60	16 x 0,20	0,50	0,60	6,4	13,90	53
3 x 0,75	0,90	24 x 0,20	0,50	0,60	6,9	20,90	65
3 x 1,00	1,10	32 x 0,20	0,50	0,60	7,4	27,90	78
4 x 0,50	0,70	16 x 0,20	0,50	0,60	7,0	18,60	64
4 x 0,75	1,00	24 x 0,20	0,50	0,60	7,5	27,90	78
4 x 1,00	1,30	32 x 0,20	0,50	0,60	8,0	37,20	93

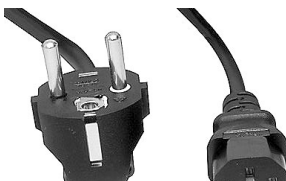
MREZNI KABLOVI KABMR

<p>500</p> <table border="1"> <thead> <tr> <th>Dimenzije</th> <th>Duzina (m)</th> <th>Cena</th> </tr> </thead> <tbody> <tr> <td>2 x 0,75mm</td> <td>2,0</td> <td>2,00</td> </tr> </tbody> </table>	Dimenzije	Duzina (m)	Cena	2 x 0,75mm	2,0	2,00	
Dimenzije	Duzina (m)	Cena					
2 x 0,75mm	2,0	2,00					
<p>600</p> <table border="1"> <thead> <tr> <th>Dimenzije</th> <th>Duzina (m)</th> <th>Cena</th> </tr> </thead> <tbody> <tr> <td>3 x 0,75mm</td> <td>2,0</td> <td>3,00</td> </tr> </tbody> </table>	Dimenzije	Duzina (m)	Cena	3 x 0,75mm	2,0	3,00	
Dimenzije	Duzina (m)	Cena					
3 x 0,75mm	2,0	3,00					
<p>701</p> 	<p>702</p> <table border="1"> <thead> <tr> <th>Dimenzije</th> <th>Duzina (m)</th> <th>Cena</th> </tr> </thead> <tbody> <tr> <td>2 x 0,75mm</td> <td>2</td> <td>2,50</td> </tr> </tbody> </table> 	Dimenzije	Duzina (m)	Cena	2 x 0,75mm	2	2,50
Dimenzije	Duzina (m)	Cena					
2 x 0,75mm	2	2,50					
<p>652/671</p> <table border="1"> <thead> <tr> <th>Dimenzije</th> <th>Duzina (m)</th> <th>Cena</th> </tr> </thead> <tbody> <tr> <td>3 x 0,75mm</td> <td>2,0</td> <td>6,00</td> </tr> </tbody> </table>	Dimenzije	Duzina (m)	Cena	3 x 0,75mm	2,0	6,00	
Dimenzije	Duzina (m)	Cena					
3 x 0,75mm	2,0	6,00					
<p>652/681</p> <table border="1"> <thead> <tr> <th>Dimenzije</th> <th>Duzina (m)</th> <th>Cena</th> </tr> </thead> <tbody> <tr> <td>3 x 0,75mm</td> <td>2,0</td> <td>7,00</td> </tr> </tbody> </table>	Dimenzije	Duzina (m)	Cena	3 x 0,75mm	2,0	7,00	
Dimenzije	Duzina (m)	Cena					
3 x 0,75mm	2,0	7,00					
<p>712</p> <table border="1"> <thead> <tr> <th>Dimenzije</th> <th>Duzina (m)</th> <th>Cena</th> </tr> </thead> <tbody> <tr> <td>3 x 0,75mm</td> <td>1,8</td> <td>9,00</td> </tr> </tbody> </table>	Dimenzije	Duzina (m)	Cena	3 x 0,75mm	1,8	9,00	
Dimenzije	Duzina (m)	Cena					
3 x 0,75mm	1,8	9,00					

KABLOVI ZA KOMPJUTERE KABKO

Tehnički podaci:

Primena: Za ostvarivanje spoljašnjih veza za preno spodatak u kompjuterskoj tehnici i za ostale primene kod mernih signalnih i drugih uređaja

Konstrukcija: Provodnik od bakarne zice
Izolacija od bešavnog sloja polietilena ili od teflona
Plast je od bešavnog sloja PVC mase ili od polietilena
Omotač je od bešavnog sloja PVC mase crne ili bele boje

Nazivni napon: 350 V
Ispitni napon: 1200 V
Otpor izolacije: 100 MΩ x km
Temperaturni opseg: -20°C ... +70°C

Tip	Cena	Spoljni prečnik (mm)
2 x 0,14	0,80	3,0
4 x 0,14	1,60	3,7
6 x 0,14	2,20	4,4
8 x 0,14	2,60	4,7
10 x 0,14	3,00	5,4
12 x 0,14	3,50	5,7
15 x 0,14	4,00	6,0
25 x 0,14	6,00	8,1
37 x 0,14	10,00	9,6



UTP KABLI

Tip	Dimenzije (mm ²)	Otpornost	Cena
4 x 2 x AWG 24	0,205	100Ω	1,30



ISDN KABLOVI SA UTIKAČIMA RJ 45

Tip	Duzina (m)	Cena
01	1	6,00
02	2	7,00
03	3	8,00
05	5	10,00
10	10	17,00

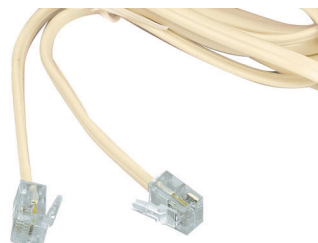



KABLOVI

KAB

KABLOVI ZA KOMPJUTERE KABKO

KABLOVI ZA ŠTAMPAČE

<p>KABLOVI ZA ŠTAMPAČ – PARALELNI SUBD 25 MUŠKI – CENTRONICS 36 MUŠKI</p> <table border="1"> <thead> <tr> <th>Tip</th> <th>Duzina (m)</th> <th>Cena</th> </tr> </thead> <tbody> <tr> <td>110</td> <td>1,5</td> <td>8,00</td> </tr> <tr> <td>111</td> <td>3,0</td> <td>10,00</td> </tr> <tr> <td>112</td> <td>5,0</td> <td>14,00</td> </tr> <tr> <td>113</td> <td>7,5</td> <td>18,00</td> </tr> <tr> <td>114</td> <td>10</td> <td>22,00</td> </tr> <tr> <td>115</td> <td>15</td> <td>32,00</td> </tr> </tbody> </table>			Tip	Duzina (m)	Cena	110	1,5	8,00	111	3,0	10,00	112	5,0	14,00	113	7,5	18,00	114	10	22,00	115	15	32,00										
Tip	Duzina (m)	Cena																															
110	1,5	8,00																															
111	3,0	10,00																															
112	5,0	14,00																															
113	7,5	18,00																															
114	10	22,00																															
115	15	32,00																															
<p>KABLOVI ZA ŠTAMPAČ – PARALELNI SUBD 25 MUŠKI – MINI CENTRONICS 36 MUŠKI</p> <table border="1"> <thead> <tr> <th>Tip</th> <th>Duzina (m)</th> <th>Cena</th> </tr> </thead> <tbody> <tr> <td>110M</td> <td>1,8</td> <td>19,00</td> </tr> <tr> <td>111M</td> <td>3,0</td> <td>24,00</td> </tr> <tr> <td>112M</td> <td>5,0</td> <td>32,00</td> </tr> </tbody> </table>			Tip	Duzina (m)	Cena	110M	1,8	19,00	111M	3,0	24,00	112M	5,0	32,00																			
Tip	Duzina (m)	Cena																															
110M	1,8	19,00																															
111M	3,0	24,00																															
112M	5,0	32,00																															
<p>KABLOVI ZA ŠTAMPAČ – SERIJSKI SUBD 25 MUŠKI – SUBD 9 ZENSKI</p> <table border="1"> <thead> <tr> <th>Tip</th> <th>Duzina (m)</th> <th>Cena</th> </tr> </thead> <tbody> <tr> <td>120</td> <td>1,8</td> <td>6,00</td> </tr> <tr> <td>121</td> <td>3,0</td> <td>8,00</td> </tr> </tbody> </table>			Tip	Duzina (m)	Cena	120	1,8	6,00	121	3,0	8,00	<table border="1"> <thead> <tr> <th colspan="2">Raspored veza</th> </tr> <tr> <th>SUB D 9</th> <th>SUB D 25</th> </tr> </thead> <tbody> <tr> <td>1</td> <td>1</td> </tr> <tr> <td>2</td> <td>3</td> </tr> <tr> <td>3</td> <td>2</td> </tr> <tr> <td>4</td> <td>5</td> </tr> <tr> <td>5</td> <td>4</td> </tr> <tr> <td>6+8</td> <td>20</td> </tr> <tr> <td>7</td> <td>7</td> </tr> <tr> <td>20</td> <td>6+8</td> </tr> </tbody> </table>	Raspored veza		SUB D 9	SUB D 25	1	1	2	3	3	2	4	5	5	4	6+8	20	7	7	20	6+8	
Tip	Duzina (m)	Cena																															
120	1,8	6,00																															
121	3,0	8,00																															
Raspored veza																																	
SUB D 9	SUB D 25																																
1	1																																
2	3																																
3	2																																
4	5																																
5	4																																
6+8	20																																
7	7																																
20	6+8																																

CENTRONICS KABLOVI

<p>CENTRONICS 36 MUŠKI – CENTRONICS 36 MUŠKI</p> <table border="1"> <thead> <tr> <th>Tip</th> <th>Duzina (m)</th> <th>Cena</th> </tr> </thead> <tbody> <tr> <td>108</td> <td>1,5</td> <td>12,00</td> </tr> </tbody> </table>			Tip	Duzina (m)	Cena	108	1,5	12,00	
Tip	Duzina (m)	Cena							
108	1,5	12,00							
<p>CENTRONICS 36 ZENSKI – CENTRONICS 36 ZENSKI</p> <table border="1"> <thead> <tr> <th>Tip</th> <th>Duzina (m)</th> <th>Cena</th> </tr> </thead> <tbody> <tr> <td>108 FF</td> <td>1,5</td> <td>12,00</td> </tr> </tbody> </table>			Tip	Duzina (m)	Cena	108 FF	1,5	12,00	
Tip	Duzina (m)	Cena							
108 FF	1,5	12,00							

DATA KABLOVI

**RS 232 EXTENSION KABL 1:1
 SUBD 25 ZENSKI – SUBD 25 ZENSKI**

Tip	Duzina (m)	Cena
101	1,8	8,00
101/5	5,0	14,00
101/10	10	22,00



**EXTENSION KABL 1:1
 SUBD 25 MUŠKI – SUBD 25 ZENSKI**

Tip	Duzina (m)	Cena
102	1,8	8,00
102/3	3,0	10,00
102/5	5,0	14,00
102/10	10	22,00

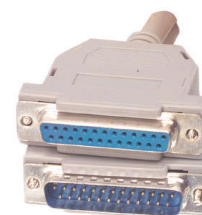

**EXTENSION KABL 1:1
 SUBD 25 MUŠKI – SUBD 25 MUŠKI**

Tip	Duzina (m)	Cena
103	1,8	8,00
103/3	3,0	10,00
103/5	5,0	14,00
103/10	10	22,00



**UNIVERZALNI KABL
 SUBD 25 MUŠKI – SUBD 25 ZENSKI / SUBD 9 ZENSKI**

Tip	Duzina (m)	Cena
104	1,8	12,00



DATA KABLOVI

**NUL MODEM KABL
SUBD 25 ZENSKI – SUBD 9 ZENSKI**

Tip	Duzina (m)	Cena
122	1,8	7,00

Raspored veza
SUB D 9 SUB D 25

1	4
2	2
3	3
4	5/6
5	7
6/8	20
7	8
9	22

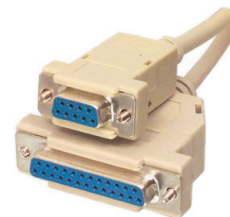

SUBD 9 ZENSKI – SUBD 9 ZENSKI

Tip	Duzina (m)	Cena
123	1,8	7,00
124	3,0	8,00



**PARALEL LAPLINK KABL 1:1
SUBD 25 MUŠKI – SUBD 25 MUŠKI**

Tip	Duzina (m)	Cena
125	1,8	8,00
125/3	3,0	11,00
125/5	5,0	14,00

Raspored veza
SUB D 25 SUB D 25

2	15
3	13
4	12
5	10
6	11
10	5
11	6
12	4
13	3
15	2
25	2

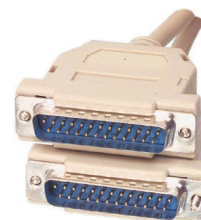



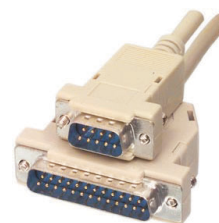

**ADAPTER KABL
SUBD 25 MUŠKI – SUBD 9 MUŠKI**

Tip	Duzina (m)	Cena
126	1,8	6,00

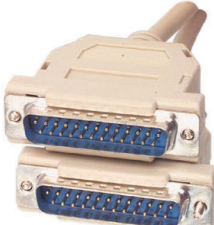

DATA KABLOVI

<p>RS 232 EXTENSION KABL 1:1 SUBD 25 MUŠKI – SUBD 25 MUŠKI</p>					
<p>SUBD 25 muški – SUBD 25 muški</p>					
			<p>1 1 2 3 3 2 4 5 5 4 6+8 20 7 7 20 6+8</p>		
Tip	Duzina (m)	Cena			
127	1,5	7,00			
<p>EXTENSION KABL 1:1 SUBD 25 ZENSKI – SUBD 25 ZENSKI</p>					
<p>SUBD 25 zenski – SUBD 25 zenski</p>					
			<p>2 3 3 2 4 5 5 4 6 20 7 7 20 6</p>		
Tip	Duzina (m)	Cena			
128	1,5	7,00			
<p>INTERLINK KABL 2 X (SUBD 9 ZENSKI – SUBD 25 ZENSKI)</p>					
<p>SUBD9 SUBD 25 SUBD 25 SUBD 9</p>					
			<p>2 3 2 3 3 2 3 2 7 4 5 8 8 5 4 7 5 6 7 5 6 7 20 4 4 20 6 6</p>		
Tip	Duzina (m)	Cena			
129	1,5	7,00			
<p>PC - PC NULL MODEM KABL SUBD 25 ZENSKI - SUBD 25 ZENSKI</p>					
Tip	Duzina (m)	Cena			
136	1,8	6,00			
136/5	5,0	9,00			

KABLOVI ZA KOMPJUTERE KABKO**DATA KABLOVI****SERIJSKI KABL PC PLOTER
SUBD 25 MUŠKI – SUBD 25 ZENSKI**

Tip	Duzina (m)	Cena
137	1,8	7,00
137/5	5,0	10,00

**SERIJSKI NULL MODEM KABL
SUBD 9 ZENSKI – SUBD 9 ZENSKI**

Tip	Duzina (m)	Cena
138	1,8	6,00
138/5	5,0	9,00

**SERIJSKI KABL 1:1
SUBD 9 MUŠKI – SUBD 9 MUŠKI**

Tip	Duzina (m)	Cena
150	1,8	6,00
150/3	3,0	8,00
150/5	5,0	10,00
150/10	10	16,00

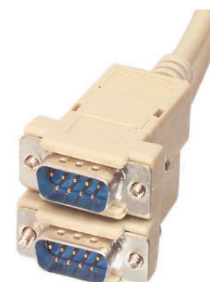
**EXTENSION KABL 1:1
SUBD 9 MUŠKI - SUBD 9 ZENSKI**

Tip	Duzina (m)	Cena
151	1,8	6,00
152	3,0	7,00



KABLOVI ZA KOMPJUTERE KABKO**KABLOVI ZA TASTATURE****DIN 5 MUŠKI – DIN 5 ZENSKI**

Tip	Duzina (m)	Cena
130	1,8	6,00
131	3,0	8,00
131/5	5,0	10,00

**PS2 MINI DIN 6 MUŠKI – MINI DIN 6 ZENSKI**

Tip	Duzina (m)	Cena
132	1,8	6,00
132/3	3,0	8,00
132/5	5,0	10,00

**DIN 5 MUŠKI – DIN 5 MUŠKI**

Tip	Duzina (m)	Cena
133	1,8	6,00
133/3	3,0	8,00
133/5	5,0	10,00

**PS2 MINI DIN 6 MUŠKI – MINI DIN 6 MUŠKI**

Tip	Duzina (m)	Cena
134	1,8	6,00
134/3	5,0	9,00

**DIN 5 ZENSKI – PS2 MINI DIN 6 MUŠKI**

Tip	Duzina (m)	Cena
135	0,1	3,00



**PS2 MINI DIN 6 MUŠKI – 2 X PS2 MINI DIN 6 MUŠKI**

Tip	Duzina (m)	Cena
139	0,2	5,00

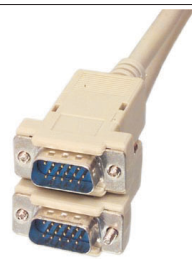

KABLOVI ZA KOMPJUTERE KABKO

KABLOVI ZA MONITORE

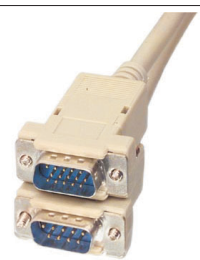
<p>SUBD HD 15 MUŠKI – SUBD HD 15 zENSKI</p>											
<table border="1"> <thead> <tr> <th>Tip</th> <th>Duzina (m)</th> <th>Cena</th> </tr> </thead> <tbody> <tr> <td>170</td> <td>1,8</td> <td>7,00</td> </tr> <tr> <td>171</td> <td>3,0</td> <td>9,00</td> </tr> </tbody> </table>	Tip	Duzina (m)		Cena	170	1,8	7,00	171	3,0	9,00	
Tip	Duzina (m)	Cena									
170	1,8	7,00									
171	3,0	9,00									
<p>SUBD HD 15 MUŠKI – SUBD HD 15 MUŠKI</p>											
<table border="1"> <thead> <tr> <th>Tip</th> <th>Duzina (m)</th> <th>Cena</th> </tr> </thead> <tbody> <tr> <td>172</td> <td>1,8</td> <td>7,00</td> </tr> <tr> <td>173</td> <td>3,0</td> <td>9,00</td> </tr> </tbody> </table>	Tip	Duzina (m)		Cena	172	1,8	7,00	173	3,0	9,00	
Tip	Duzina (m)	Cena									
172	1,8	7,00									
173	3,0	9,00									
<p>SUBD HD 15 MUŠKI – 5 X BNC</p>											
<table border="1"> <thead> <tr> <th>Tip</th> <th>Duzina (m)</th> <th>Cena</th> </tr> </thead> <tbody> <tr> <td>174</td> <td>1,8</td> <td>32,00</td> </tr> <tr> <td>174/4</td> <td>3,0</td> <td>42,00</td> </tr> </tbody> </table>	Tip	Duzina (m)		Cena	174	1,8	32,00	174/4	3,0	42,00	
Tip	Duzina (m)	Cena									
174	1,8	32,00									
174/4	3,0	42,00									
<p>SUBD 15 MUŠKI – SUBD HD 15 zENSKI</p>											
<table border="1"> <thead> <tr> <th>Tip</th> <th>Duzina (m)</th> <th>Cena</th> </tr> </thead> <tbody> <tr> <td>175</td> <td>1,8</td> <td>7,00</td> </tr> </tbody> </table>	Tip	Duzina (m)		Cena	175	1,8	7,00				
Tip	Duzina (m)	Cena									
175	1,8	7,00									
<p>SUBD 9 MUŠKI – SUBD HD 15 MUŠKI</p>											
<table border="1"> <thead> <tr> <th>Tip</th> <th>Duzina (m)</th> <th>Cena</th> </tr> </thead> <tbody> <tr> <td>176</td> <td>1,8</td> <td>7,00</td> </tr> </tbody> </table>	Tip	Duzina (m)		Cena	176	1,8	7,00				
Tip	Duzina (m)	Cena									
176	1,8	7,00									

KABLOVI ZA KOMPJUTERE KABKO**KABLOVI ZA MONITORE****DUPLO ŠIRMOVANI KABL SA FERITIMA
SUBD HD 15 MUŠKI - SUBD HD 15 MUŠKI**

Tip	Duzina (m)	Cena
177	1,8	15,00
177/3	3,0	18,00
177/5	5,0	26,00

**DUPLO ŠIRMOVANI KABL SA FERITIMA
SUBD HD 15 MUŠKI - SUBD HD 15 ZENSKI**

Tip	Duzina (m)	Cena
178	1,8	15,00
178/3	3,0	18,00
178/5	5,0	26,00

**DFP/LCD KABL SA FERITIMA ZA LCD MONITORE
HPC 20 MUŠKI – HPC 20 MUŠKI**

Tip	Duzina (m)	Cena
190	1,8	38,00





**DFP/LCD KABL SA FERITIMA ZA LCD MONITORE
HPC 26 MUŠKI – HPC 26 MUŠKI**

Tip	Duzina (m)	Cena
191	1,8	42,00



KABLOVI ZA KOMJUTERE KABKO

KABLOVI ZA MONITORE

<p>DVI - DVI MONITOR KABL SA FERITIMA DVI MUŠKI – DVI MUŠKI</p>					
Tip	Opis	Cena			
192	singl link	15,00			
193	dual link	18,00			
<p>DVI - DFP MONITOR KABL SA FERITIMA DVI 18 – HPC 20 MUŠKI</p>					
Tip	Duzina (m)	Cena			
194	1,0	36,00			
<p>DVI - VGA MONITOR KABL SA FERITIMA DVI MUŠKI – SUBD HD 15 MUŠKI</p>					
Tip	Duzina (m)	Cena			
195	1,8	28,00			
<p>DVI - DFP MONITOR KABL SA FERITIMA DVI MUŠKI – HPC 26 MUŠKI</p>					
Tip	Duzina (m)	Cena			
196	1,8	36,00			

KABLOVI

KAB

KABLOVI ZA KOMPJUTERE KABKO

SCSI - I KABLOVI

SUBD 25 MUŠKI – CENTRONICS 50 MUŠKI

Tip	Duzina (m)	Cena
200	1,8	12,00

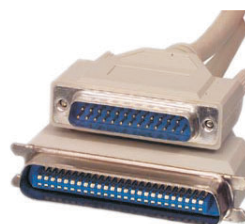

CENTRONICS 50 MUŠKI – CENTRONICS 50 MUŠKI

Tip	Duzina (m)	Cena
201	0,3	9,00
202	1,8	16,00
212	1,0	14,00



CENTRONICS 50 MUŠKI – CENTRONICS 50 ZENSKI

Tip	Duzina (m)	Cena
203	1,8	16,00



SCSI - II KABLOVI

**MINI SUBD HD 68 MUŠKI – MINI SUBD HD 68 MUŠKI
DUPLO OKLOPLJENI KABL**

Tip	Duzina (m)	Cena
205	2,0	58,00



**MINI SUBD HD 68 MUŠKI – CENTRONICS 50 MUŠKI
DUPLO OKLOPLJENI KABL**

Tip	Duzina (m)	Cena
207	2,0	38,00



KABLOVI ZA KOMPJUTERE KABKO

SCSI - II KABLOVI

MINI SUBD HD 68 MUŠKI – MINI SUBD HD 50 MUŠKI			
Tip	Duzina (m)	Cena	
208	2,0	42,00	
MINI SUBD HD 68 MUŠKI – SUBD 25 MUŠKI			
Tip	Duzina (m)	Cena	
209	2,0	26,00	
MINI SUBD HD 50 MUŠKI – CENTRONICS 50 MUŠKI			
Tip	Duzina (m)	Cena	
210	1,0	28,00	
211	1,8	36,00	
MINI SUBD 50 MUŠKI – SUBD 25 MUŠKI			
Tip	Duzina (m)	Cena	
215	1,5	26,00	
MINI SUBD 50 MUŠKI – MINI SUBD 50 MUŠKI			
Tip	Duzina (m)	Cena	
216	1,8	38,00	
MINI SUBD HD 68 MUŠKI – CENTRONICS 50 MUŠKI			
Tip	Duzina (m)	Cena	
217	2,0	38,00	

KABLOVI**KAB****KABLOVI ZA KOMPJUTERE KABKO****KABLOVI ZA MODEME****SUBD 25 MUŠKI – SUBD 9 ZENSKI**

Tip	Duzina (m)	Cena
106	0,3	4,00
107	1,8	6,00
109	3,0	7,00

**APPLE MACINTOSH KABLOVI****SUBD 25 MUŠKI – MINI DIN 8 MUŠKI**

Tip	Duzina (m)	Cena
230	1,8	8,00

**MINI DIN 8 MUŠKI – MINI DIN 8 MUŠKI**

Tip	Duzina (m)	Cena
231	1,8	8,00

**SUBD HD 15 MUŠKI – SUBD HD 15 ZENSKI
IBM – APPLE MACINTOSH ADAPTER**

Tip	Duzina (m)	Cena
240	1,8	26,00



KABLOVI ZA KOMPJUTERE KABKO**KABLOVI ZA JOYSTICK****JOYSTICK Y KABL
SUBD 15 MUŠKI – 2 X SUBD 15 ZENSKI**

Tip	Duzina (m)	Cena
179	0,2	8,00
179/2	2,0	14,00

**GAMEPORT MIDI KABL
SUBD 15 MUŠKI + ZENSKI – 2 X DIN 5 MUŠKI**

Tip	Duzina (m)	Cena
180	1,8	36,00

**JOYSTICK EXTENSION KABL
SUBD 15 MUŠKI – SUBD 15 ZENSKI**

Tip	Duzina (m)	Cena
181	1,8	8,00
181/3	3,0	12,00
181/5	5,0	14,00

**JOYSTICK KABL
SUBD15 MUŠKI – SUBD 15 MUŠKI**

Tip	Duzina (m)	Cena
182	1,8	8,00
182/3	3,0	12,00
182/5	5,0	14,00



UNUTRAŠNJI KABLOVI

SCSI 4 X 50 PINA IDC ZENSKI

Tip	Duzina (m)	Cena
213	0,6	8,00



SCSI 4X50 PINA IDC ZENSKI – CENTRONICS 50 ZENSKI

Tip	Duzina (m)	Cena
214	1,0	18,00



ULTRA DMA IDE 66/100 DATA KABL

Tip	Duzina (m)	Cena
225	0,4	12,00



**STANDARD IDE DATA KABL ZA HDD,CD-ROM,
 ZIP DRIVERS (IDE) CD BURNER**

Tip	Duzina (m)	Cena	
226/1	0,7	4,00	1 Ide Device
226/2	0,5	4,00	2 Ide Device



UNUTRAŠNJI KABLOVI

<p>FLOPPY DATA KABL 2X3,5" FDD</p> <table border="1"> <thead> <tr> <th>Tip</th> <th>Duzina (m)</th> <th>Cena</th> </tr> </thead> <tbody> <tr> <td>227</td> <td>0,7</td> <td>4,00</td> </tr> </tbody> </table>	Tip	Duzina (m)	Cena	227	0,7	4,00	
Tip	Duzina (m)	Cena					
227	0,7	4,00					
<p>EXTENSION KABL 5,25" MUŠKI – 5,25" ZENSKI</p> <table border="1"> <thead> <tr> <th>Tip</th> <th>Duzina (m)</th> <th>Cena</th> </tr> </thead> <tbody> <tr> <td>250</td> <td>0,2</td> <td>2,50</td> </tr> </tbody> </table>	Tip	Duzina (m)	Cena	250	0,2	2,50	
Tip	Duzina (m)	Cena					
250	0,2	2,50					
<p>EXTENSION KABL 5,25" ZENSKI – 3,5" ZENSKI</p> <table border="1"> <thead> <tr> <th>Tip</th> <th>Duzina (m)</th> <th>Cena</th> </tr> </thead> <tbody> <tr> <td>250/1</td> <td>0,2</td> <td>2,50</td> </tr> </tbody> </table>	Tip	Duzina (m)	Cena	250/1	0,2	2,50	
Tip	Duzina (m)	Cena					
250/1	0,2	2,50					
<p>EXTENSION KABL 3,5" MUŠKI – 3,5" ZENSKI</p> <table border="1"> <thead> <tr> <th>Tip</th> <th>Duzina (m)</th> <th>Cena</th> </tr> </thead> <tbody> <tr> <td>250/2</td> <td>0,2</td> <td>2,50</td> </tr> </tbody> </table>	Tip	Duzina (m)	Cena	250/2	0,2	2,50	
Tip	Duzina (m)	Cena					
250/2	0,2	2,50					
<p>KABL ZA NAPAJANJE FLOPPY 5,25" MUŠKI – 5,25" ZENSKI + 3,5" ZENSKI</p> <table border="1"> <thead> <tr> <th>Tip</th> <th>Duzina (m)</th> <th>Cena</th> </tr> </thead> <tbody> <tr> <td>251</td> <td>0,3</td> <td>3,00</td> </tr> </tbody> </table>	Tip	Duzina (m)	Cena	251	0,3	3,00	
Tip	Duzina (m)	Cena					
251	0,3	3,00					

UNUTRAŠNJI KABLOVI

FLOPPY DATA FLET KABL 3,5"+ 5,25"

Tip	Duzina (m)	Cena
252	1,0	7,00



**KABL ZA NAPAJANJE
 5,25" MUŠKI – 2 X 5,25' ZENSKI**

Tip	Duzina (m)	Cena
253	0,2	3,50

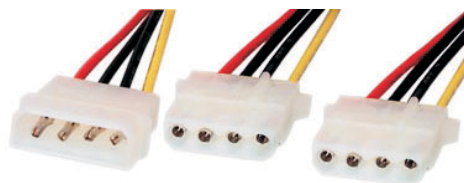

**KABL ZA NAPAJANJE
 5,25" MUŠKI – 2 X 3,5' ZENSKI**

Tip	Duzina (m)	Cena
254	0,8	5,00







HARD DISK KONTROLER KABL 40 PINA

Tip	Duzina (m)	Cena
255	0,8	5,00

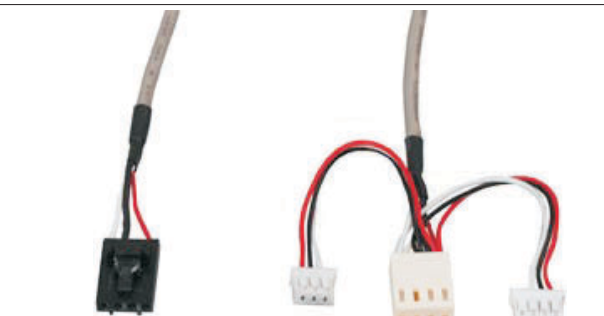

UNUTRAŠNJI KABLOVI

<p>ATX BOARD EXTENSION KABL</p> <table border="1"> <thead> <tr> <th>Tip</th> <th>Duzina (m)</th> <th>Cena</th> </tr> </thead> <tbody> <tr> <td>256</td> <td>0,2</td> <td>9,00</td> </tr> </tbody> </table>	Tip	Duzina (m)	Cena	256	0,2	9,00	
Tip	Duzina (m)	Cena					
256	0,2	9,00					
<p>CD-ROM AUDIO KABL M 2M – M 2M</p> <table border="1"> <thead> <tr> <th>Tip</th> <th>Duzina (m)</th> <th>Cena</th> </tr> </thead> <tbody> <tr> <td>265</td> <td>0,4</td> <td>3,00</td> </tr> </tbody> </table>	Tip	Duzina (m)	Cena	265	0,4	3,00	
Tip	Duzina (m)	Cena					
265	0,4	3,00					
<p>CD-ROM AUDIO KABL UNIVERZALNI</p> <table border="1"> <thead> <tr> <th>Tip</th> <th>Duzina (m)</th> <th>Cena</th> </tr> </thead> <tbody> <tr> <td>266</td> <td>0,4</td> <td>6,00</td> </tr> </tbody> </table>	Tip	Duzina (m)	Cena	266	0,4	6,00	
Tip	Duzina (m)	Cena					
266	0,4	6,00					
<p>USB SLOT KABL 2 X USB A ZENSKI – 2 X 5 PIN ZENSKI</p> <table border="1"> <thead> <tr> <th>Tip</th> <th>Duzina (m)</th> <th>Cena</th> </tr> </thead> <tbody> <tr> <td>01</td> <td>0,2</td> <td>8,00</td> </tr> </tbody> </table>	Tip	Duzina (m)	Cena	01	0,2	8,00	
Tip	Duzina (m)	Cena					
01	0,2	8,00					

KABLOVI ZA KOMPJUTERE KABKO

KABLOVI ZA KOMPJUTERE USB KABKO-USB

USB A MUŠKI – USB A MUŠKI

Tip	Duzina (m)	Cena
140	1,8	6,00
140 / 3	3,0	8,00
140 / 5	5,0	10,00



USB A MUŠKI – USB B MUŠKI

Tip	Duzina (m)	Cena	
141	1,8	6,00	1:1 normal
141 / 3	3,0	8,00	1:1 normal
141 / 5	5,0	12,00	1:1 normal
141HS	1,8	8,00	2,0 High Speed
141HS / 3	3,0	10,00	2,0 High Speed
141HS / 5	5,0	14,00	2,0 High Speed



USB B MUŠKI – USB B MUŠKI

Tip	Duzina (m)	Cena
142	1,8	6,00
142 / 3	3,0	8,00



USB A MUŠKI – USB A ZENSKI

Tip	Duzina (m)	Cena	
143	1,8	8,00	1:1 normal
143 / 3	3,0	11,00	1:1 normal
143HS	1,8	9,00	2,0 High Speed
143HS / 3	3,0	12,00	2,0 High Speed



USB A MUŠKI - MINI USB

Tip		Duzina (m)	Cena	
4 pina	5 pina			
160	161	1,8	12,00	2,0 High Speed
160 / 3	161 / 3	3,0	15,00	2,0 High Speed
160 / 5	161 / 5	5,0	18,00	2,0 High Speed



TELEFONSKI KABLOVI KABTE

Tehnički podaci:

Primena: Za ostvarivanje veza kod telekomunikacionih uređaja za spojeve u kojima su izloženi čestim većim pokretima i savijanjima

Konstrukcija: Provodnici su od finožičnog meko ozarenog bakra konstrukcije ϕ 18x0,10mm Izolacija i plašt su od PVC mase

Nazivni napon: 250 V

Ispitni napon: 1000 V

Temperaturni opseg: -10°C ... +70°C

TELEFONSKI KABLOVI – OKRUGLI KABTE-TGP



Tip	Cena	Debljina izolacije (mm)	Debljina plašta (mm)	Spoljašnji prečnik (mm)	Tezina "CuAg" zica (kg/km)	Ukupna tezina (kg/km)
2	0,60	0,27	0,8	4,0	1,20	16,6
4	0,80	0,27	0,8	4,6	2,40	23,0

TELEFONSKI KABLOVI – TRAKASTI KABTE-PGA



Tip	Cena	Broj zica (n)	Dimenzije (mm)	(mm)
4	0,30	4	7 x 0,11	2,5 x 5,0
6	0,90	6	7 x 0,11	2,5 x 5,0
8	1,20	8	7 x 0,11	2,5 x 5,0

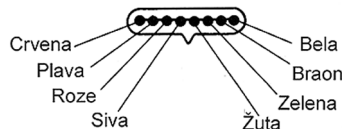
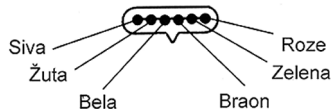
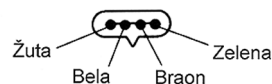

TELEFONSKI KABLOVI KABTE**TELEFONSKI KABLOVI – KOMPLET KABTE****PRODUZNI KABLI SA UTIKAČIMA 6/4**

Tip	Duzina (m)	Cena
011	2,0	1,50
012	5,0	2,50
013	10	4,00

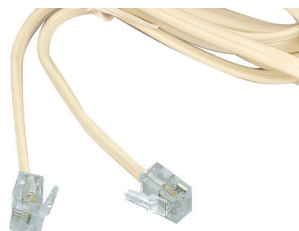
**PRODUZNI SPIRALNI KABLI SA UTIKAČIMA 6/4**

Tip	Duzina (m)	Cena
014	2,0	2,50
015	5,0	5,00
016	15	10,00

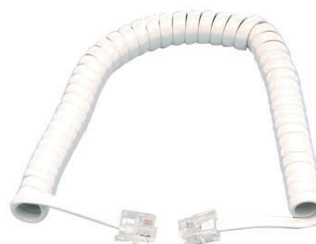
**SPIRALNI KABLI ZA SLUŠALICE SA UTIKAČIMA 4/4**

Tip	Duzina (m)	Cena
017	2,0	3,50
018	5,0	6,00

**PRODUZNI KABL SA UTIKAČIMA M 6/4 – Z 6/4**

Tip	Duzina (m)	Cena
019	5,0	4,00
020	7,5	5,00
021	15	9,00



TELEFONSKI KABLOVI KABTE**TELEFONSKI KABLOVI – KOMPLET KABTE****PRODUZNI SPIRALNI KABLI SA UTIKAČIMA M 6/4 – Z 6/4**

Tip	Duzina (m)	Cena
022	5,0	6,00
023	7,5	9,00

**PRODUZNI KABLI SA UTIKAČIMA M 6/4 – 2 x Z 6/4**

Tip	Duzina (m)	Cena
024	5,0	5,00
025	7,5	6,00
026	15	9,00

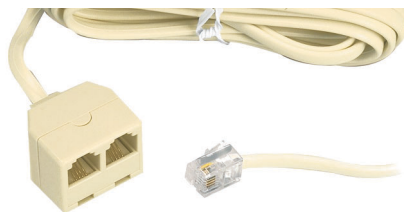
**PRODUZNI KABLI SA UTIKAČEM 6/4 I UŠICAMA**

Tip	Duzina (m)	Cena
027	2,0	1,50
028	5,0	3,00
029	15	7,00

**PRODUZNI RAZVODNI KABL M 6/4 – 5 x Z 6/4**

Tip	Duzina (m)	Cena
030	2,0	10,00



UVODNICI ZA KABLOVE KABUV

PG UVODNICI KABUVPG

Tip	Cena	Dimenzije u mm							
		∅	SW	A	B	C _{max}	C _{min}	D	E
V07	1,70	12,5	15	16,2	7,0	22,5	19,0	8	13,0
V09	1,80	15,2	19	21,2	8,5	26,0	21,0	8	15,5
V11	2,20	18,6	22	24,5	10,5	29,0	22,5	8	17,5
V13	2,40	20,4	24	26,5	12,5	30,0	23,5	9	18,0
V16	2,60	22,5	27	29,8	14,5	32,5	25,0	10	18,6
V21	3,80	28,3	33	36,0	18,5	36,5	29,0	11	22,5

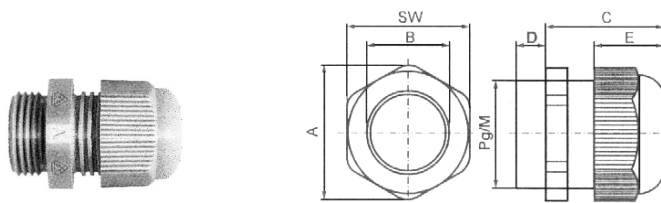

Tip	Cena	Dimenzije u mm							
		∅	SW	A	B	C _{max}	C _{min}	D	E
K07	3,00	12,5	15	16,2	7,0	56	53	8	45
K09	3,30	15,2	19	21,2	8,5	66	64	8	56
K11	3,90	18,6	22	24,5	10,5	80	76	8	68
K13	4,20	20,4	24	26,5	12,5	91	85	9	78
K16	4,80	22,5	27	29,8	14,5	104	97	10	90
K21	8,60	28,3	33	36,0	18,5	118	112	11	102

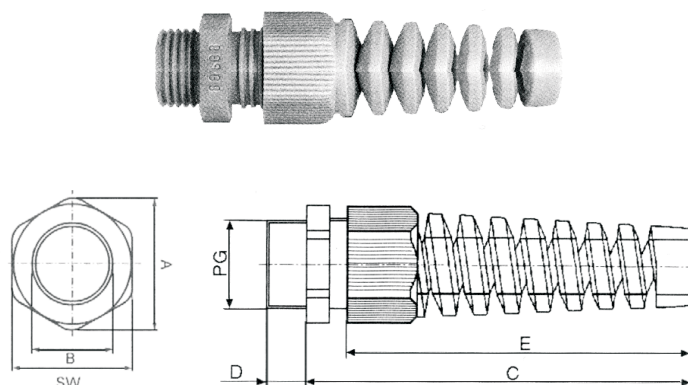

KABLOVI

KAB

UVODNICI ZA KABLOVE KABUV

GUMENI UVODNICI KABUVG

ZA KABLOVE ϕ 7mm

ZA KABLOVE RG 58/59

Tip	Cena
01	0,40



Tip	Cena
02	0,70

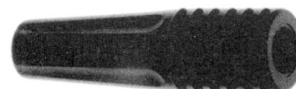

GUMENI PRSTENOVNI – UVODNICI KABUVGP

Tip	Cena	Dimenzije u mm				
		D	B	d	H	h
04	0,16	9	4	6	5,0	1,5
06	0,18	12	6	8	5,0	1,5
08	0,20	13	8	10	5,0	1,5
10	0,22	15	10	12	5,0	1,5

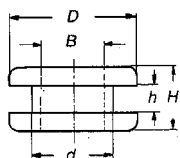

PVC PRSTENOVNI – UVODNICI KABUVPP

Tip	Profil	mm	
		od	do
1	ravan	2,3 x 4,5	2,8 x 5,3
2	ravan	3,0 x 7,1	3,8 x 7,6
3	okrugao	6,2	7,4
4	okrugao	8,2	9,2

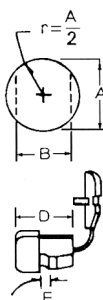

Tip	Cena	Dimenzije u mm				
		Otvor A	Otvor B	Duzina D	od	do
1	0,15	9,5	8,7	10,3	1,8	3,2
2	0,20	12,7	11,8	10,3	1,8	2,5
3	0,25	12,7	11,5	11,0	1,8	2,5
4	0,30	15,9	14,0	14,8	1,9	3,2

OBUJMICE ZA KABLOVE KABO

SA EKSEROM KABOE PLASTICNE KABOP

Tip	Cena	ϕ	Tip	Cena	ϕ
04	0,05	4	3,2	0,20	3,2
06	0,05	6	5,9	0,25	5,9
08	0,10	8	6,7	0,25	6,7
10	0,15	10-14	9,1	0,30	9,1
16	0,25	16-21	9,5	0,35	9,5
			12,7	0,40	12,7

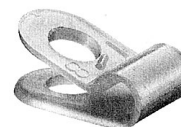
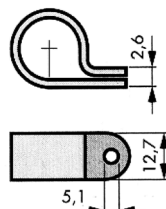

KABLOVI

KAB

DRŽAČI ZA KABLOVE KABD RAVNI KABDR

Tip	Cena	Dimenzije u mm				
		Profil	Otvor	Širina	Visina	Duzina
01	0,10	okrugli	14,0	3,2	5,5	20
02	0,11	okrugli	16,0	4,4	7,3	23
03	0,12	okrugli	16,5	4,4	7,5	24
04	0,15	ravan	17,0	4,4	7,0	24



OKRUGLI KABDO

Tip	Cena	Dimenzije u mm			
		ϕ	A	B	C
06	0,50	6	25,8	13,4	9,1
09	0,60	9	29,4	13,4	14,0
12	0,70	12	35,5	16,4	16,5

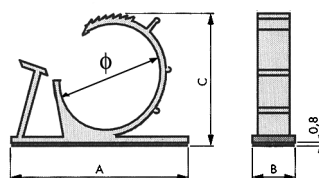

ZA FLET I TRAKASTE PROVODNIKE KABDF

Tip	Cena	Dimenzije u mm		
		A	B	C
15	0,25	15	26	6,5
20	0,30	20	26	6,5
25	0,40	25	26	6,5
30	0,50	30	26	6,5

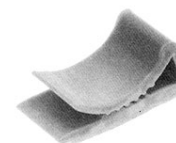
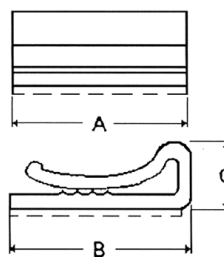

VEZICE ZA STEZANJE KABLOVA KABDV

Tip	Cena	L (mm)	B (mm)	ϕ (mm)	(kP)
1	0,05	98	2,5	≤ 21	8,2
2	0,10	140	3,6	≤ 35	13,0
3	0,12	160	2,6	≤ 40	8,2
4	0,15	200	4,8	≤ 50	22,0

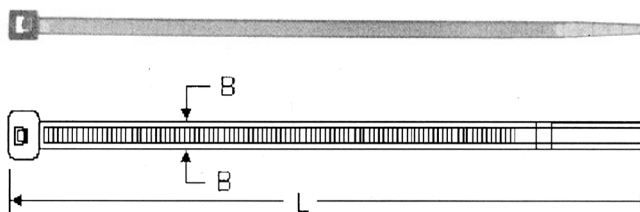

DRŽAČ VEZICE ZA STEZANJE KABLOVA KABDDV

Tip	Cena	Dimenzije u mm		
		A	B	C
101	0,30	21	4,7	3,5
102	0,40	28	5,0	4,0

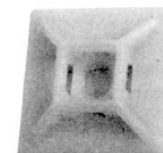
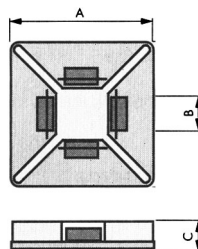

18000 Niš, Jovana Ristića 7, P.O.Box 135, Tel: 018 / 520-455, 522-814, 522-965, fax: 522-660
<http://www.MGelectronic.co.yu> e-mail: office@MGelectronic.co.yu

KABLOVI

KAB

UŠICE ZA PROVODNIKE KABUS

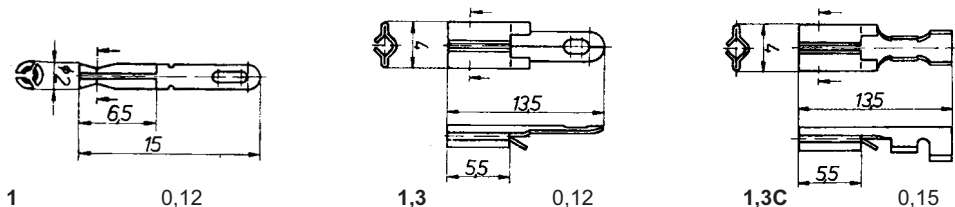

KABLOVSKE STOPICE KABST

KABLOVSKE STOPICE BEZ IZOLACIJE KABST

Debljina kabela - provodnika

	(0,5-1,5)		(1,5-2,5)		Dim. u mm				
	Tip	Cena	Tip	Cena	A	B	C		
O OKASTE DIN 46225	3-1	0,15	3-2	0,18	3,2	8,0	18,3		
	4-1	0,18	4-2	0,20	4,3	8,0	22		
	5-1	0,20	5-2	0,25	5,3	9,5	24		
V VILJUŠKASTE DIN 46225	3-0,5	0,12			3,2	6,4	18,3		
	3-1	0,18	3-2	0,18	3,2	6,4	22		
	4-1	0,18	4-2	0,20	4,3	7,2	22		
Z ZENSKE BEZ JEZIČKA DIN 46247	2,8-0,5	0,12			3,2	7,7	19		
	2,8-1	0,12			3,2	7,7	19,3		
	4,8-1	0,15			5,0	7,7	19,3		
	6,3-1	0,15	6,3-2	0,15	6,6	7,7	19,3		
ZJ ZENSKE SA JEZIČKOM DIN 46340	6,3-1	0,15	6,3-2	0,15	6,6	7,7	19,2		
ZM ZENSKO MUŠKE DIN 46345			6,3-2	0,30	6,6	7,7	19,2		
					6,3	7,7	19,2		
MK MUŠKE KRAĆE DIN 46248			6,3-2	0,25	6,3	8,0	19,6		
MD MUŠKE DUŽE DIN 46343	6,3-1	0,20	6,3-2	0,20	6,3	15,8	28		

KABLOVI

KAB

KABLOVSKE STOPICE KABST

KABLOVSKE STOPICE SA IZOLACIJOM KABSTI

Debljina kablova - provodnika

	Crvena (0,5-1,5)		Plava (1,5-2,5)		Dim. u mm			
	Tip	Cena	Tip	Cena	A	B		
O OKASTE	3-1	0,25	3-2	0,30	3,2			
	4-1	0,25	4-2	0,30	4,3			
	5-1	0,25	5-2	0,35	5,3			
	6-1	0,30	6-2	0,35	6,4			
			8-2	0,40	8,4			
V VILJUŠKASTE	3-1	0,25	3-2	0,30	3,2	6,4		
	4-1	0,30	4-2	0,35	4,3	7,2		
			5-2	0,40	5,3	9,5		
Z ZENSKE	2,8-1	0,30	2,8-2	0,40				
	4,8-1	0,30	4,8-2	0,40				
	6,3-1	0,30	6,3-2	0,40				
ZI ZENSKE SA IZOLACIJOM	6,3-1	0,35	6,3-2	0,45	6,6	0,8		
ZM ZENSKO MUŠKE	6,3-1	0,35	6,3-2	0,40	6,6	0,4		
M MUŠKE	6,3-1	0,30	6,3-2	0,40	6,3	0,8		
K ZA KRAJ KABLA	1	0,25	2	0,30	1,9	19		
N NASTAVAK	1	0,25	2	0,30	4,0	22,7		
					4,5	22,7		
ZO ZENSKE OKRUGLE	1	0,30	2	0,30	3,96			
					4,95			
MO MUŠKE OKRUGLE	1	0,30	2	0,30	3,96			
					4,95			

18000 Niš, Jovana Ristića 7, P.O.Box 135, Tel: 018 / 520-455, 522-814, 522-965, fax: 522-660
http://www.MGelectronic.co.yu e-mail: office@MGelectronic.co.yu

KABLOVSKE STOPICE KABST
KUĆIŠTA ZA KABLOVSKE STOPICE KABSTK

Tip	Cena	Opis	za stopice	Dim. u mm				
				B	C	L		
1A	0,25	izolac. navlaka	KABSTZ 6,3-1 KABSTZ 6,3-2	9	5	23,5		
1B	0,30	izolac. navlaka	KABSTZ 6,3-1 KABSTZ 6,3-2	9	4,6	25,3		
1Z	0,50	zadopolno zensko	KABSTMD 6,3-1 KABSTMD 6,3-2	12,4	9,2	31,8		
1M	0,50	jednopolno muško	KABSTZJ 6,3-1 KABSTZJ 6,3-2	10,0	6,7	24,1		
2Z	0,80	dvopolno zensko	KABSTMD 6,3-1 KABSTMD 6,3-2	15,1	13,2	31,8		
2M	0,80	dvopolno muško	KABSTZJ 6,3-1 KABSTZJ 6,3-2	13,0	10,0	22,9		
4Z	1,00	četvorpolno zensko	KABSTMD 6,3-1 KABSTMD 6,3-2	26,5	15,2	32,5		
4M	1,00	četvorpolno muško	KABSTZJ 6,3-1 KABSTZJ 6,3-2	23,3	15,4	24,1		
6Z	1,20	šestopolno zensko	KABSTMD 6,3-1 KABSTMD 6,3-2	31,3	17,8	32,5		
6M	1,20	šestopolno muško	KABSTZJ 6,3-1 KABSTZJ 6,3-2	28,5	13,8	24,2		
8Z	1,50	osmopolno zensko	KABSTMD 6,3-1 KABSTMD 6,3-2	40,4	18,5	33,0		
8M	1,50	osmopolno muško	KABSTZJ 6,3-1 KABSTZJ 6,3-2	37,9	13,7	24,1		

KABLOVSKE STOPICE KABST

ČAURE ZA KRAJ KABLA KABSTC

ČAURE BEZ IZOLACIJE

Tip	Debljina kabela	Cena	Dimenzije u mm			
			L	d ₁	d ₂	s
0,5	0,5	0,05	6	1,0	2,1	0,15
0,75	0,75	0,05	6	1,2	2,3	0,15
1,0	1,0	0,07	6	1,4	2,5	0,15
1,5	1,5	0,08	7	1,7	2,8	0,15
2,5	2,5	0,09	7	2,2	3,4	0,15
4,0	4,0	0,10	9	2,8	4,0	0,20

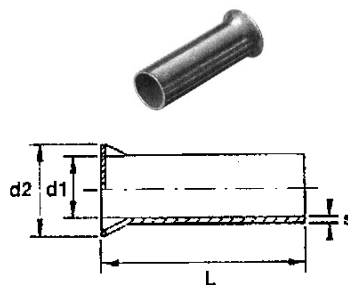

ČAURE SA IZOLACIJOM

Tip	Debljina kabela	Cena	Boja	Dimenzije u mm					
				L ₁	L ₂	d ₁	d ₂	s ₁	s ₂
I 0,5	0,5	0,10	bela	8	14	1,0	2,6	0,15	0,25
I 0,75	0,75	0,10	siva	8	14	1,2	2,8	0,15	0,25
I 1,0	1,0	0,12	crvena	8	14	1,4	3,0	0,15	0,25
I 1,5	1,5	0,13	crna	8	14	1,7	3,5	0,15	0,25
I 2,5	2,5	0,15	plava	8	14	2,2	4,2	0,15	0,25

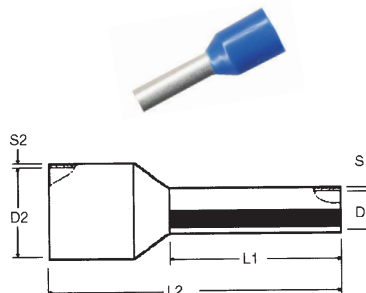

Napomena:

Klešta za krimpovanje kablovskih stopica nalaze se u poglavlju ALATI.

SABIRNI KONEKTORI KABSTKS

Tip	Cena	Opis
0,50	0,50	pet provodnika
0,75	0,60	šest provodnika



OZNAKE ZA OBELEZAVANJE KABLOVA KABOZ

Tip	Opis	Debljina provodnika	Cena
B1	brojevi	0,75-1,5	0,12
B2	brojevi	1,5-4,0	0,15
S1	slova	0,75-1,5	0,12
S2	slova	1,5-4,0	0,15

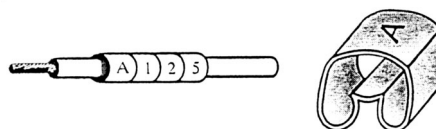

Brojevi: 1, 2, 3, 4, 5, 6, 7, 8, 9, 0

Slova: A, B, C, D, E, F, G, H, I, J, K

* Oznake su od PVC mase zute boje sa crnim brojevima ili slovima.

18000 Niš, Jovana Ristića 7, P.O.Box 135, Tel: 018 / 520-455, 522-814, 522-965, fax: 522-660
<http://www.MGelectronic.co.yu> e-mail: office@MGelectronic.co.yu

TERMO – BUZIRI ZA KABLOVE. KABBT
Tehnički podaci:

Zatezna čvrstoća: 18 MPa
 Istezanje: 450 %
 Temperaturni opseg: -55°C ... +125°C
 Minimalna temperatura sakupljanja: 120°C
 Promena duzine: ±10 %
 Probajni napon: 20 kV/mm
 Zapaljivost: Samogasiv, teško zapaljiv

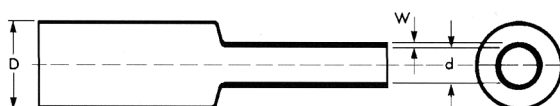

Tip	Cena po m	Boja	Dimenzije u mm		
			D _{min.}	d _{max.}	W _{nom.}
1,2	2,50	crna, crvena, plava, zuta	1,2	0,6	0,40
1,6	3,00	crna, crvena, plava, zuta	1,6	0,8	0,45
2,4	3,50	crna, crvena, plava, zuta	2,4	1,2	0,51
3,2	4,00	crna, crvena, plava, zuta	3,2	1,6	0,51
4,8	4,50	crna, crvena, plava, zuta	4,8	2,4	0,51
6,4	5,00	crna, crvena, plava, zuta	6,4	3,2	0,64
9,5	5,50	crna, crvena, plava, zuta	9,5	4,8	0,64
12,7	6,00	crna	12,7	6,4	0,64
16	7,00	crna	16,0	8,0	0,64
19	9,00	crna	19,0	9,5	0,78
25	15,00	crna	25,4	12,7	0,82
32	22,00	crna	32,0	16,0	0,82
38	24,00	crna	38,1	19,0	0,89
50	32,00	crna	50,8	25,4	0,95
76	46,00	crna	76,2	38,1	0,95

D = unutrašnji presek ekspanđiran, d = unutrašnji presek nakon zagrevanja, W = debljina zida

PVC BUZIRI ZA KABLOVE KABBP

Buzir creva sa debljinom zida od 0,4mm - 1,0 mm ima osnovnu namenu za izolaciju različitih vrsta kablova malih dimenzija u elektro i auto industriji.

Dozvoljenoodstupanje: $\pm 0,3$ mm.

Materijal: PVC

Tvrdoća: 50 - 90 ShA

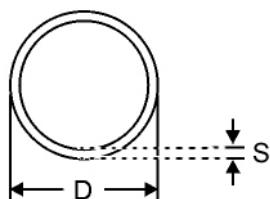

Tip	Cena po m	Tezina[g/m]	Tezina[m/kg]	Dimenzije u mm	
				D	S
1,5	0,10	3,2	312,5	1,5	0,4
2	0,15	3,9	256,4	2,0	0,4
3	0,20	5,6	178,6	3,0	0,4
4	0,25	9,2	109,0	4,0	0,5
5	0,30	12,0	83,0	5,0	0,5
6	0,35	14,5	67,0	6,0	0,5
7	0,40	16,5	61,0	7,0	0,5
8	0,50	23,0	43,5	8,0	0,6
9	0,70	28,0	35,5	9,0	0,7
10	0,80	31,0	32,0	10,0	0,7
12	0,90	38,0	26,3	12,0	0,7
18	1,80	78,0	12,8	18,0	1,0

D = spoljašnji presek, S = debljina zida

18000 Niš, Jovana Ristića 7, P.O.Box 135, Tel: 018 / 520-455, 522-814, 522-965, fax: 522-660
<http://www.MGelectronic.co.yu> e-mail: office@MGelectronic.co.yu