

TASTERI **Tas**

PRAVOUGAONI TASTERI
OKRUGLI TASTERI
MINI TASTERI
MINIJATURNI TASTERI
SUBMINIJATURNI TASTERI
PRINT TASTERI
IMPULS TASTERI
DATASWICH TASTERI
SMD TASTERI

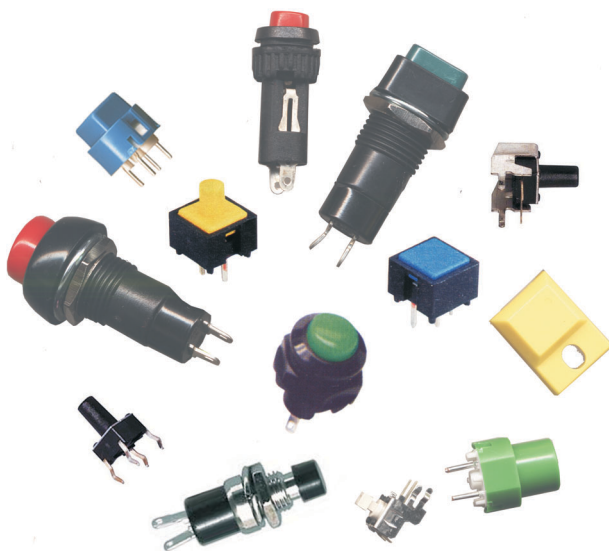

PRAVOUGAONI TASTERI TASP

Tehnički podaci:

Snaga uključivanja max:	3A /125 V AC
Otpornost kontakta:	< 20 mΩ
Otpornost izolacije:	100 mΩ
Ispitni napon:	1500 V AC
Radni vek:	>100 000

CR	crveni
CN	crni
PL	plavi
ZE	zeleni
ZU	Zuti

Cena: 1,50

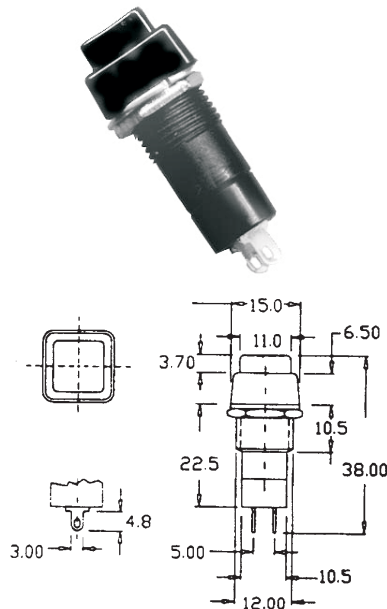

OKRUGLI TASTERI TASO

Tehnički podaci:

Snaga uključivanja max:	3A /125 V AC
Otpornost kontakta:	< 20 mΩ
Otpornost izolacije:	100 mΩ
Ispitni napon:	1500 V AC
Radni vek:	>100 000

CR	crveni
CN	crni
PL	plavi
ZE	zeleni
ZU	Zuti

Cena: 1,50

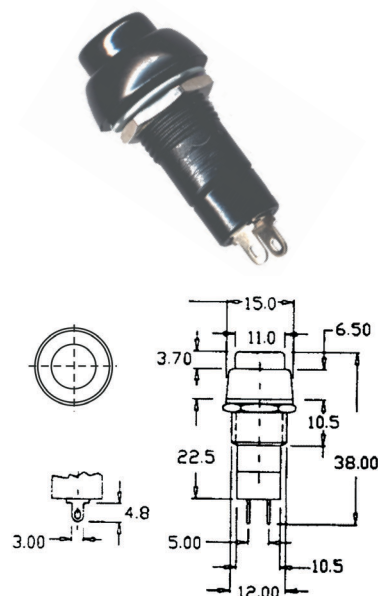

MINI TASTERI - OKRUGLI TASMO

Tehnički podaci:

Napon: 250V
 Struja: 1,5 A
 Otpornost kontakta: < 20 mΩ
 Otpornost izolacije: 100 mΩ
 Ispitni napon: 1500V AC
 Radni vek: >100000



CR crveni
CN crni
ZU Zuti
ZE zeleni

Cena: 2,50

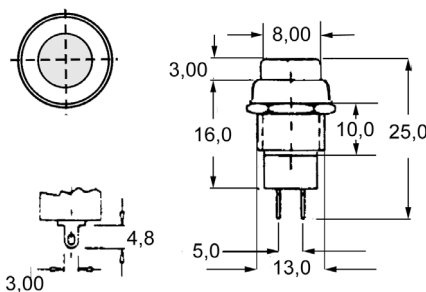

MINIJATURNI TASTERI TASMIN

Tehnički podaci:

Napon, max: 50 V DC
 Struja, max: 0,3 A
 Otpornost kontakta: ≤ 30 mΩ
 Otpornost izolacije: 500 MΩ
 Ispitni napon: 500 V AC
 Radni vek: 10.000



NORMALNO OTVORENI

NOCR crveni
NOCN crni
NOPL plavi
NOZU Zuti
NOZE zeleni
NOBE beli

Cena: 1,20

NORMALNO ZATVORENI

NZCR crveni
NZCN crni

Cena: 1,50

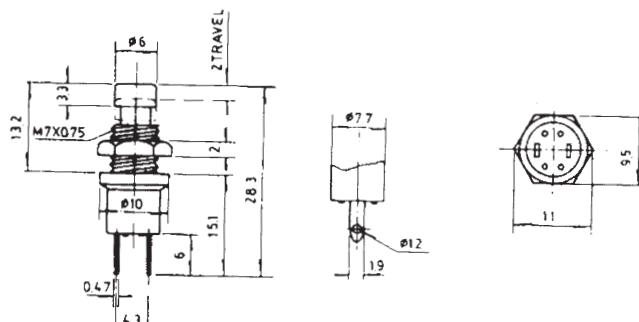

MINIJATURNI TASTERI TASMIN

PRAVOUGAONI TASMINP

Tehnički podaci:

Napon, max: 24 V DC
 Struja, max: 100 mA
 Kontakt: 1 radni
 Sila aktiviranja: 2 gr
 Radni vek: 40.000

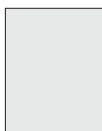

- CR** Crveni
- CN** Crni
- ZU** Zuti
- PL** Plavi
- BE** Beli

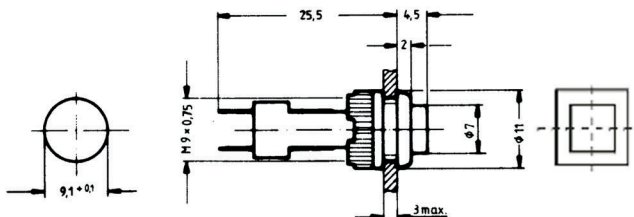

Cena: 1,20

OKRUGLI TASMINO

Tehnički podaci:

Napon, max: 24 V DC
 Struja, max: 100 mA
 Kontakt: 1 radni
 Sila aktiviranja: 2 gr
 Radni vek: 40.000



- CR** Crveni
- CN** Crni
- ZU** Zuti
- PL** Plavi
- BE** Beli

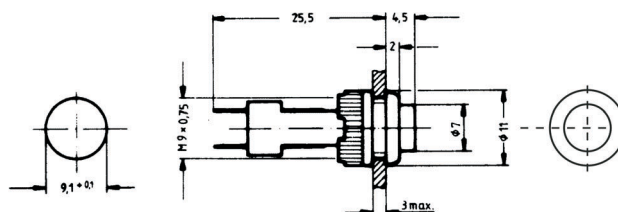

Cena: 1,20

SUBMINIJATURNI TASTERI. TASSM

Tehnički podaci:

Snaga uključivanja:	1A / 120 V AC ili 28 V DC
Radni vek:	60.000
Prelazni otpor:	< 20 mΩ
Otpornost izolacije	1000 MΩ
Probajni napon:	1000 V _{eff}
Temperaturni opseg:	-25 ... +70°C
Kontakti:	mesing posrebren

Kućište:

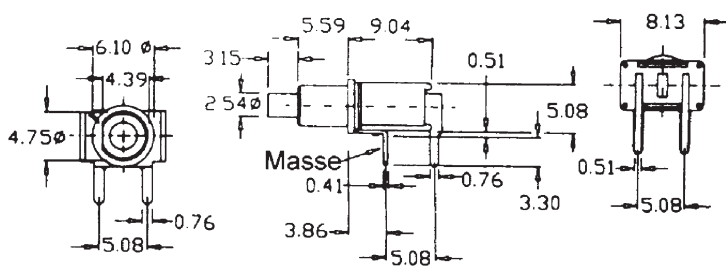
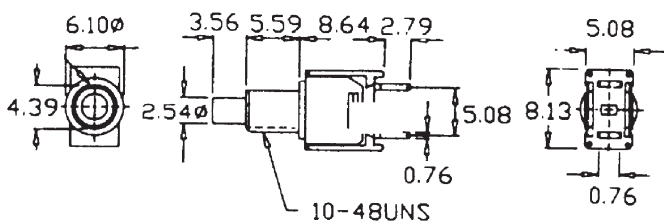
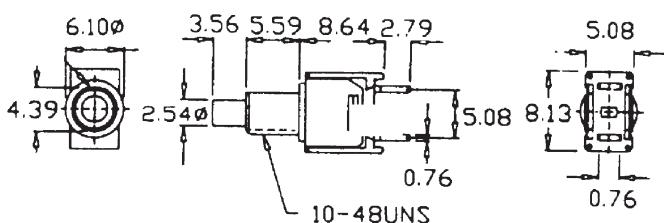

KAPICE ZA TASTERE

Tip	Boja
KCR	crvena
KCN	crna
KZE	zelena

Cena: 0,50



PRINT TASTERI TASPR

PRINT TASTERI TIP1, TIP2

Tehnički podaci:

Snaga uključivanja:	20 mA / 30V DC
Otpornost provođenja:	≤ 25 mΩ
Otpornost izolacije:	≥ 1GΩ
Temperaturni opseg:	-20...+70°C
Hod aktiviranja:	0,6 ± 0,1mm
Snaga aktiviranja:	0,82,5V
Prel:	≤ 0,5mS
Vek trajanja:	≥1.000.000 aktiviranja



TIP 1

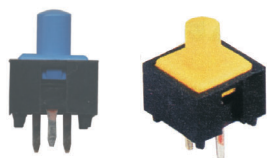

TIP 2

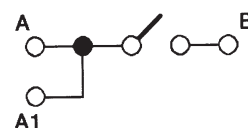
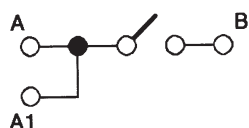
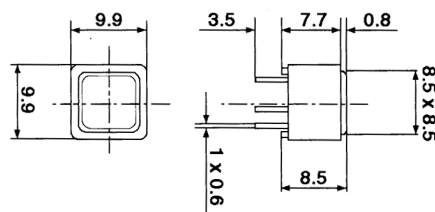
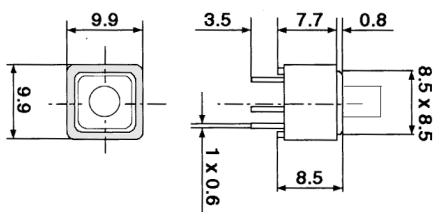
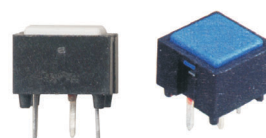

Tip	Boja	Cena
CR	crvena	1,00
CN	crna	1,00
PL	plava	1,00
SI	siva	1,00
ZU	Zuta	1,00

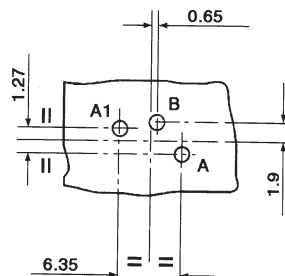
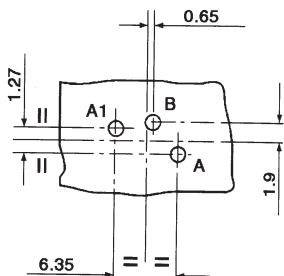

PRINT TASTERI **TASPR**
PRINT TASTERI D6 **TASPRD6**

Tehnički podaci:
Snaga uključivanja: 6 W AC / 0,35 W DC
Napon max: 100 V AC
Struja max: 100 mA AC
Ispitni napon: ≥ 1000 V
Radni vek: $\geq 2,5 \times 10^5$
Otpornost provođenja: ≤ 100 m Ω
Otpornost izolacije: $\geq 1 \times 10^{11}$ Ω
Sila aktiviranja: 1,3 N \pm 30. %
Hod aktiviranja: 0,8 mm
Temperaturni opseg: -20 ... +85°C

PRAVOUGAONI D6Q

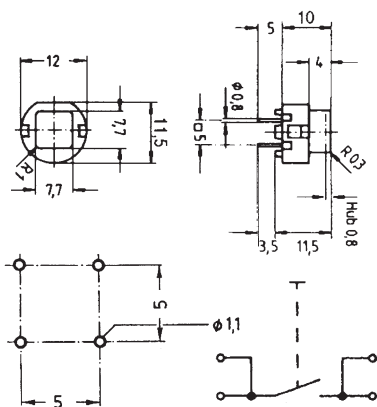

OKRUGLI D6R

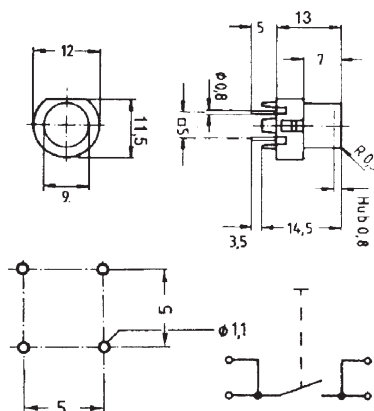

Tip	Boja	Cena
CR	crvena	1,50
CN	crna	1,50
PL	plava	1,50
ZU	Zuta	1,50
ZE	zelena	1,50
SI	siva	1,50
BE	bela	1,50

KAPE ZA TASTERE

Tip	Boja	Cena
KCR	crvena	Cena: 1,00
KCN	crna	
KSI	siva	

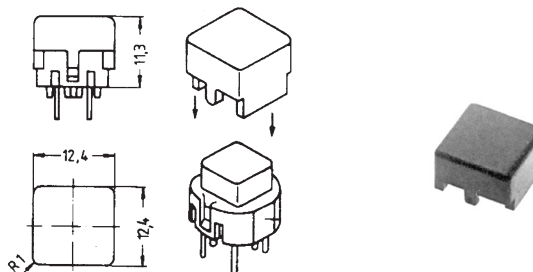

TASTERI

TAS

IMPULS TASTERI TASIM

Tehnički podaci:

Snaga uključivanja:	1,2 W	Kontakt:	1 radni
Napon, max:	24 V DC	Sila aktiviranja:	1N
Struja, max:	50 mΩ	Hod aktiviranja:	0,5 mm
Ispitni napon:	250 V AC	Kontakti:	mesing posređen
Radni vek:	100 000	Temperatura lemljenja, max:	255°C, 5 s
Otpornost kontakta:	100 mΩ	Temperaturni opseg:	-25 ... +70°C
Otpornost izolacije:	100 MΩ		

HORIZONTALNI TASIMH

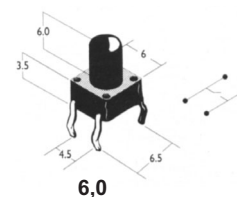
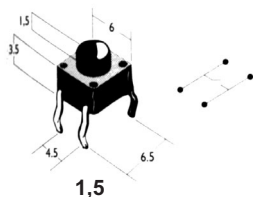
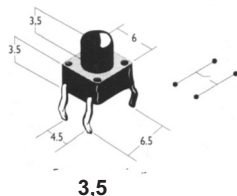
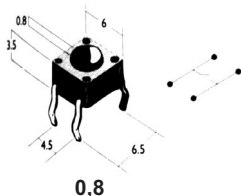

Cena: 0,60

VERTIKALNI TASIMV

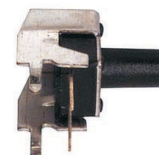
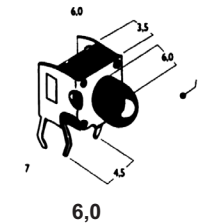
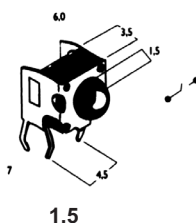
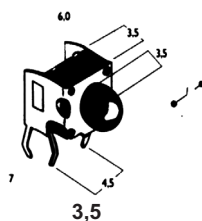
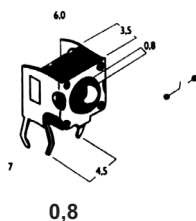

Cena: 0,60

IMPULS TASTERI TASIM

IMPULS TASTERI - OMRON TASIMO

Tehnički podaci:

Snaga uključivanja max: 1...50 mA / 5...24 V DC
 Napon, max: 30 V DC
 Ispitni napon: 500 V AC
 Kontakt: 1 radni
 Površina kontakta: srebro-platina
 Temperatura lemljenja, max: 250°C, 5 s
 Temperaturni opseg: -25 ... +70°C



1050, 1052

Tip	Cena	Radni vek	Sila (cN)	Hod (mm)
1050	0,60	10 ⁶	100	0,28
1052	0,60	3x10 ⁶	150	0,28
3150	0,70	10 ⁶	100	0,25
4000	0,80	3x10 ⁶	130	0,30

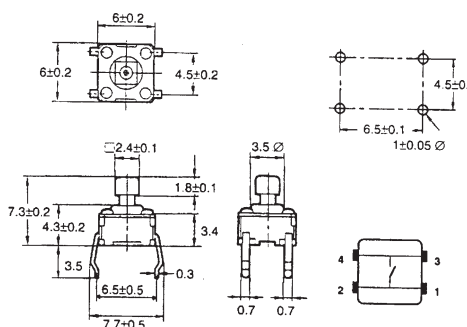

3150



4000

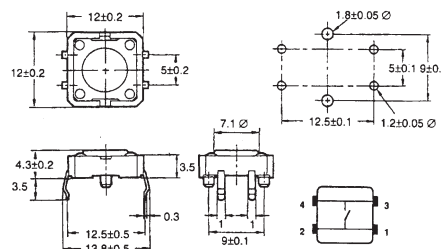
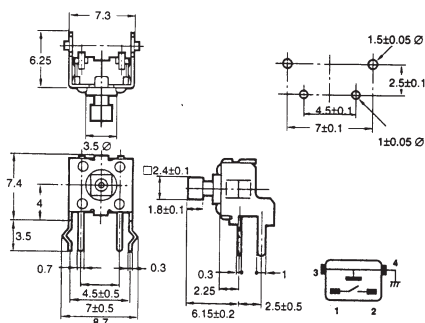

DATASWITCH TASTERI TASDS

Tehnički podaci:

Struja uključivanja, max:	10 mA DC
Napon uključivanja, max:	24V DC
Snaga, max DC:	240mW
Otpornost provođenja:	≤ 50 mΩ
Otpornost izolacije:	≤ 10 ⁴ MΩ
Kapacitivnost:	< 0,9 pF
Prel:	≤ 2 mS
Snaga aktiviranja:	2N
Hod aktiviranja:	≤ 3 mm
Vek trajanja:	≥ 5x10 ⁶
Temperaturni opseg:	-25...+85°C

TIP 1 TASDS1

Tip	Boja	Cena
CR	crveni	3,00
CN	crni	3,00
BE	beli	3,00
ZU	Zuti	3,00

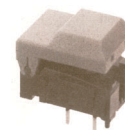
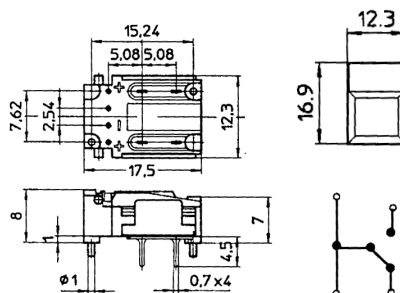

TIP 2 TASDS2
MODUL

Tip	Cena
M	2,50

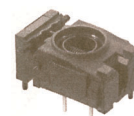
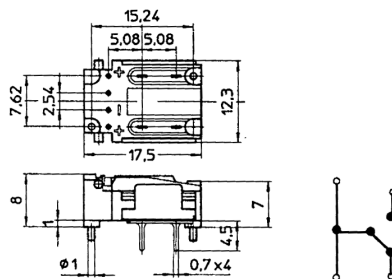

KAPA SA OTVOROM ZA LED DIODU Ø 3mm

Tip	Boja	Cena
KCR	crvena	0,60
KCN	crna	0,60
KZU	Zuta	0,60

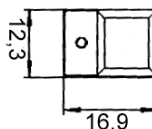

SMD TASTERI. SMDTAS

SMD TASTER TIP 1 TASSMD1

Tehnički podaci:

Snaga uključivana, max: 50 mA / 24 V DC
 Napon uključivanja, max: 30 V DC
 Ispitni napon, (1 min): 500 V DC
 Kontakti: 1 radni
 Radni vek: 500.000 aktiviranja
 Dužina aktiviranja: 0,25 mm
 Površina kontakta: Srebro – platinirano
 Temperatura lemljenja (max): 230°C, 10 s
 Temperaturni opseg: -25 ... 170°C

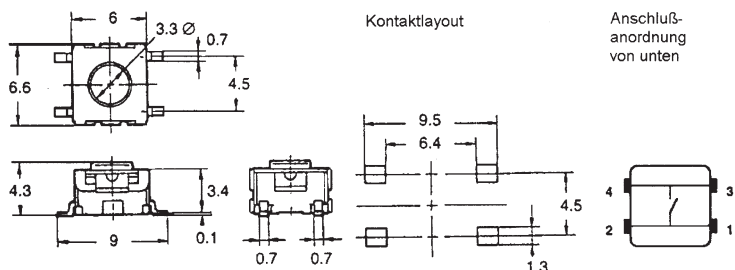
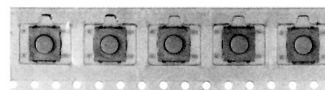

Cena: 1,20

SMD TASTER TIP 2 TASSMD2

Tehnički podaci:

Snaga uključivana, max: 50 mA / 12 V DC
 Napon uključivanja, max: 30 V DC
 Ispitni napon, (1 min): 250 V DC
 Kontakti: 1 radni
 Radni vek: 500.000 aktiviranja
 Dužina aktiviranja: 0,25 mm
 Površina kontakta: Srebro – platinirano
 Temperatura lemljenja (max): 260°C, 5 s
 Temperaturni opseg: -25 ... +70°C

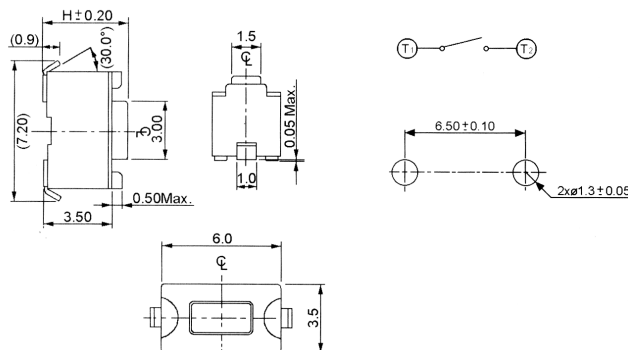

Cena: 1,20

SMD TASTERI. SMDTAS

SMD TASTER TIP 3 TASSMD3

Tehnički podaci:

Snaga uključivana, max: 50 mA / 24 V DC
 Napon uključivanja, max: 30 V DC
 Ispitni napon, (1 min): 250 V DC
 Kontakti: 1 radni
 Radni vek: 500.000 aktiviranja
 Dužina aktiviranja: 0,25 mm
 Površina kontakta: Srebro – platinirano
 Temperatura lemljenja (max): 260°C, 5 s
 Temperaturni opseg: -25 ... 170°C

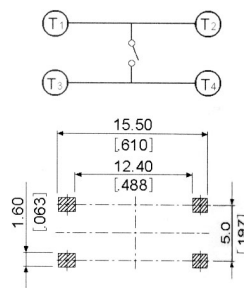
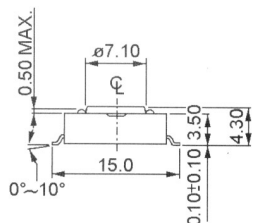
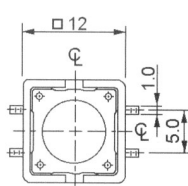

Cena: 1,50

SMD TASTER TIP 4 TASSMD4

Tehnički podaci:

Snaga uključivana, max: 50 mA / 12 V DC
 Napon uključivanja, max: 30 V DC
 Ispitni napon, (1 min): 250 V DC
 Kontakti: 1 radni
 Radni vek: 500.000 aktiviranja
 Dužina aktiviranja: 0,25 mm
 Površina kontakta: Srebro – platinirano
 Temperatura lemljenja (max): 260°C, 5 s
 Temperaturni opseg: -25 ... +70°C

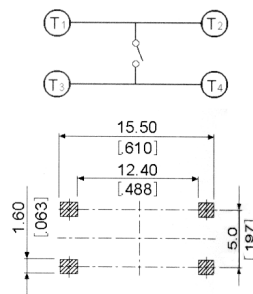
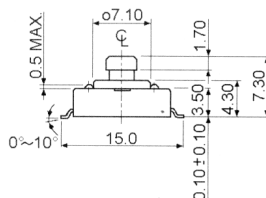
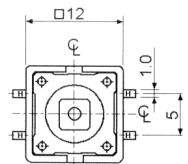
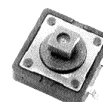

Cena: 1,50