

Part number

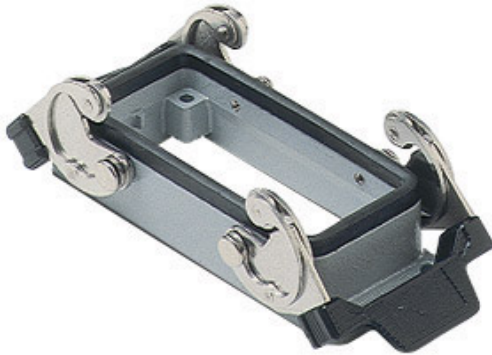

CHI 16



Brief description:

bulkhead mounting housings with 2 levers, size "77.27", metal version, IP66

Product description	
Version	metal version
Series	bulkhead mounting housings with 2 levers
Product type	with 2 levers
Family	CLASS enclosures
Size	size "77.27"
Technical data	
Material	metal
IP degree of protection	IP66 (and IP69K DIN 40050 - 9)
Further technical details	
Weight	128,00 g

Approvals / Standards	
Quality mark	 (type:4/4X/12),  , EAC
Conformity	CQC, CE
General ordering information	
EAN13 code	8015747017688
Tariff number	85369095
Packaging Information	
Packaging length	380,00 mm
Packaging height	230,00 mm
Packaging width	340,00 mm
Packaging weight	7,10 kg
Packaging volume	29,72 dm ³
Packaging description	Carton box
Packaging quantity	40 Pcs
Packaging EAN code	8015747017695
Sub-packaging weight	0,89 kg
Sub-packaging description	Plastic pakaging
Sub-packaging quantity	5 Pcs
Sub-packaging EAN barcode	8015747017701

Part number

CHI 16



Catalogue drawings

CHI

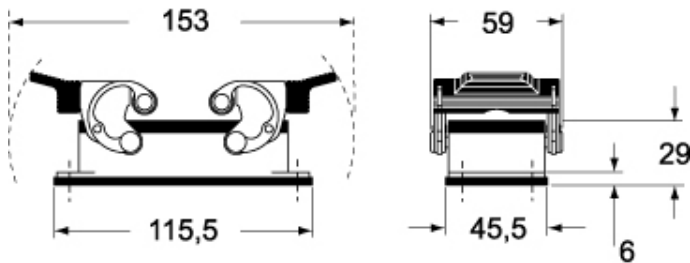

CHI C

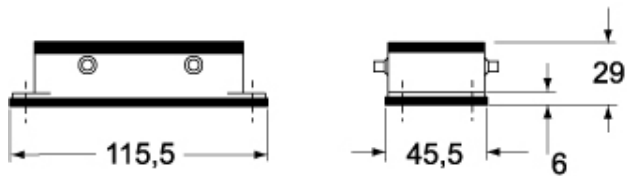

CHI CS/CP

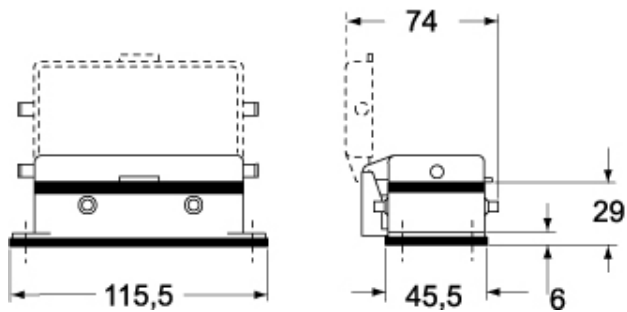

Catalogue drawings

