

LZ5342

Features

1. Rated Rating: 10A 125/250VAC
2. Dust proof, oil proof, water proof design(IP65)
3. Various actuator are available
4. High mechanical life and mechanical strength
5. High precision, fast action
6. CCC, CE approvals

Application Area

Widely applied in machinery, production line, elevator equipment etc.

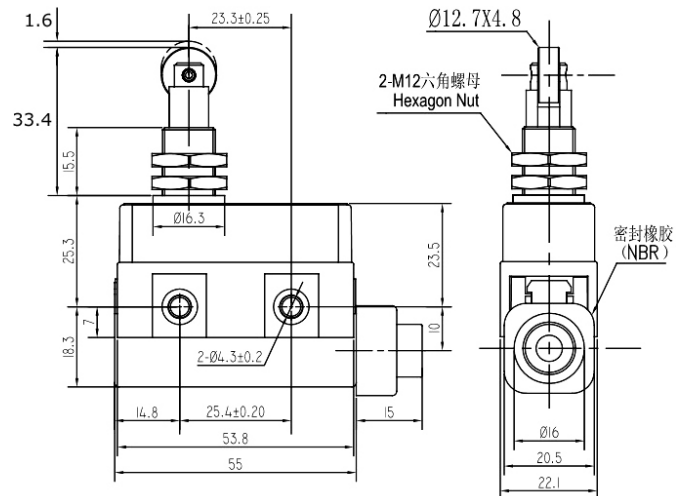

Rating		10A 125/250VAC 0.5A 125VDC
Initial contact resistance		25mΩ max.
Initial insulation resistance		100MΩ min. (at 500VDC)
Dielectric strength	Between non-consecutive terminals	1000Vrms, 50/60Hz for 1 min
	Between non-current carrying metal parts and each terminal	2000Vrms, 50/60Hz for 1 min
	Between ground and each terminal	2000Vrms, 50/60Hz for 1 min
Max.shock resistance	Destruction	1000m/s ² max.
	Malfunction	300m/s ² max.
Vibration resistance		10-55Hz, 1.5mm double amplitude
Operating life	Mechanical life	1,000,000 operations min.
	Electrical life	100,000 operations min.
Ambient temperature		-10°C to +85°C
Ambient humidity		95% RH max.
Operating frequency	Mechanical	120 operation/min
	Electrical	30 operation/min
Operating speed		0.01mm-50cm/s
Protection degree		IP65